

TOP
COLLECTIONS

TOP
INVESTMENT
COLLECTIONS

5^{*}
YEAR
WARRANTY

[PORTA]

CATALOGUE 2020

Porta LOFT



I CARE ABOUT THE WORLD I AM ECO -FRIENDLY

ON OUR WEBSITE

**PORTA.COM.PL/DO-POBRANIA
YOU CAN FIND ALL OF OUR
CATALOGUES, ALWAYS
UP TO DATE**



**OPEN UP TO ECOLOGY WITH US, CHOOSE
MOBILE VERSION OF THE CATALOGUE**



**WE CARE ABOUT THE ENVIRONMENT
WE PRODUCE RESPONSIBLY**

Table of contents

01 PAINTED INTERIOR DOORS

MINIMAX	10	
LONDON, VIENNA	12	
Porta ROYAL Premium	14	
Porta SCANDIA Premium	16	
Porta VECTOR Premium, Porta FORM Premium	18	
Porta FOCUS Premium	20	TOP
Porta DESIRE	22	TOP
Porta GRANDE - NEW MODEL	24	
Porta DUO - NEW	26	
Porta HIDE - NEW	28	

02 FRAME AND PANEL INTERIOR DOORS

SYNTHETIC VENEER

Porta Verte HOME A, B	32	
Porta Verte HOME C	34	TOP
Porta Verte HOME D	36	
Porta Verte HOME E, F	38	
Porta Verte HOME G	40	
Porta Verte HOME H - NEW	42	TOP
Porta Verte HOME J - NEW	44	
Porta Verte HOME L, N	46	
Porta Verte PREMIUM A, D	48	
Porta Verte PREMIUM B, C	50	
Porta Verte PREMIUM E - NEW	52	
Porta CONCEPT, group A and B	54	
Porta CONCEPT, group C	56	TOP
Porta CONCEPT, group H and K	58	
Porta BALANCE	60	
Porta HARMONY	62	
Porta INSPIRE, group A and B	64	TOP
Porta INSPIRE, group C	66	

03 FRAME AND PANEL INTERIOR DOORS

SYNTHETIC VENEER

Porta DECOR	70	TOP
Porta TWIST, Porta GRADDECO	72	
Porta STYL	74	
Porta FIT, group A, B, C, I	76	
Porta FIT, group E-H	78	
Porta NOVA group 2-5	80	
Porta NOVA group 6 and 7	82	
Porta LEVEL	84	
Porta LINE	86	
Porta CPL	88	TOP TOP INVESTMENT COLLECTIONS
Porta RESIST	90	
Porta FOCUS	92	
Porta LOFT - NEW	94	

04 INTERIOR DOORS. NATURAL VENEER

Nature CLASSIC	98	TOP INVESTMENT COLLECTIONS
Nature LINE	100	
Nature VECTOR - NEW	102	
Nature GRANDE	104	
Nature IMPRESS, Nature SPACE	106	
Nature CONCEPT	108	
MADRID, CORDOBA, TOLEDO	110	
Villadora RETRO	112	
Villadora MODERN	114	

05 FOLDING AND SLIDING DOORS

Folding doors ALFA, BETA	118
Sliding system PORTA, ALU	120
Sliding system COMPACT, METAL	122
Sliding system BLACK, SLIDE - NEW	124

06 TECHNICAL DOORS

Acoustic 27 dB, 32 dB	128	
SILENCE 37dB, EI30	130	TOP INVESTMENT COLLECTIONS
Acoustic 42 dB	132	
Fire-rated EI 30, EI 60	134	
ENDURO	136	TOP INVESTMENT COLLECTIONS
AQUA	138	

07 APARTMENT ENTRANCE DOORS

Entrance and technical doors - summary of the models	142
AGATE, OPAL - class RC 2	144
EXTREME - class RC 2 - NEW	146
Steel SAFE - class RC 2 and RC 3	148
QUARTZ - class RC 2	150
GRANITE - Anti-burglary class RC 3	152
EXTREME - Anti-burglary class RC 3	154
GRANITE - Anti-burglary class C	156

08 EXTERIOR ENTRANCE DOORS

Steel SAFE and ENERGY PROTECT	160	TOP INVESTMENT COLLECTIONS
Wooden Eco POLAR, Eco POLAR PASSIVE	162	

09 STEEL TECHNICAL DOORS

Doors for utility rooms, storage rooms	166
Steel BASIC, Steel exterior BASIC PLUS	168
Steel SOLID	170
Steel EI 30, EI 60	172

10 DOOR FRAMES

MINIMAX	176
Porta SYSTEM, Porta SYSTEM GK	178
Porta SYSTEM ELEGANCE	180
LEVEL	182
Porta RENOVA	184
Villadora RETRO, Villadora MODERN	186

11 STEEL DOOR FRAMES

Steel Porta SYSTEM - NEW	190	PORTASTEEL PRODUCT
Steel Adjustable, Steel Adjustable PS with 'sharp edges'	192	
Corner profile frame - SMALL PLUS;		
Corner profile frame - LARGE	194	TOP INVESTMENT COLLECTIONS
PROJECT BIS, PROJECT Premium	196	

12 ACCESSORIES, DIMENSIONS, ADDITIONAL INFORMATION

Handles - NEW	200
Skirting-boards and ventilation	206
Hinges, locks, other accessories	207
Technical drawings, Door dimensions	208
Durability levels of Porta finishes, finishes charts	216
Glass panels	225

Characteristics of our products

MEANING OF THE SYMBOLS THAT DESCRIBES OUR PRODUCTS' FEATURES



The most popular PORTA collections



Products recommended for investment projects.

DESIGN, GLAZING, MIRROR

You can choose a glass panel with different designs and level of transparency.



Design your door



Optional mirror



Natural veneer



Premium paint



UV paint

CONSTRUCTION

While choosing the type of construction you determine, inter alia, endurance, stability, sound proofness, and thermal insulation of your door.



Frame and panel construction



Burglar resistance
RC 2 class, RC 3 class, C class.
Resistance to unpermitted opening



Fire resistance
EI 30, EI 60
Ability to stop the fire for 30 or 60 minutes



Smoke control
class Sa, S₂₀₀
It defines door's tightness to smoke leakage



Acoustic insulation
Rw 27 dB D_{1,25}, Rw 32 dB D_{1,30},
Rw 37 dB D_{1,35}, Rw 42 dB D_{1,40}
It defines acoustic rating of a door



Resistance to weather conditions



Strength performance class
class 1, class 2, class 3, class 4
The performance levels in resisting various loads, impacts and torsions indicating normal usage for a range of categories of duty



Porta CONTRACT
Bespoke design, made to measure



DOOR FRAME

A door frame is as important part of a doorset as a door leaf. There are a lot of door frame types and choosing one, please consider that they may come in two options: rebated or non-rebated.



non-rebated



rebated



Project BIS,
Project Premium



Door frame adjustment available



Architraves available in two sizes: 60 mm and 80 mm



Retro module

DOOR LEAF

Door design may have different functional solutions depending on interior needs and functions.



Available sizes for a single door:
min. '60', max. '110'



Available sizes for a double door:
min. '90', max. '220'



Standard height
door leaf 2030



Increased height
door leaf 2200



Door leaf thickness
depends on chosen construction



Sliding door leaf



Reversible door
right-left

Please note ...

OUR DOORS ARE ANTI-BULGLARY

(RC 2) class - resistance class to provide basic protection against break-in attempts with use of simple tools e.g. a screwdriver, a wedge, pincers, a hammer.



(RC 3) class - resistance class to provide protection against break-in attempts with use of tools e.g. a crowbar, a cotter pin driver, a mechanical drill.



RC-resistance class it's the ability of certain product to withstand violent intrusion in protected rooms or areas.

Before purchasing a door you need to decide on the opening direction



SINGLE DOOR
LEFT DOOR LEAF

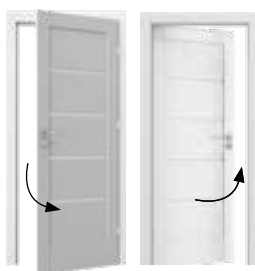

SINGLE DOOR
RIGHT DOOR LEAF

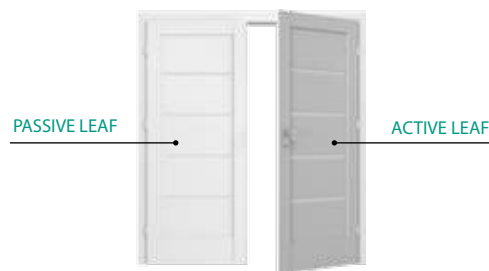

DOUBLE LEAF DOOR

CALCULATE THE DOOR PRICE

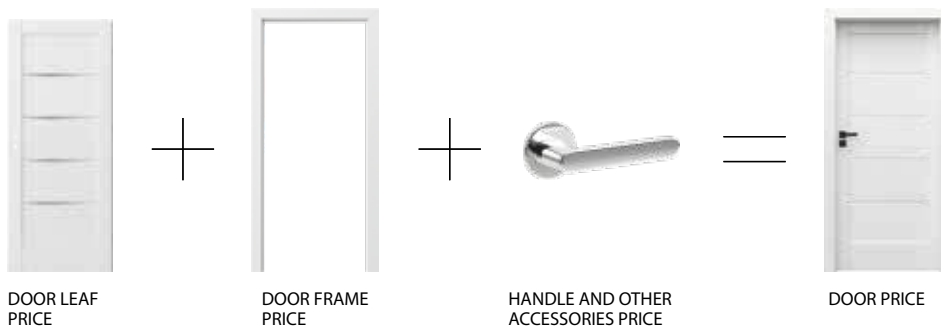

PRODUCTION TIME*

Check on www.portadoors.com

*production time may differ as it depends on the quantity and type of ordered products.

CHOOSE PORTA,
HIGHEST QUALITY
PRODUCT WITH AN
**AUTHENTICITY
MARK**



i Producer's mark is placed above the lock faceplate.

Porta System steel door frame

see page 190



**PORTASTEEL
PRODUCT**

**STEEL FRAME THAT WRAPS AROUND THE WALL
OPENING. IT'S ALSO ADJUSTABLE & EASY TO FIT.
ATTRACTIVE DESIGN.**

NEW IN FRAME AND PANEL LINE



Porta VERTE HOME J



Porta VERTE HOME H



Porta VERTE PREMIUM E



Porta GRANDE F

NEW COLLECTION



EXTREME RC 2 see page 146

NEW SYSTEM



Sliding system BLACK see page 124

NEW SOLUTION



Porta LEVEL see page 84

NEW COLLECTION



Porta DUO see page 26

NEW COLLECTION



Porta LOFT see page 94

NEW COLLECTION



Nature VECTOR see page 102

01

PAINTED INTERIOR DOORS

Painted doors - a perfect choice for those who appreciate simplicity having various options to choose from. Unobtrusive designs look good in any interior.



APPARENTLY I AM INDECISIVE BECAUSE I OFTEN CHANGE SOMETHING IN MY HOME. THAT'S WHY I HAVE CHOSEN CLASSIC DOORS, THAT WILL ALWAYS MATCH ANYTHING.



MINIMAX



MINIMAX P, White



MINIMAX P, White



model P



model M



model D



model L

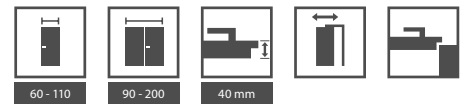

AVAILABLE FINISHES

Standard paint ★★★★★☆



glazing bead with a glass panel



'Chinchilla' glass

TECHNICAL INFORMATION

DOOR LEAF CONSTRUCTION

Honeycomb or hollow chipboard core reinforced with rails and stiles. The construction is skinned with HDF.

ACCESSORIES INCLUDED IN THE DOOR LEAF PRICE

- Two or three standard barrel hinges, PRIME set available ->see extra charges
- Three hinges for size '100' or '110'
- Lock: key lock, WC lock, or cylinder lock
- 'Chinchilla' glass or frosted tempered glass (optionally at an extra charge)
- Round pull handle (for sliding doors)

DOOR FRAMES

Recommended rebated door frames:

- Porta SYSTEM in Portadecor veneer see p. 178
- MINIMAX in Portadecor veneer see p. 176
- STEEL see p. 190-195

NOTES

- Technical Assessment AT-15-6515/2016, ITB Warsaw.
- **MINIMAX door leaf is available only in a rebated option.**
- Door leaves available in 'paint yourself' option are in the same price as MINIMAX white.
- **Hollow chipboard core and chipboard core have preparation for shortening as a standard**
- Size '110' is available only with hollow chipboard.
- Glazing size is the same as for size '100'
- Double doors are available in any door leaf size combinations.

- Passive door leaves (side panels) in sizes '30', '40', '50' available only in solid option (without glazing or decorative mouldings).
- Magnetic lock is not available for a double door.
- **Size '80' and '90' in investment norm (clear opening width 800, 900 mm) available as a standard- without extra charge.**
- Reinforcement for door closer requires third hinge.
- Due to various materials use, there might be a slight colour difference between door leaf and a glazing bead.

EXTRA CHARGES

- size '100', '110'
- hollow chipboard core
- ventilation grille, ventilation sleeves or ventilation undercut
- PRIME hinges (apply to dedicated door frames)
- PRIME lock with glossy faceplate (silver or gold)
- magnetic lock
- preparation for shortening (maximum 60 mm)
- reinforcement for door closer (third hinge is required)
- stainless steel porthole
- hook lock with side pull handles (sliding doors)
- oblong pull handle for sliding doors
- caps for standard hinges (set for 1 PCs)
- frosted tempered glass - model M
- frosted tempered glass - model D
- frosted tempered glass - model L
- handle with an escutcheon

(see p. 200)

LONDON, VIENNA



VIENNA B, White



VIENNA P, White



LONDON P



LONDON O



LONDON B



LONDON C



VIENNA P



VIENNA O



VIENNA B



VIENNA C

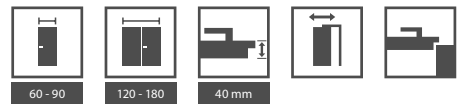

AVAILABLE FINISHES

Standard paint ★★★★★☆



LONDON, VIENNA
wood grains

TECHNICAL INFORMATION

DOOR LEAF CONSTRUCTION

Stabilising infill skinned with embossed HDF.

ACCESSORIES INCLUDED IN THE DOOR LEAF PRICE

- Two or three barrel hinges, PRIME set available ->see extra charges
- Lock: key lock, WC lock, or cylinder lock
- 'Chinchilla' glass
- Round pull handle (for sliding doors)

DOOR FRAMES

Recommended rebated door frames:

- Porta SYSTEM in Portadecor veneer see p. 178
- MINIMAX in Portadecor veneer see p. 176
- STEEL see p. 190-195

NOTES

- Technical Assessment AT-15-6515/2016, ITB Warsaw.
- Double doors are available in any door leaf size combinations.
- We recommend handle and escutcheon, 'Royal' see p.201
- Magnetic lock is not available for a double door.
- Reinforcement for door closer requires third hinge
- Due to various materials use, there might be a slight colour difference between door leaf and a glazing bead/muntin.

EXTRA CHARGES

- ventilation sleeves or ventilation undercut
- preparation for shortening (maximum 60 mm)
- magnetic lock
- PRIME hinges (applies to dedicated door frames)
- PRIME lock with glossy faceplate (silver or gold)
- preparation for shortening (maximum 60 mm)
- reinforcement for door closer (third hinge is required)
- hook lock with side pull handles (sliding doors)
- oblong pull handle for sliding doors
- caps for standard hinges (set for 1 pcs)
- handle with an escutcheon

(see p. 200)

Porta ROYAL Premium



Porta ROYAL Premium A, White



Porta ROYAL Premium A, White



model P



model M



model A

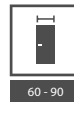

AVAILABLE FINISHES

Premium paint ★★★★★☆



perfectly smooth surface

TECHNICAL INFORMATION

DOOR LEAF CONSTRUCTION

Stabilising infill or chipboard core (extra charge) skinned with embossed HDF.

ACCESSORIES INCLUDED IN THE DOOR LEAF PRICE

- Two or three barrel hinges, PRIME set available - see extra charges
- Lock: key lock, WC lock, or cylinder lock
- Crosted glass
- Round pull handle (for sliding doors)

DOOR FRAMES

Recommended rebated door frames:

- Porta SYSTEM in Premium veneer see p. 178
- MINIMAX in Premium veneer see p. 176
- STEEL see p. 190-195

Recommended non-rebated door frames:

- Porta SYSTEM ELEGANCE finished with Premium veneer see p. 180
- LEVEL finished with Premium veneer see p. 182

NOTES

- Technical Assessment AT-15-6515/2016, ITB Warsaw.
- Double doors are available in any door leaf size combinations.
- We recommend handle and escutcheon, Royal' see p.201
- Magnetic lock is not available for a double door
- Reinforcement for door closer requires third hinge
- Due to various materials use, there might be a slight colour difference between door leaf and a glazing bead

EXTRA CHARGES

- ventilation sleeves or ventilation undercut
- chipboard core
- preparation for shortening (maximum 60 mm)
- magnetic lock
- **OFFER** - PRIME set
- gold 3D hinges (an extra charge added to door frame price)
- third 3D hinge - silver (an extra charge added to door frame price)
- third 3D hinge - gold (an extra charge added to door frame price)
- reinforcement for door closer (third hinge is required)
- hook lock with side pull handles (sliding doors)
- oblong pull handle for sliding doors
- caps for standard hinges (set for 1 PCs)
- handle with an escutcheon

(see p. 200)

Porta SCANDIA Premium



WE RECOMMEND

Simplicity of the Scandinavian style

Porta SCANDIA Premium A.0, White



Porta SCANDIA Premium A.0, White



model A.0



model B.0



model R.0

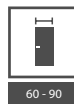

AVAILABLE FINISHES

Premium paint ★★★★★☆

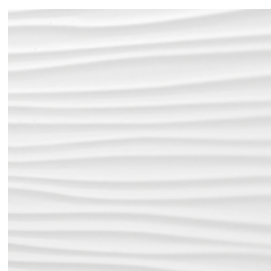

relief, model R.0



perfectly smooth surface
model A.0, B.0

TECHNICAL INFORMATION

DOOR LEAF CONSTRUCTION

Stabilising infill or hollow chipboard core (extra charge) skinned with embossed HDF.

ACCESSORIES INCLUDED IN THE DOOR LEAF PRICE

- Two or three barrel hinges, PRIME set available ->see extra charges
- Lock: key lock, WC lock, or cylinder lock
- Round pull handle (for sliding doors)

DOOR FRAMES

Recommended rebated door frames:

- Porta SYSTEM in Premium veneer see p. 178
- MINIMAX in Premium veneer see p. 176
- STEEL see p. 190-195

Recommended non-rebated door frames:

- Porta SYSTEM ELEGANCE finished with Premium veneer see p. 180
- LEVEL finished with Premium veneer see p. 182

NOTES

- Technical Assessment AT-15-6515/2016, ITB Warsaw.
- Double doors are available in any door leaf size combinations.
- Magnetic lock is not available for a double door
- Reinforcement for door closer requires third hinge

EXTRA CHARGES

- ventilation sleeves or ventilation undercut
- hollow chipboard core (model R.0) or chipboard core (model A.0, B.0)
- preparation for shortening (maximum 60 mm)
- **OFFER** - PRIME set
- gold 3D hinges (an extra charge added to door frame price)
- third 3D hinge - silver (an extra charge added to door frame price)
- third 3D hinge - gold (an extra charge added to door frame price)
- reinforcement for door closer (third hinge is required)
- magnetic lock
- hook lock with side pull handles (sliding doors)
- oblong pull handle for sliding doors
- caps for standard hinges (set for 1 PCs)
- handle with an escutcheon

(see p. 200)

Porta VECTOR, FORM Premium

TOP
COLLECTIONS



Porta VECTOR Premium E, White



PREMIUM
PAINT



HIGH
DURABILITY



Porta VECTOR Premium V, White



VECTOR T



VECTOR A



VECTOR B



VECTOR C



VECTOR E



VECTOR U



VECTOR V



VECTOR W



VECTOR Y



VECTOR Q



FORM 1



FORM 2



FORM 3



FORM 5

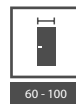

AVAILABLE FINISHES

Premium paint ★★★★★☆



UV acrylic paint ★★★★★☆



NOTE

UV acrylic paint is highly resistant to:
- dirt (coffee, alcohol, grease)
- abrasion
- scratches
- impacts.

**Guarantee of colour permanence for years.
For the door leaf we recommend door
frame in UV acrylic paint.**



Give free rein to your imagination! Do you have your own door concept? You can order any milling with Porta CONTRACT, details regarding bespoke orders, see page 226.



See Porta VECTOR collection:
www.porta.com.pl/dm/portavector.wmv



decorative milling close up

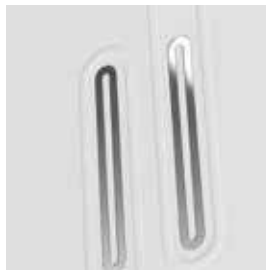

chrome application

NOTE

If you're looking for a glazed door that matches this collection, check Porta FOCUS Premium see p. 20

TECHNICAL INFORMATION

DOOR LEAF CONSTRUCTION

Honeycomb or hollow chipboard core reinforced with rails and stiles (at an extra charge). The construction is skinned with HDF.

ACCESSORIES INCLUDED IN THE DOOR LEAF PRICE

- Two or three barrel hinges, PRIME set available ->see extra charges
- Three hinges for size '100'
- Lock: key lock, WC lock, or cylinder lock
- Round pull handle (for sliding doors)

DOOR FRAMES

Recommended rebated door frames:

- Porta System finished with Premium veneer or UV acrylic paint, see p. 178
- MINIMAX finished with Premium veneer or UV acrylic paint, see p. 176

Recommended non-rebated door frames:

- Porta SYSTEM ELEGANCE finished with Premium veneer or UV acrylic paint see p. 180
- LEVEL finished with Premium veneer or UV acrylic paint see p. 182

NOTES

- Technical Assessment AT-15-6515/2016, ITB Warsaw.
- Double doors are available in any door leaf size combinations.
Passive door leaves (side panels) in sizes '30', '40', '50' available only in flat option (without decorative applications)
- Magnetic lock is not available for a double door
- Reinforcement for door closer requires third hinge

EXTRA CHARGES

- size '100'
- hollow chipboard core
- ventilation sleeves or ventilation undercut
- preparation for shortening (maximum 60 mm)
- **OFFER** - prime set
- gold 3D hinges (an extra charge added to door frame price)
- third 3D hinge - silver (an extra charge added to door frame price)
- third 3D hinge - gold (an extra charge added to door frame price)
- magnetic lock
- reinforcement for door closer (third hinge is required)
- hook lock with side pull handles (sliding doors)
- oblong pull handle for sliding doors
- caps for standard hinges (set for 1 PCs)
- handle with an escutcheon

(see p. 200)

Porta FOCUS Premium

TOP
COLLECTIONS



Porta FOCUS Premium 4.A, White



PREMIUM
PAINT



HIGH
DURABILITY



Porta FOCUS Premium 4.A, White



model 5.A



model 5.B



model 5.C



model 4.A



model 4.B



model 4.C



Porta VECTOR
model E
see page 18



model 4.D



model 4.E



AVAILABLE FINISHES

Premium paint ★★★★★☆



UV acrylic paint ★★★★★☆



NOTE

UV acrylic paint is highly resistant to:

- dirt (coffee, alcohol, grease)
- abrasion
- scratches
- impacts

Guarantee of colour permanence for years.
For the door leaf we recommend door frame in UV acrylic paint.



decorative milling close up
model 4.D



glass-door panel joint

NOTE

If you're looking for a flush door that matches this collection, check Porta VECTOR Premium see p. 18

TECHNICAL INFORMATION

DOOR LEAF CONSTRUCTION

Honeycomb or hollow chipboard core reinforced with rails and stiles (at an extra charge). The construction is skinned with HDF. Glazed models come with 8 mm thick, frosted tempered glass, which is an element of the construction.

ACCESSORIES INCLUDED IN THE DOOR LEAF PRICE

- Two or three barrel hinges, PRIME set available - see extra charges
- Three hinges for size '100'
- Lock: key lock, WC lock, or cylinder lock
- 8 mm thick, frosted, tempered glass
- Round pull handle (for sliding doors)

DOOR FRAMES

Recommended rebated door frames:

- Porta System finished with Premium veneer or UV acrylic paint see p. 178
- MINIMAX finished with Premium veneer or UV acrylic paint see p. 176

Recommended non-rebated door frames:

- Porta SYSTEM ELEGANCE finished with Premium veneer or UV acrylic paint see p. 180
- LEVEL finished with Premium veneer or UV acrylic paint see p. 182

NOTES

- Technical Assessment AT-15-6515/2016, ITB Warsaw.
- Double doors are available in any door leaf size combinations.
- For non-rebated double door, 'active' and 'passive' door leaves must be ordered 4.B, and 4.D models are available only with hollow chipboard core, free of extra charge
- Fixed size of glass, model 4.A
- Magnetic lock is not available for a double door
- Ventilation undercut in glazed models is available only for Polish Norm

EXTRA CHARGES

- size '100'
- hollow chipboard core
- ventilation undercut
- preparation for shortening - group 5 models (maximum 60 mm)
- OFFER - prime set
- gold 3D hinges (an extra charge added to door frame price)
- third 3D hinge - silver (an extra charge added to door frame price)
- third 3D hinge - gold (an extra charge added to door frame price)
- magnetic lock
- hook lock with side pull handles (sliding doors)
- oblong pull handle for sliding doors
- caps for standard hinges (set for 1 PCs)
- handle with an escutcheon

(see p. 200)

Porta DESIRE UV

TOP
COLLECTIONS



Porta DESIRE 2, White

UV
HIGH
DURABILITY



Porta DESIRE 3, White with a black decorative door inlay



model 1



model 2



model 3
black decorative
inlays



model 4
black decorative
inlays



model 3
silver decorative
inlays



model 4
silver decorative
inlays

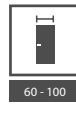

AVAILABLE FINISHES

UV acrylic paint ★★★★★☆



NOTE

UV acrylic paint is highly resistant to:

- dirt (coffee, alcohol, grease)
- abrasion
- scratches
- impacts

**Guarantee of colour permanence for years.
For the door leaf we recommend door
frame in UV acrylic paint.**



decorative milling model 2

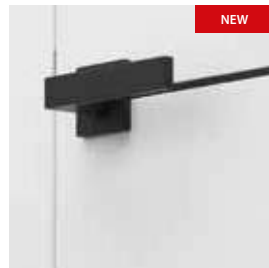

Black decorative inlay, model 3.
Silver decorative inlays are also
available

TECHNICAL INFORMATION

DOOR LEAF CONSTRUCTION

Honeycomb or hollow chipboard core reinforced with glued wood rails and stiles (at an extra charge). The construction is skinned with HDF.

Satin look, smooth surface is achieved thanks to UV painting technology.

Model 3 and 4 with decorative door inlays (inlays colours: silver or black).

ACCESSORIES INCLUDED IN THE DOOR LEAF PRICE

- Three PRIME or barrel hinges
- Lock: key lock, WC lock, or cylinder lock
- Preparation for shortening (maximum 60 mm)

DOOR FRAMES

Recommended rebated door frames:

- Porta System finished with Premium veneer or UV acrylic paint, see p. 178
- MINIMAX finished with Premium veneer or UV acrylic paint, see p. 176

Recommended non-rebated door frames:

- Porta SYSTEM ELEGANCE finished with Premium veneer or UV acrylic paint, see p. 180
- LEVEL finished with Premium veneer or UV acrylic paint, see p. 182

NOTES

- Technical Assessment AT-15-6515/2016, ITB Warsaw.
- Double doors are available in any door leaf size combinations.
- Magnetic lock is not available for a double door '2200' height -available through Contract order, see p. 226
- Rebated door is equipped with 3 PRIME hinges non-rebated with 2 3D hinges - hinges come with a door frame.

EXTRA CHARGES

- size '100'
- ventilation undercut
- preparation for shortening - group 5 models (maximum 60 mm)
- gold 3D hinges (an extra charge added to door frame price)
- third 3D hinge - silver (an extra charge added to door frame price)
- third 3D hinge - gold (an extra charge added to door frame price)
- magnetic lock
- hook lock with side pull handles (sliding doors)
- oblong pull handle for sliding doors
- handle with an escutcheon

(see p. 200)

Porta GRANDE UV

TOP
COLLECTIONS



WE RECOMMEND

Frame and panel construction of Grande collection and new UV painting technology guarantee long-lasting durability.

Porta GRANDE G.4, White

UV
HIGH
DURABILITY



Porta GRANDE G.4, White



model G.0



model G.4



model F.0
model F.0 with decorative
slats made of solid oak



model A.0



model A.1



model A.1
with a mirror



model C.0



model B.0



model B.1



model B.3



model D.0

Check more models
from this collection
on a website



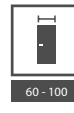

AVAILABLE FINISHES

UV acrylic paint ★★★★★☆



NOTE

UV acrylic paint is highly resistant to:

- dirt (coffee, alcohol, grease)
- abrasion
- scratches
- impacts

**Guarantee of colour permanence for years.
For the door leaf we recommend door frame
in UV acrylic paint.**

AVAILABLE FINISHES OF DECORATIVE SLATS

Solid Oak ★★★★★☆



Natural veneer - Oak ★★★★★☆



Portaperfect 3D veneer ★★★★★☆

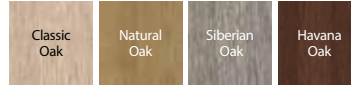

Brushed aluminium



glazing of G.4 model - glass panel recessed in comparison to the surface of a door panel



flush panel



Decorative slat made of solid oak, flush with the surface of door leaf panel, horizontal graining



Model G.0 - decorative slat (Portaperfect finish or Natural Oak) is recessed in comparison to the surface of a door leaf panel. Vertical graining is optional at an extra charge.



Model G.0 - decorative slat (brushed aluminium) is recessed in comparison to the surface of a door leaf panel. Vertical graining is optional at an extra charge.

TECHNICAL INFORMATION

DOOR LEAF CONSTRUCTION

Satin look, smooth surface is achieved thanks to UV painting technology.

It is possible to produce model A.1 with a mirror on one or on both sides. If the mirror is only on one side, there is a solid board on another side.

There is a possibility to choose decorative slats made of solid oak, which are flush with the surface of door leaf panels (model F). Another option are slats in synthetic or natural veneer or brushed aluminium which are recessed in comparison to the surface of door leaf panels (model G).

ACCESSORIES INCLUDED IN THE DOOR LEAF PRICE

- Three PRIME or standard barrel hinges
- Lock with silver or glossy gold plate: key lock, WC lock, or cylinder lock
- Frosted, tempered glass
- Round pull handle (for sliding doors)
- Preparation for shortening (maximum 60 mm)

DOOR FRAMES

Recommended rebated door frames:

- Porta System finished with UV acrylic paint, see p. 178
- MINIMAX finished with UV acrylic paint, see p. 176

Recommended non-rebated door frames:

- Porta SYSTEM ELEGANCE finished with Premium veneer or UV acrylic paint, see p. 180
- LEVEL finished with Premium veneer or UV acrylic paint see, p. 182

NOTES

- Technical Assessment AT-15-6515/2016, ITB Warsaw.
- Double doors are available in any door leaf size combinations.
- A rebated door is equipped with 3 PRIME hinges non-rebated with 2 3D hinges - hinges come with a door frame.
- Magnetic lock is not available for a double door

EXTRA CHARGES

- decorative slat in Portaperfect finish (model G)
- decorative slat - brushed aluminium (model G)
- decorative slat in natural veneer (model G)
- size '100'
- ventilation undercut
- gold 3D hinges (an extra charge added to door frame price)
- third 3D hinge - silver (an extra charge added to door frame price)
- third 3D hinge - gold (an extra charge added to door frame price)
- magnetic lock
- mirror on one side
- mirror on both sides
- hook lock with side pull handles (sliding doors)
- oblong pull handle for sliding doors
- handle with an escutcheon

(see p. 200)

Porta DUO



WE RECOMMEND

Combination of white colour with a vertical panel in natural or ligniform veneer is a timeless and glamorous interior arrangement. It's suitable for homes and public areas, regardless of their style.

Porta DUO 4.0, White UV paint with Natural Oak

UV
HIGH
DURABILITY



Porta DUO 4.0, White UV paint with Natural Oak



model 4.0



model 4.A
with a glass



model 4.0



model 4.A
with a glass panel

AVAILABLE FINISHES

UV acrylic paint ★★★★★☆



NOTE

UV acrylic paint is highly resistant to:
- dirt (coffee, alcohol, grease)
- abrasion
- scratches
- impacts

**Guarantee of colour permanence for years.
For the door leaf we recommend door
frame in UV acrylic paint.**

AVAILABLE FINISHES - PANEL

Portadecor veneer ★★☆☆☆☆



Natural veneer - Oak ★★★★★☆



Portaperfect 3D veneer ★★★★★☆



Natural Satin Oak Veneer ★★★★★☆



Natural Select Veneer ★★★★★☆



glass-panel joint



panels joint

TECHNICAL INFORMATION

DOOR LEAF CONSTRUCTION

The door leaf consists of: a wide, painted panel and a narrow stile covered with natural or synthetic veneer. For a glazed model we use 8 mm thick, frosted, tempered glass which is a construction element of the door leaf. Painted white part has a satin smooth surface which is achieved thanks to UV painting technology. Natural veneer is protected with ecological water varnishes, hardened under UV lamp (semi-matt effect).

ACCESSORIES INCLUDED IN THE DOOR LEAF PRICE

- Two hidden hinges 3D, 3 hinges at an extra charge
- Lock with silver or glossy gold faceplate: key lock, WC lock, or cylinder lock
- Preparation for shortening, model 4.0 maximum 60 mm
- 8 mm, frosted, tempered glass

DOOR FRAMES

- Porta SYSTEM ELEGANCE finished with Premium veneer or UV acrylic paint see p. 180
- LEVEL finished with Premium veneer or UV acrylic paint see p. 182

NOTES

- Technical Assessment AT-15-6515/2016, ITB Warsaw.
- Double doors are available in any door leaf size combinations.
- For a double door, 'active' and 'passive' door leaves must be ordered
- Magnetic lock is not available for a double door
- Size '100' is equipped with 3 hinges
- Fixed size of glass, model 4.A
- Ventilation undercut in glazed models is available only for Polish Norm

EXTRA CHARGES

- size '100'
- ventilation undercut
- gold 3D hinges (an extra charge added to door frame price)
- third 3D hinge - silver (an extra charge added to door frame price)
- third 3D hinge - gold (an extra charge added to door frame price)
- magnetic lock
- handle with an escutcheon

(see p. 200)

Porta HIDE



Porta HIDE, 1.1

WE RECOMMEND

Porta HIDE opens up new possibilities for interior designs. It allows you to install the door leaf and frame within the wall to be then decorated in the same finish as the wall (eg. paint, wallpaper) to create a hidden door.



PREMIUM
PAINT



Porta HIDE, 1.1, White



model 1.1



model A



model B

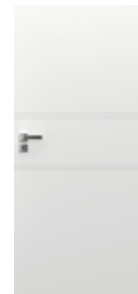

model C

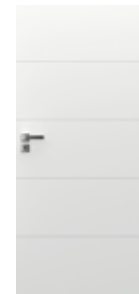

model E



model U



model V



model W



model Y



model Q



PREMIUM PAINT

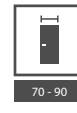

70 - 90



40mm



AVAILABLE FINISHES

Premium paint ★★★★★☆



Primer paint for self painting and wallpapering



decorative milling close up



Non-rebated door leaf (outwards) - right door



Reversed rebate (opening inwards) - left door

TECHNICAL INFORMATION

DOOR LEAF CONSTRUCTION

Non-rebated door leaf (opening outwards) or door leaf with reversed rebate (opening inwards). A honeycomb or hollow core (at an extra charge) reinforced with rails and stiles. The construction is skinned with HDF.

Available two types of finish:

- Prime finish ready for painting or wallpapering
- White Premium Paint finish

DOOR FRAMES

Hidden aluminium door frame, ready for painting with wall paint. It's dedicated for 40 mm thick, wooden door leaves.

Can be assembled on concrete wall or plasterboard wall.

Dimensions see page 212, Table 6.

DOORS INCLUDE

- Door leaf
- Two 3D hinges
- Three 3D hinges for hollow core
- Magnetic lock: key lock, WC lock or cylinder lock
- Hidden aluminium door frame

NOTES

- Technical Assessment AT-15-6515/2016, ITB Warsaw. - door leaf
- Technical Assessment ITB-KOT-2019/1076 edition 1- door frame
- Dedicated 3D hinge

EXTRA CHARGES

- ventilation undercut
- automatic threshold seal
- hollow core
- handle with an escutcheon

(see p. 200)

02

FRAME AND PANEL INTERIOR DOORS SYNTHETIC VENEER

The most distinctive feature of frame and panel doors is the multilayered construction. They are an option for customers who appreciate the highest quality.



**SOME PEOPLE SAY THAT I NIGGLE OVER DETAILS,
BUT I'M JUST ACCURATE.**
THAT'S WHY I HAVE CHOSEN FRAME AND PANEL
DOORS - THEIR FINISHING IS EXCELLENT!



Porta Verte HOME, group A and B



Porta Verte HOME B.5, Wenge White



Porta Verte HOME B.0, Wenge White



model A.0



model A.2



model A.6



model A.8



model B.1



model B.2



model B.5



model B.6

Check more models from this collection on a website



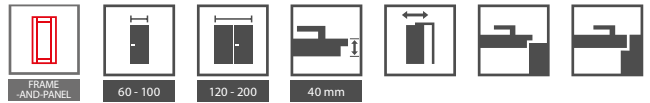

AVAILABLE FINISHES

Portadecor veneer ★★★★★☆



Portaperfect 3D veneer ★★★★★☆

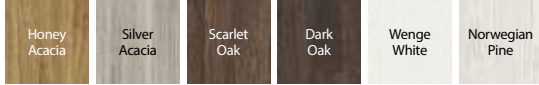

Premium veneer ★★★★★☆



Portaperfect 3D veneer ★★★★★☆



Portalamino ★★★★★☆

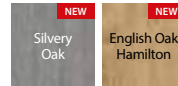

model B.0 - slim panel



model B.5 - dedicated frosted glass panel with transparent stripes



model A.0 - slim panel

TECHNICAL INFORMATION

DOOR LEAF CONSTRUCTION

Door leaves contain rails, slim panels and 4 mm thick, frosted, tempered glass. Combination of those depends on a model.

ACCESSORIES INCLUDED IN THE DOOR LEAF PRICE

- Lock key lock, WC lock, cylinder lock, handle only
- 3 barrel hinges or PRIME hinges (see extra charges)
- Frosted tempered glass
- Preparation for shortening (maximum 30 mm)
- Round pull handle (for sliding doors)

DOOR FRAMES

Recommended rebated door frames:

- Porta SYSTEM see p. 178
- MINIMAX see p. 176
- STEEL see p. 190-195

Recommended non-rebated door frames:

- Porta SYSTEM ELEGANCE see p. 180
- LEVEL see p. 182

NOTES

- Technical Assessment AT-15-6515/2016, ITB Warsaw.
- Double doors are available in any door leaf size combinations. For a non-rebated double door, 'active' and 'passive' door leaves must be ordered
- Magnetic lock is not available for a double door

EXTRA CHARGES

- size '100'
- ventilation undercut or ventilation sleeves
- PRIME hinges (for dedicated door frames)
- PRIME lock with glossy faceplate (silver or gold)
- gold 3D hinges (an extra charge added to a door frame price)
- third 3D hinge - silver (an extra charge added to a door frame price)
- third 3D hinge - gold (an extra charge added to a door frame price)
- magnetic lock
- hook lock with side pull handles (sliding doors)
- oblong pull handle for sliding doors
- caps for standard hinges (set for 1 PCs)
- handle with an escutcheon

(see p. 200)

Porta Verte HOME, group C

TOP
COLLECTIONS



Porta Verte HOME C.5, Scarlet Oak



Porta Verte HOME C.5, Scarlet Oak



model C.0



model C.1



model C.2



model C.3



model C.4



model C.5



model C.0 decorative inlays



model C.5 decorative inlays

Check more models
from this collection
on a website



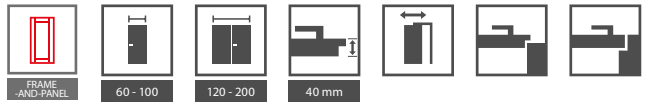

AVAILABLE FINISHES

Portadecor veneer ★★★★★☆



Portaperfect 3D veneer ★★★★★☆



Premium veneer ★★★★★☆



Portaperfect 3D veneer ★★★★★☆

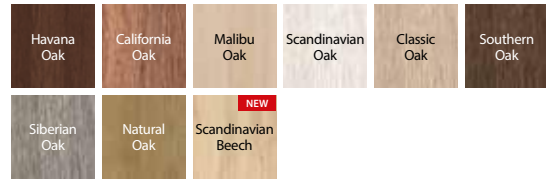

Portalamino ★★★★★☆

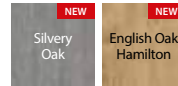

decorative inlays
- aluminium colour



frosted tempered glass

TECHNICAL INFORMATION

DOOR LEAF CONSTRUCTION

Door leaves contain rails, slim panels and 4 mm thick, frosted, tempered glass. Combination of those depends on a model.

ACCESSORIES INCLUDED IN THE DOOR LEAF PRICE

- Lock: key lock, WC lock, cylinder lock, handle only
- 3 barrel hinges or PRIME hinges (see extra charges)
- Frosted tempered glass
- Preparation for shortening (maximum 30 mm)
- Round pull handle (for sliding doors)

DOOR FRAMES

Recommended rebated door frames:

- Porta SYSTEM see p. 178
- MINIMAX see p. 176
- STEEL see p. 190-195

Recommended non-rebated door frames:

- Porta SYSTEM ELEGANCE see p. 180
- LEVEL see p. 182

NOTES

- Technical Assessment AT-15-6515/2016, ITB Warsaw.
- Double doors are available in any door leaf size combinations. For a double non-rebated door, 'active' and 'passive' door leaves must be ordered.
- Magnetic lock is not available for a double door.

EXTRA CHARGES

- size '100'
- ventilation undercut or ventilation sleeves
- PRIME hinges (for dedicated door frames)
- PRIME lock with glossy faceplate (silver or gold)
- gold 3D hinges (an extra charge added to a door frame price)
- third 3D hinge - silver (an extra charge added to a door frame price)
- third 3D hinge - gold (an extra charge added to a door frame price)
- magnetic lock
- hook lock with side pull handles (sliding doors)
- oblong pull handle for sliding doors
- caps for standard hinges (set for 1 PCs)
- handle with an escutcheon

(see p. 200)

Porta Verte HOME, group D

TOP
COLLECTIONS



Porta Verte HOME D.7, Scandinavian Oak



Porta Verte HOME D.7, Scandinavian Oak



model D.0



model D.1



model D.2



model D.3



model D.4



model D.5



model D.6



model D.7



model D.0
decorative inlays



model D.7
decorative inlays

Check more models
from this collection
on a website



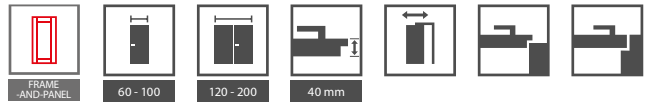

AVAILABLE FINISHES

Portadecor veneer ★★★★★☆



Portaperfect 3D veneer ★★★★★☆



Premium veneer ★★★★★☆



Portaperfect 3D veneer ★★★★★☆

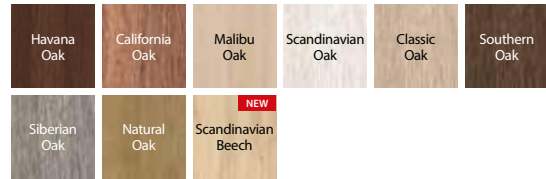

Portalamino ★★★★★☆

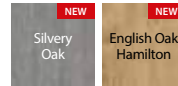

decorative inlays
- aluminium colour

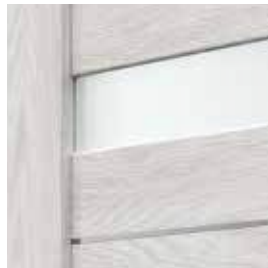

frosted tempered glass panel

TECHNICAL INFORMATION

DOOR LEAF CONSTRUCTION

Door leaves contain rails, slim panels and 4 mm thick, frosted, tempered glass. Combination of those depends on a model.

ACCESSORIES INCLUDED IN THE DOOR LEAF PRICE

- Lock key lock, WC lock, cylinder lock, handle only
- 3 barrel hinges or PRIME hinges (see extra charges)
- Frosted tempered glass
- Preparation for shortening (maximum 30 mm)
- Round pull handle (for sliding doors)

DOOR FRAMES

Recommended rebated door frames:

- Porta SYSTEM see p. 178
- MINIMAX see p. 176
- STEEL see p. 190-195

Recommended non-rebated door frames:

- Porta SYSTEM ELEGANCE see p. 180
- LEVEL see p. 182

NOTES

- Technical Assessment AT-15-6515/2016, ITB Warsaw.
- Double doors are available in any door leaf size combinations.
For a double non-rebated door, 'active' and 'passive' door leaves must be ordered.
- Magnetic lock is not available for a double door.

EXTRA CHARGES

- size '100'
- ventilation undercut or ventilation sleeves
- PRIME hinges (for dedicated door frames)
- PRIME lock with glossy faceplate (silver or gold)
- gold 3D hinges (an extra charge added to a door frame price)
- third 3D hinge - silver (an extra charge added to a door frame price)
- third 3D hinge - gold (an extra charge added to a door frame price)
- magnetic lock
- hook lock with side pull handles (sliding doors)
- oblong pull handle for sliding doors
- caps for standard hinges (set for 1 pcs)
- handle with an escutcheon

(see p. 200)

Porta Verte HOME, group E and F



Porta Verte HOME E.0 i E.0 with a blackboard, Norwegian Pine



Porta Verte HOME E.0, Norwegian Pine



model E.0



model E.1



model E.5



model E.0
blackboard



model F.5

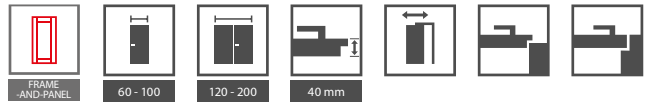

AVAILABLE FINISHES

Portadecor veneer ★★★★★☆



Portaperfect 3D veneer ★★★★★☆



Portaperfect 3D veneer ★★★★★☆

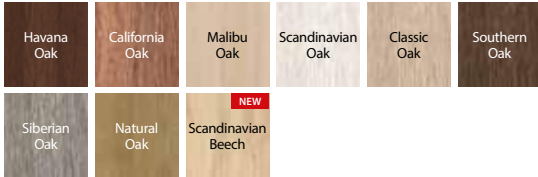

an option with a magnetic blackboard for drawing with chalk markers (this option is available for E.0 model for one side, rebated version only)



glazing, model E.5

TECHNICAL INFORMATION

DOOR LEAF CONSTRUCTION

Door leaves contain rails, slim panels and 4 mm thick, frosted, tempered glass. Combination of those depends on a model.

ACCESSORIES INCLUDED IN THE DOOR LEAF PRICE

- Lock: key lock, WC lock, cylinder lock, handle only
- 3 barrel hinges or PRIME hinges (see extra charges)
- Frosted tempered glass
- Preparation for shortening (maximum 30 mm)
- Round pull handle (for sliding doors)

DOOR FRAMES

Recommended rebated door frames:

- Porta SYSTEM see p. 178
- MINIMAX see p. 176
- STEEL see p. 190-195

Recommended non-rebated door frames:

- Porta SYSTEM ELEGANCE see p. 180
- LEVEL see p. 182

NOTES

- Technical Assessment AT-15-6515/2016, ITB Warsaw.
- Double doors are available in any door leaf size combinations. For a double non-rebated door, 'active' and 'passive' door leaves must be ordered
- Magnetic lock is not available for a double door

EXTRA CHARGES

- size '100'
- ventilation undercut or ventilation sleeves
- PRIME hinges (for dedicated door frames)
- RIME lock with glossy faceplate (silver or gold)
- gold 3D hinges (an extra charge added to a door frame price)
- third 3D hinge - silver (an extra charge added to a door frame price)
- third 3D hinge - gold (an extra charge added to a door frame price)
- magnetic lock
- hook lock with side pull handles (sliding doors)
- oblong pull handle for sliding doors
- caps for standard hinges (set for 1 PCs)
- handle with an escutcheon

(see p. 200)

Porta Verte HOME, group G

TOP
COLLECTIONS



Porta Verte HOME G.4, Portadecor veneer, White



Porta Verte HOME G.4, White



model G.0



model G.1



model G.2



model G.3



model G.4



model G.0
decorative inlays



model G.4
decorative inlays

Check more models
from this collection
on a website



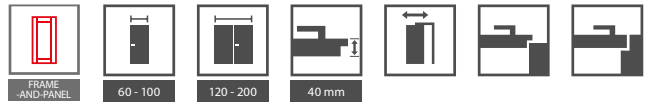

AVAILABLE FINISHES

Portadecor veneer ★★★★★☆

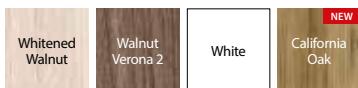

Portaperfect 3D veneer ★★★★★☆

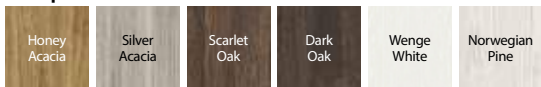

Portaperfect 3D veneer ★★★★★☆

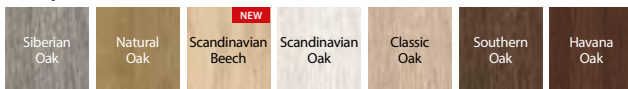

AVAILABLE FINISHES OF DECORATIVE SLATS

Portaperfect 3D veneer ★★★★★☆

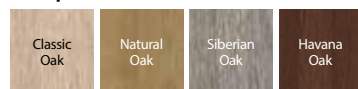

Brushed aluminium



glazing, model G.4



decorative inlays
- aluminium colour

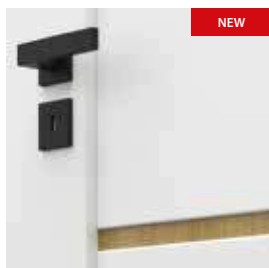

Model G.0 - decorative slat (Portaperfect finish) is recessed in comparison to the surface of a door leaf panel. Vertical graining is optional at an extra charge.

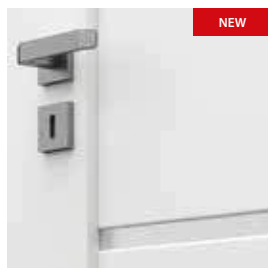

Model G.0 - decorative slat (brushed aluminium) is recessed in comparison to the surface of a door leaf panel. Vertical graining is optional at an extra charge.

TECHNICAL INFORMATION

DOOR LEAF CONSTRUCTION

Door leaves contain rails, slim panels and 4 mm thick, frosted, tempered glass. Combination of those depends on a model. For models in white finishes you can choose decorative slats in two options: Portaperfect veneer or brushed aluminium (at an extra charge).

ACCESSORIES INCLUDED IN THE DOOR LEAF PRICE

- Lock: key lock, WC lock, cylinder lock, handle only
- 3 barrel hinges or PRIME hinges (see extra charges)
- Frosted tempered glass
- Preparation for shortening (maximum 30 mm)
- Round pull handle (for sliding doors)

DOOR FRAMES

Recommended rebated door frames:

- Porta SYSTEM see p. 178
- MINIMAX see p. 176
- STEEL see p. 190-195

Recommended non-rebated door frames:

- Porta SYSTEM ELEGANCE see p. 180
- LEVEL see p. 182

NOTES

- Technical Assessment AT-15-6515/2016, ITB Warsaw.
- Double doors are available in any door leaf size combinations. For a double non-rebated door, 'active' and 'passive' door leaves must be ordered.
- Magnetic lock is not available for a double door.

EXTRA CHARGES

- decorative slat Portaperfect finish (white door leaf)
- decorative slat, brushed aluminium (white door leaf)
- size "100"
- ventilation undercut or ventilation sleeves
- PRIME hinges (for dedicated door frames)
- PRIME lock with glossy faceplate (silver or gold)
- gold 3D hinges (an extra charge added to a door frame price)
- third 3D hinge - silver (an extra charge added to a door frame price)
- third 3D hinge - gold (an extra charge added to a door frame price)
- magnetic lock
- hook lock with side pull handles (sliding doors)
- oblong pull handle for sliding doors
- caps for standard hinges (set for 1 PCs)
- handle with an escutcheon

(see p. 200)

Porta Verte HOME, group H

TOP
COLLECTIONS



Porta Verte HOME H.5, Natural Oak



Porta Verte HOME H.5, Natural Oak



model H.0



model H.1



model H.2



model H.3



model H.4



model H.5

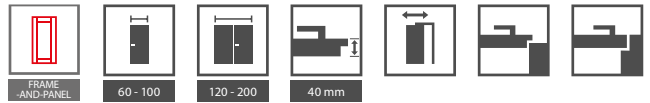

AVAILABLE FINISHES

Portadecor veneer ★★★★★☆



Portaperfect 3D veneer ★★★★★☆



Portaperfect 3D veneer ★★★★★☆

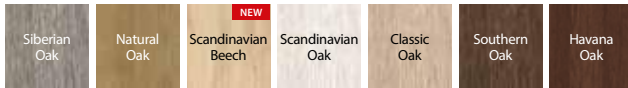

AVAILABLE FINISHES OF DECORATIVE SLATS

Portaperfect 3D veneer ★★★★★☆

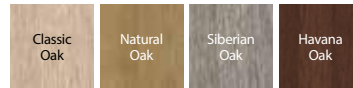

Brushed aluminium



model H.0 - slim panel



model H.5 - glazing

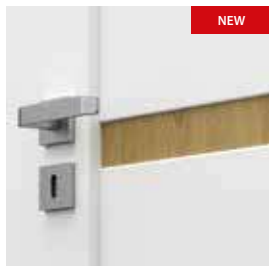

Model H.0 - decorative slat (Portaperfect finish) is recessed in comparison to the surface of a door leaf panel. Vertical graining is optional at an extra charge.

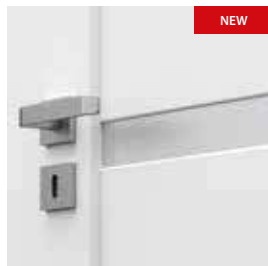

Model H.0 - decorative slat (brushed aluminium) is recessed in comparison to the surface of a door leaf panel. Vertical graining is optional at an extra charge.

TECHNICAL INFORMATION

DOOR LEAF CONSTRUCTION

Door leaves contain rails, slim panels and 4 mm thick, frosted, tempered glass. Combination of those depends on a model. For models in white finishes you can choose decorative slats in two options: Portaperfect veneer or brushed aluminium (at an extra charge).

ACCESSORIES INCLUDED IN THE DOOR LEAF PRICE

- Lock: key lock, WC lock, cylinder lock, handle only
- 3 barrel hinges or PRIME hinges (see extra charges)
- Frosted tempered glass
- Preparation for shortening (maximum 30 mm)
- Round pull handle (for sliding doors)

DOOR FRAMES

Recommended rebated door frames:

- Porta SYSTEM see p. 178
- MINIMAX see p. 176
- STEEL see p. 190-195

Recommended non-rebated door frames:

- Porta SYSTEM ELEGANCE see p. 180
- LEVEL see p. 182

NOTES

- Technical Assessment AT-15-6515/2016, ITB Warsaw.
- Double doors are available in any door leaf size combinations. For a double non-rebated door, 'active' and 'passive' door leaves must be ordered
- Magnetic lock is not available for a double door

EXTRA CHARGES

- decorative slat Portaperfect finish (white door leaf)
- decorative slat, brushed aluminium (white door leaf)
- size '100'
- ventilation undercut or ventilation sleeves
- PRIME hinges (for dedicated door frames)
- PRIME lock with glossy faceplate (silver or gold)
- gold 3D hinges (an extra charge added to a door frame price)
- third 3D hinge - silver (an extra charge added to a door frame price)
- third 3D hinge - gold (an extra charge added to a door frame price)
- magnetic lock
- hook lock with side pull handles (sliding doors)
- oblong pull handle for sliding doors
- caps for standard hinges (set for 1 PCS)
- handle with an escutcheon

(see p. 200)

Porta Verte HOME, group J



Porta Verte HOME J.6, White



Porta Verte HOME J.6, White



model J.0



model J.1



model J.2



model J.4



model J.5



model J.6

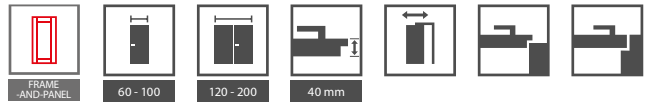

AVAILABLE FINISHES

Portadecor veneer ★★★★★☆



Portaperfect 3D veneer ★★★★★☆



Portaperfect 3D veneer ★★★★★☆

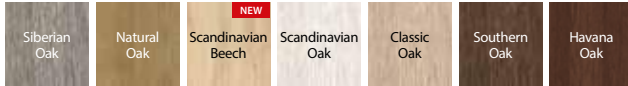

AVAILABLE FINISHES OF DECORATIVE SLATS

Portaperfect 3D veneer ★★★★★☆

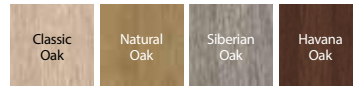

Brushed aluminium



model J.6 - slim panel



model J.6 - glazing



Model J.0 - decorative slat (Portaperfect finish) is recessed in comparison to the surface of a door leaf panel. Vertical graining is optional at an extra charge.



Model J.0 - decorative slat (brushed aluminium) is recessed in comparison to the surface of a door leaf panel. Vertical graining is optional at an extra charge.

TECHNICAL INFORMATION

DOOR LEAF CONSTRUCTION

Door leaves contain rails, slim panels and 4 mm thick, frosted, tempered glass. Combination of those depends on a model. For models in white finishes you can choose decorative slats in two options: Portaperfect veneer or brushed aluminium (at an extra charge).

ACCESSORIES INCLUDED IN THE DOOR LEAF PRICE

- Lock: key lock, WC lock, cylinder lock, handle only
- 3 barrel hinges or PRIME hinges (see extra charges)
- Frosted tempered glass
- Preparation for shortening (maximum 30 mm)
- Round pull handle (for sliding doors)

DOOR FRAMES

Recommended rebated door frames:

- Porta SYSTEM see p. 178
- MINIMAX see p. 176
- STEEL see p. 190-195

Recommended non-rebated door frames:

- Porta SYSTEM ELEGANCE see p. 180
- LEVEL see p. 182

NOTES

- Technical Assessment AT-15-6515/2016, ITB Warsaw.
- Double doors are available in any door leaf size combinations. For a double non-rebated door, 'active' and 'passive' door leaves must be ordered.
- Magnetic lock is not available for a double door.

EXTRA CHARGES

- decorative slat Portaperfect finish (white door leaf)
- decorative slat, brushed aluminium (white door leaf)
- size '1100'
- ventilation undercut or ventilation sleeves
- PRIME hinges (for dedicated door frames)
- PRIME lock with glossy faceplate (silver or gold)
- gold 3D hinges (an extra charge added to a door frame price)
- third 3D hinge - silver (an extra charge added to a door frame price)
- third 3D hinge - gold (an extra charge added to a door frame price)
- magnetic lock
- hook lock with side pull handles (sliding doors)
- oblong pull handle for sliding doors
- caps for standard hinges (set for 1 PCs)
- handle with an escutcheon

(see p. 200)

Porta Verte HOME, group L and N



Porta Verte HOME N.3, Silver Acacia



Porta Verte HOME L.4, Silver acacia



model L.0



model L.1



model L.2



model L.3



model N.0



model N.1



model N.2



model N.3

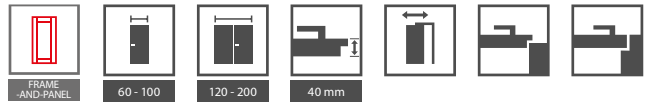

AVAILABLE FINISHES

Portadecor veneer ★★★★★☆



Portaperfect 3D veneer ★★★★★☆



Portaperfect 3D veneer ★★★★★☆



model L.0 - slim panel



model L.4 - glazing



model N.0 - slim panel

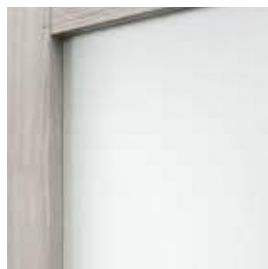

model N.3 - slim panel

TECHNICAL INFORMATION

DOOR LEAF CONSTRUCTION

Door leaves contain rails, slim panels and 4 mm thick, frosted, tempered glass. Combination of those depends on a model.

ACCESSORIES INCLUDED IN THE DOOR LEAF PRICE

- Lock: key lock, WC lock, cylinder lock, handle only
- 3 barrel hinges or PRIME hinges (see extra charges)
- Frosted tempered glass
- Preparation for shortening (maximum 30 mm)
- Round pull handle (for sliding doors)

DOOR FRAMES

Recommended rebated door frames:

- Porta SYSTEM see p. 178
- MINIMAX see p. 176
- STEEL see p. 192-195

Recommended non-rebated door frames:

- Porta SYSTEM ELEGANCE see p. 180
- LEVEL see p. 182

NOTES

- Technical Assessment AT-15-6515/2016, ITB Warsaw.
- Double doors are available in any door leaf size combinations. For a double non-rebated door, 'active' and 'passive' door leaves must be ordered.
- Magnetic lock is not available for a double door.

EXTRA CHARGES

- size '100'
- ventilation undercut or ventilation sleeves
- PRIME hinges (for dedicated door frames)
- PRIME lock with glossy faceplate (silver or gold)
- gold 3D hinges (an extra charge added to a door frame price)
- third 3D hinge - silver (an extra charge added to a door frame price)
- third 3D hinge - gold (an extra charge added to a door frame price)
- magnetic lock
- hook lock with side pull handles (sliding doors)
- oblong pull handle for sliding doors
- caps for standard hinges (set for 1 PC)
- handle with an escutcheon

(see p. 200)

Porta Verte PREMIUM, group A and D

TOP
COLLECTIONS



Porta Verte PREMIUM A.4, Scarlet Oak



Porta Verte PREMIUM A.4, Scarlet Oak



model A.0



model A.1



model A.2



model A.3



model A.4



model D.0



model D.1



model D.2



model D.3



model D.5



model D.6



model D.7



model D.8

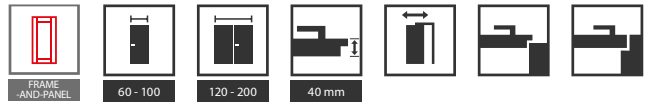

AVAILABLE FINISHES

Portaperfect 3D veneer ★★★★★☆



Portalamino ★★★★★☆

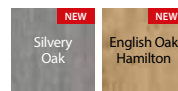

Premium veneer ★★★★★☆



Portaperfect 3D veneer ★★★★★☆



model A.0 - flat panel



model A.0 - frosted glass panel



model D.0 - flat panel



model D.8 - frosted glass panel

TECHNICAL INFORMATION

DOOR LEAF CONSTRUCTION

Door leaves contain rails, slim panels and 6 mm thick, frosted, tempered glass. Combination of those depends on a model.

ACCESSORIES INCLUDED IN THE DOOR LEAF PRICE

- Lock: key lock, WC lock, cylinder lock
- 3 barrel hinges or PRIME set available (see extra charges)
- Frosted tempered glass
- Preparation for shortening (maximum 60 mm)
- Round pull handle (for sliding doors)

DOOR FRAMES

Recommended rebated door frames:

- Porta SYSTEM see p. 178
- MINIMAX see p. 176
- STEEL see p. 190-195

Recommended non-rebated door frames:

- Porta SYSTEM ELEGANCE see p. 180
- LEVEL see p. 182

NOTES

- Technical Assessment AT-15-6515/2016, ITB Warsaw.
- Double doors are available in any door leaf size combinations. For a double non-rebated door, 'active' and 'passive' door leaves must be ordered.
- Magnetic lock is not available for a double door.

EXTRA CHARGES

- size '100'
- ventilation undercut or ventilation sleeves
- **OFFER** - PRIME set
- gold 3D hinges (an extra charge added to a door frame price)
- third 3D hinge - silver (an extra charge added to a door frame price)
- third 3D hinge - gold (an extra charge added to a door frame price)
- magnetic lock
- hook lock with side pull handles (sliding doors)
- oblong pull handle for sliding doors
- caps for standard hinges (set for 1 PCs)
- handle with an escutcheon

(see p. 200)

Porta Verte PREMIUM, group B and C

TOP
COLLECTIONS



Porta Verte PREMIUM C.0, Scandinavian Oak



Porta Verte PREMIUM C.0, Scandinavian Oak



model B.0



model B.1



model B.2



model B.3



model C.0



model C.1



model C.2

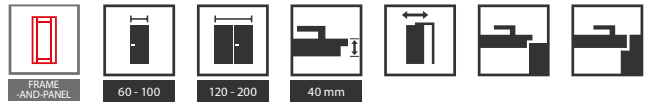

AVAILABLE FINISHES

Portaperfect 3D veneer ★★★★★☆



Portaperfect 3D veneer ★★★★★☆

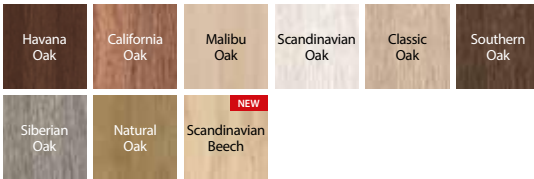

Portalamino ★★★★★☆

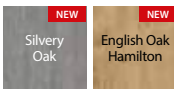

flat panel



frosted glass panel

TECHNICAL INFORMATION

DOOR LEAF CONSTRUCTION

Door leaves contain rails, slim panels and 6 mm thick, frosted, tempered glass. Combination of those depends on a model.

ACCESSORIES INCLUDED IN THE DOOR LEAF PRICE

- Lock: key lock, WC lock, cylinder lock
- 3 barrel hinges or PRIME set available (see extra charges)
- Frosted tempered glass
- Preparation for shortening (maximum 60 mm)
- Round pull handle (for sliding doors)

DOOR FRAMES

Recommended rebated door frames:

- Porta SYSTEM see p. 178
- MINIMAX see p. 176
- STEEL see p. 190-195

Recommended non-rebated door frames:

- Porta SYSTEM ELEGANCE see p. 180
- LEVEL see p. 182

NOTES

- Technical Assessment AT-15-6515/2016, ITB Warsaw.
- Double doors are available in any door leaf size combinations.
For a double non-rebated door, 'active' and 'passive' door leaves must be ordered.
- Magnetic lock is not available for a double door.

EXTRA CHARGES

- size '100'
- ventilation undercut or ventilation sleeves
- **OFFER** - PRIME set
- gold 3D hinges (an extra charge added to a door frame price)
- third 3D hinge - silver (an extra charge added to a door frame price)
- third 3D hinge - gold (an extra charge added to a door frame price)
- magnetic lock
- hook lock with side pull handles (sliding doors)
- oblong pull handle for sliding doors
- caps for standard hinges (set for 1 PCs)
- handle with an escutcheon

(see p. 200)

Porta Verte PREMIUM, group E

TOP
COLLECTIONS



Porta Verte PREMIUM E.5, White



Porta Verte PREMIUM E.5, White



model E.0



model E.1



model E.2



model E.3



model E.4



model E.5

WE RECOMMEND!

EUPHORIA black handle Q with an escutcheon for 0,01 PLN
- only with Porta Verte PREMIUM group E



EUPHORIA Q handle

+



standard profile
escutcheon

or



euro profile
escutcheon

or



WC escutcheon

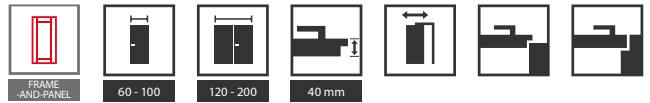

AVAILABLE FINISHES

Portadecor veneer ★★★★★☆



Portaperfect 3D veneer ★★★★★☆

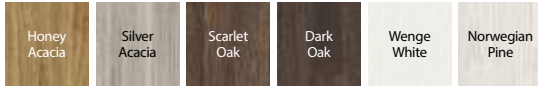

Premium veneer ★★★★★☆



Portaperfect 3D veneer ★★★★★☆

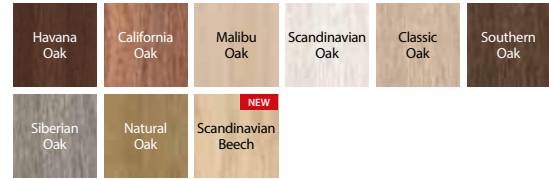

Portalamino ★★★★★☆

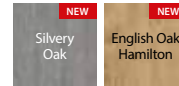

flat panel



frosted glass panel

TECHNICAL INFORMATION

DOOR LEAF CONSTRUCTION

Door leaves contain rails, slim panels and 6 mm thick, frosted, tempered glass. Combination of those depends on a model.

ACCESSORIES INCLUDED IN THE DOOR LEAF PRICE

- Lock: key lock, WC lock, cylinder lock
- 3 barrel hinges or PRIME set available (see extra charges)
- Frosted tempered glass
- Preparation for shortening (maximum 60 mm)
- Round pull handle (for sliding doors)

DOOR FRAMES

Recommended rebated door frames:

- Porta SYSTEM see p. 178
- MINIMAX see p. 176
- STEEL see p. 190-195

Recommended non-rebated door frames:

- Porta SYSTEM ELEGANCE see p. 180
- LEVEL see p. 182

NOTES

- Technical Assessment AT-15-6515/2016, ITB Warsaw.
- Double doors are available in any door leaf size combinations. For a double non-rebated door, 'active' and 'passive' door leaves must be ordered
- Magnetic lock is not available for a double door

EXTRA CHARGES

- size '100'
- ventilation undercut or ventilation sleeves
- **OFFER** - PRIME set
- gold 3D hinges (an extra charge added to a door frame price)
- third 3D hinge - silver (an extra charge added to a door frame price)
- third 3D hinge - gold (an extra charge added to a door frame price)
- magnetic lock
- hook lock with side pull handles (sliding doors)
- oblong pull handle for sliding doors
- caps for standard hinges (set for 1 PCs)
- handle with an escutcheon

(see p. 200)

Porta CONCEPT, group A and B

TOP
COLLECTIONS



WE RECOMMEND

Traditional frame and panel construction guarantees long-time durability.

Porta CONCEPT A.9, Natural Oak



Porta CONCEPT A.9, Natural Oak



model A.0



model A.2



model A.3



model A.4



model A.6



model A.7



model A.8



model A.9



model B.0



model B.1

Check more models
from this collection
on a website



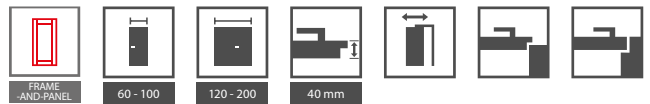

AVAILABLE FINISHES

Portadecor veneer ★★★★★☆

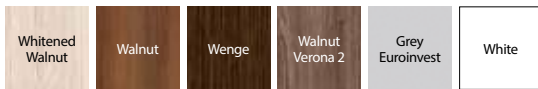

Portaperfect 3D veneer ★★★★★☆



Premium veneer ★★★★★☆



Portadur veneer ★★★★★☆

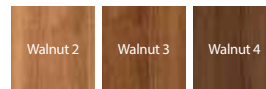

Portaperfect 3D veneer ★★★★★☆

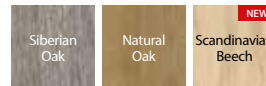

Portalamino ★★★★★☆

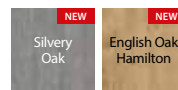

frosted glass panel



flat panel

WE RECOMMEND!

Special, multilayer wooden construction.



TECHNICAL INFORMATION

DOOR LEAF CONSTRUCTION

Door leaves contain rails, slim panels and 6 mm thick, frosted, tempered glass. Combination of those depends on a model.

ACCESSORIES INCLUDED IN THE DOOR LEAF PRICE

- Lock: key lock, WC lock, cylinder lock
- 3 barrel hinges or PRIME set available (see extra charges)
- Frosted tempered glass
- Preparation for shortening (maximum 60 mm)
- Round pull handle (for sliding doors)

DOOR FRAMES

Recommended rebated door frames:

- Porta SYSTEM see p. 178
- MINIMAX see p. 176
- STEEL see p. 190-195

Recommended non-rebated door frames:

- Porta SYSTEM ELEGANCE see p. 180
- LEVEL see p. 182

NOTES

- Technical Assessment AT-15-6515/2016, ITB Warsaw.
- Double doors are available in any door leaf size combinations.
- For a double non-rebated door, 'active' and 'passive' door leaves must be ordered.
- Magnetic lock is not available for a double door.

EXTRA CHARGES

- size '100'
- ventilation undercut or ventilation sleeves
- PRIME hinges (for dedicated door frames)
- PRIME lock with glossy faceplate (silver or gold)
- gold 3D hinges (an extra charge added to a door frame price)
- third 3D hinge - silver (an extra charge added to a door frame price)
- third 3D hinge - gold (an extra charge added to a door frame price)
- magnetic lock
- hook lock with side pull handles (sliding doors)
- oblong pull handle for sliding doors
- caps for standard hinges (set for 1 PCs)
- handle with an escutcheon

(see p. 200)

Porta CONCEPT, group C

TOP
COLLECTIONS



WE RECOMMEND

Traditional frame and panel construction guarantees long-time durability.

Porta CONCEPT C.6, White



Porta CONCEPT C.6, White



model C.0



model C.1



model C.2



model C.3



model C.4



model C.5



model C.6

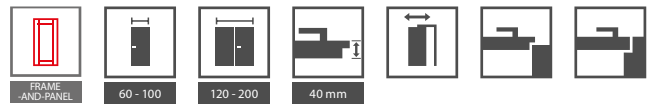

AVAILABLE FINISHES

Portadecor veneer ★★★★★☆

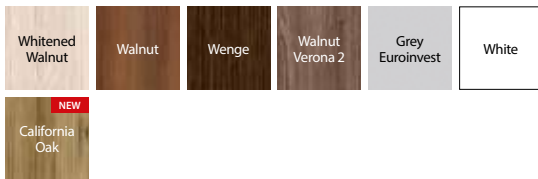

Portaperfect 3D veneer ★★★★★☆



Premium veneer ★★★★★☆



Portadur veneer ★★★★★☆

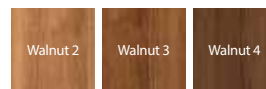

Portaperfect 3D veneer ★★★★★☆

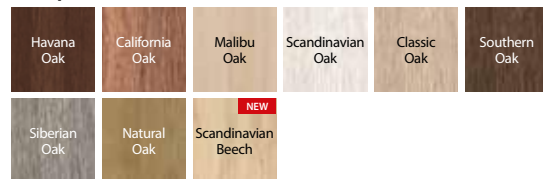

Portalamino ★★★★★☆

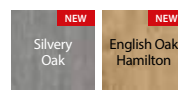

frosted glass panel



flat panel

WE RECOMMEND!

Special, multilayer wooden construction.



TECHNICAL INFORMATION

DOOR LEAF CONSTRUCTION

Door leaves contain rails, slim panels and 6 mm thick, frosted, tempered glass. Combination of those depends on a model.

ACCESSORIES INCLUDED IN THE DOOR LEAF PRICE

- Lock: key lock, WC lock, cylinder lock
- 3 barrel hinges or PRIME set available (see extra charges)
- Frosted tempered glass
- Preparation for shortening (maximum 60 mm)
- Round pull handle (for sliding doors)

DOOR FRAMES

Recommended rebated door frames:

- Porta SYSTEM see p. 178
- MINIMAX see p. 176
- STEEL see p. 190-195

Recommended non-rebated door frames:

- Porta SYSTEM ELEGANCE see p. 180
- LEVEL see p. 182

NOTES

- Technical Assessment AT-15-6515/2016, ITB Warsaw.
- Double doors are available in any door leaf size combinations.
- For a double non-rebated door, 'active' and 'passive' door leaves must be ordered.
- Magnetic lock is not available for a double door.

EXTRA CHARGES

- size '100'
- ventilation undercut or ventilation sleeves
- PRIME hinges (for dedicated door frames)
- PRIME lock with glossy faceplate (silver or gold)
- gold 3D hinges (an extra charge added to a door frame price)
- third 3D hinge - silver (an extra charge added to a door frame price)
- third 3D hinge - gold (an extra charge added to a door frame price)
- magnetic lock
- hook lock with side pull handles (sliding doors)
- oblong pull handle for sliding doors
- caps for standard hinges (set for 1 PCs)
- handle with an escutcheon

(see p. 200)

Porta CONCEPT, group H and K

TOP
COLLECTIONS



WE RECOMMEND

Traditional frame and panel construction guarantees long-time durability.

Porta CONCEPT K.3, English Oak Hamilton



Porta CONCEPT H.4, English Oak Hamilton



model H.0



model H.1



model H.2



model H.4



model K.0



model K.1



model K.2



model K.3

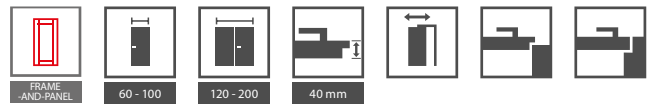

AVAILABLE FINISHES

Portadecor veneer ★★★★★☆

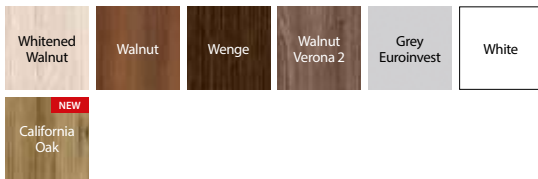

Portaperfect 3D veneer ★★★★★☆



Premium veneer ★★★★★☆



Portadur veneer ★★★★★☆

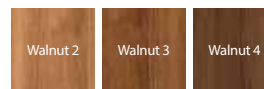

Portaperfect 3D veneer ★★★★★☆

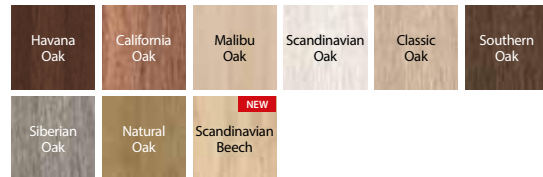

Portalamino ★★★★★☆

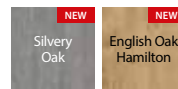

H.4 model - frosted glass panel



H.0 model - flat panel



K.3 model - frosted glass panel.3



K.0 - flat panel

WE RECOMMEND!

Special, multilayer wooden construction.



TECHNICAL INFORMATION

DOOR LEAF CONSTRUCTION

Door leaves contain rails, slim panels and 6 mm thick, frosted, tempered glass. Combination of those depends on a model.

ACCESSORIES INCLUDED IN THE DOOR LEAF PRICE

- Lock: key lock, WC lock, cylinder lock
- 3 barrel hinges or PRIME set available (see extra charges)
- Frosted tempered glass
- Preparation for shortening (maximum 60 mm)
- Round pull handle (for sliding doors)

DOOR FRAMES

Recommended rebated door frames:

- Porta SYSTEM see p. 178
- MINIMAX see p. 176
- STEEL see p. 190-195

Recommended non-rebated door frames:

- Porta SYSTEM ELEGANCE see p. 180
- LEVEL see p. 182

NOTES

- Technical Assessment AT-15-6515/2016, ITB Warsaw.
- Double doors are available in any door leaf size combinations.
- For a double non-rebated door, 'active' and 'passive' door leaves must be ordered.
- Magnetic lock is not available for a double door.

EXTRA CHARGES

- size '100'
- ventilation undercut or ventilation sleeves
- PRIME hinges (for dedicated door frames)
- PRIME lock with a glossy faceplate (silver or gold)
- gold 3D hinges (an extra charge added to a door frame price)
- third 3D hinge - silver (an extra charge added to a door frame price)
- third 3D hinge - gold (an extra charge added to a door frame price)
- magnetic lock
- hook lock with side pull handles (sliding doors)
- oblong pull handle for sliding doors
- caps for standard hinges (set for 1 PCS)
- handle with an escutcheon

(see p. 200)

Porta BALANCE



Porta BALANCE D.0, D.3, Wenge White



Porta BALANCE D.0, Wenge White



model A.0



model A.2



model B.0



model B.1



model C.0



model C.1



model C.2



model C.5



model D.0



model D.1



model D.2



model D.3

Check more models from this collection on a website



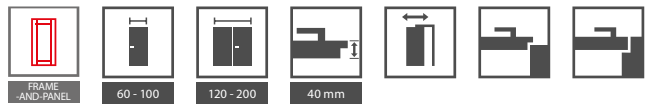

AVAILABLE FINISHES

Portadecor veneer ★★★★★☆



Portaperfect 3D veneer ★★★★★☆



Portaperfect 3D veneer ★★★★★☆

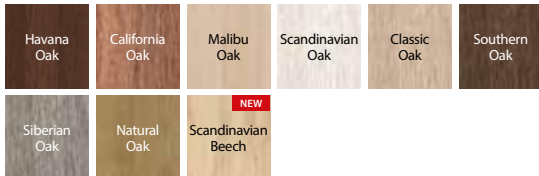

Portalamino ★★★★★☆

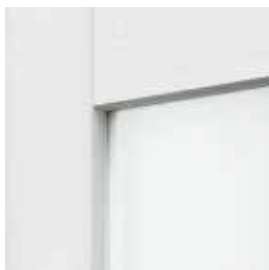
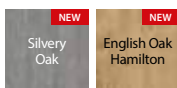

frosted glass panel



raised panel

TECHNICAL INFORMATION

DOOR LEAF CONSTRUCTION

Door leaves contain rails and stiles, slim panels and 4 mm thick, frosted, tempered glass. Combination of those depends on a model.

ACCESSORIES INCLUDED IN THE DOOR LEAF PRICE

- Lock: key lock, WC lock, cylinder lock,
- 3 barrel hinges or PRIME hinges (see extra charges)
- Frosted tempered glass
- Preparation for shortening (maximum 30 mm)
- Round pull handle (for sliding doors)

DOOR FRAMES

Recommended rebated door frames:

- Porta SYSTEM see p. 178
- MINIMAX see p. 176
- STEEL see p. 190-195

Recommended non-rebated door frames:

- Porta SYSTEM ELEGANCE see p. 180
- LEVEL see p. 182

NOTES

- Technical Assessment AT-15-6515/2016, ITB Warsaw.
- Double doors are available in any door leaf size combinations. For a double non-rebated door, 'active' and 'passive' door leaves must be ordered.
- Magnetic lock is not available for a double door.

EXTRA CHARGES

- size '100'
- ventilation undercut or ventilation sleeves
- PRIME hinges (for dedicated door frames)
- PRIME lock with glossy faceplate (silver or gold)
- gold 3D hinges (an extra charge added to a door frame price)
- third 3D hinge - silver (an extra charge added to a door frame price)
- third 3D hinge - gold (an extra charge added to a door frame price)
- magnetic lock
- hook lock with side pull handles (sliding doors)
- oblong pull handle for sliding doors
- caps for standard hinges (set for 1 PCs)
- handle with an escutcheon

(see p. 200)

Porta HARMONY



Porta HARMONY B.0, Siberian Oak



Porta HARMONY B.0, Siberian Oak



model A.0



model A.1



model A.2



model B.0



model B.1



model B.2



model B.3



model C.0



model C.1

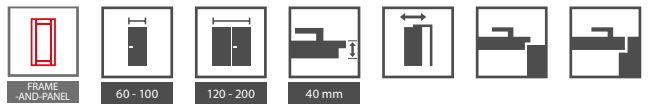

AVAILABLE FINISHES

Portadecor veneer ★★★★★☆



Portaperfect 3D veneer ★★★★★☆



Portaperfect 3D veneer ★★★★★☆

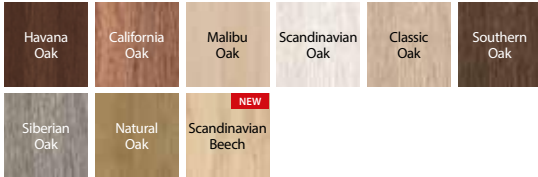

Portalamino ★★★★★☆



frosted glass panel



raised panel

TECHNICAL INFORMATION

DOOR LEAF CONSTRUCTION

Door leaves contain rails and stiles, slim panels and 4 mm thick, frosted, tempered glass. Combination of those depends on a model.

ACCESSORIES INCLUDED IN THE DOOR LEAF PRICE

- Lock: key lock, WC lock, cylinder lock,
- 3 barrel hinges or PRIME hinges (see extra charges)
- Frosted tempered glass
- Round pull handle (for sliding doors)
- Preparation for shortening (maximum 30 mm)

DOOR FRAMES

Recommended rebated door frames:

- Porta SYSTEM see p. 178
- MINIMAX see p. 176
- STEEL see p. 190-195

Recommended non-rebated door frames:

- Porta SYSTEM ELEGANCE see p. 180
- LEVEL see p. 182

NOTES

- Technical Assessment AT-15-6515/2016, ITB Warsaw.
- Double doors are available in any door leaf size combinations.
For a double non-rebated door, 'active' and 'passive' door leaves must be ordered.
- Magnetic lock is not available for a double door.

EXTRA CHARGES

- size '100'
- ventilation undercut or ventilation sleeves
- PRIME hinges (for dedicated door frames)
- PRIME lock with glossy faceplate (silver or gold)
- gold 3D hinges (an extra charge added to a door frame price)
- third 3D hinge - silver (an extra charge added to a door frame price)
- third 3D hinge - gold (an extra charge added to a door frame price)
- magnetic lock
- hook lock with side pull handles (sliding doors)
- oblong pull handle for sliding doors
- caps for standard hinges (set for 1 PCs)
- handle with an escutcheon

(see p. 200)

Porta INSPIRE, group A and B

TOP
COLLECTIONS



WE RECOMMEND

Traditional frame and panel construction guarantees long-time durability.

Porta INSPIRE A.0, Scandinavian Oak, retro module



Porta INSPIRE A.0, Scandinavian Oak



model A.0



model A.1



model A.1
with a mirror



model B.0



model B.1



model B.2



model B.3



AVAILABLE FINISHES

Portadecor veneer ★★★★★☆



Portaperfect 3D veneer ★★★★★☆



Portaperfect 3D veneer ★★★★★☆

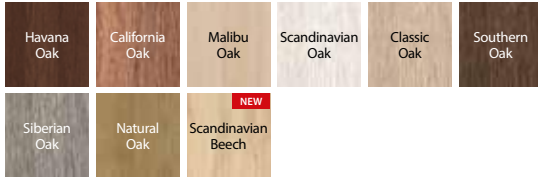

Portalamino ★★★★★☆



frosted glass panel, 'frame'



fancy decorative moulding

WE RECOMMEND!

Special, multilayer wooden construction.



TECHNICAL INFORMATION

DOOR LEAF CONSTRUCTION

Door leaves contain rails and stiles, slim panels and 6 mm thick, frosted, tempered glass. Combination of those depends on a model. It is possible to produce model A.1 with mirror on one or on both sides. If a mirror is only on one side, there is a solid board on the other side.

ACCESSORIES INCLUDED IN THE DOOR LEAF PRICE

- Lock: key lock, WC lock, cylinder lock,
- 3 barrel hinges or PRIME hinges (see extra charges)
- Frosted tempered glass and frosted glass
- Preparation for shortening (maximum 60 mm)
- Round pull handle (for sliding doors)

DOOR FRAMES

Recommended rebated door frames:

- Porta SYSTEM see p. 178
- MINIMAX see p. 176
- STEEL see p. 190-195

Recommended non-rebated door frames:

- Porta SYSTEM ELEGANCE see p. 180
- LEVEL see p. 182

NOTES

- Technical Assessment AT-15-6515/2016, ITB Warsaw.
- For a double non-rebated door, 'active' and 'passive' door leaves must be ordered
- **If a mirror is only on one side, there is a solid board on the other side.**
- Magnetic lock is not available for a double door.

EXTRA CHARGES

- size '100'
- ventilation undercut or ventilation sleeves
- PRIME hinges (for dedicated door frames)
- PRIME lock with glossy faceplate (silver or gold)
- gold 3D hinges (an extra charge added to a door frame price)
- third 3D hinge - silver (an extra charge added to a door frame price)
- third 3D hinge - gold (an extra charge added to a door frame price)
- magnetic lock
- hook lock with side pull handles (sliding doors)
- oblong pull handle for sliding doors
- caps for standard hinges (set for 1 PCs)
- mirror on one side
- mirror on both sides
- handle with an escutcheon

(see p. 200)

Porta INSPIRE, group C

TOP
COLLECTIONS



Porta INSPIRE C.4, Classic Oak



Porta INSPIRE C.4, Classic Oak



model C.0



model C.1



model C.2



model C.3



model C.4

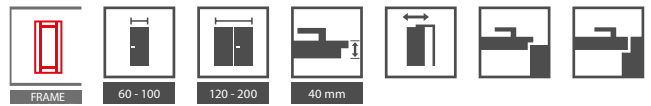

AVAILABLE FINISHES

Portadecor veneer ★★★★★☆



Portaperfect 3D veneer ★★★★★☆



Premium veneer ★★★★★☆



Portaperfect 3D veneer ★★★★★☆

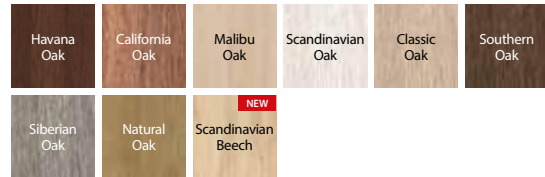

Portalamino ★★★★★☆

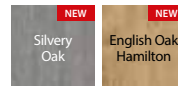

frosted glass panel



fancy panel

WE RECOMMEND!

Special, multilayer wooden construction.



TECHNICAL INFORMATION

DOOR LEAF CONSTRUCTION

Door leaves contain rails and stiles, slim panels and 6 mm thick, frosted, tempered glass. Combination of those depends on a model.

ACCESSORIES INCLUDED IN THE DOOR LEAF PRICE

- Lock: key lock, WC lock, cylinder lock,
- 3 barrel hinges or PRIME hinges (see extra charges)
- Frosted tempered glass
- Round pull handle (for sliding doors)
- Preparation for shortening (maximum 60 mm)

DOOR FRAMES

Recommended rebated door frames:

- Porta SYSTEM see p. 178
- MINIMAX see p. 176
- STEEL see p. 190-195

Recommended non-rebated door frames:

- Porta SYSTEM ELEGANCE see p. 180
- LEVEL see p. 182

NOTES

- Technical Assessment AT-15-6515/2016, ITB Warsaw.
- For a double non-rebated door, 'active' and 'passive' door leaves must be ordered.
- Magnetic lock is not available for a double door.

EXTRA CHARGES

- size '100'
- ventilation undercut or ventilation sleeves
- PRIME hinges (for dedicated door frames)
- PRIME lock with glossy faceplate (silver or gold)
- gold 3D hinges (an extra charge added to a door frame price)
- third 3D hinge - silver (an extra charge added to a door frame price)
- third 3D hinge - gold (an extra charge added to a door frame price)
- magnetic lock
- hook lock with side pull handles (sliding doors)
- oblong pull handle for sliding doors
- caps for standard hinges (set for 1 PCs)
- handle with an escutcheon

(see p. 200)

FLUSH INTERIOR DOORS SYNTHETIC VENEER

We have a wide choice of synthetic veneer doors, among which everyone will find something for themselves. Easy cleaning, durability and attractive price make these models very popular.



THEY SAY I'M A CHATTERBOX BUT I JUST APPRECIATE BEING IN TOUCH WITH OTHERS. THAT'S WHY I HAVE CHOSEN DOORS THAT MUFFLE MY FREQUENT CONVERSATIONS.



Porta DECOR

TOP
COLLECTIONS



Porta DECOR P, Scandinavian Beech

WE RECOMMEND

Chosen models with a hollow core are classified with 3rd strength performance class. Additionally, available the 'investment set' containing 3 part hinges and a lock of the highest category of use (at an extra charge). The set consists of a door leaf and a dedicated door frame.



Porta DECOR P, Scandinavian Beech



model P



model M



model D



model L

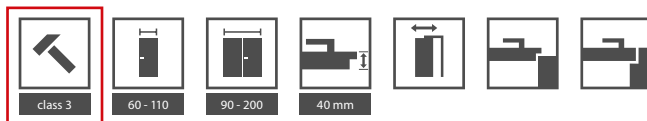

AVAILABLE FINISHES

Portadecor veneer ★★★★★☆

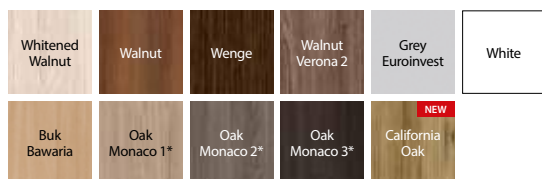

* do wyczerpania zapasów

Portaperfect 3D veneer ★★★★★☆

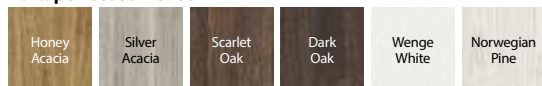

Portaperfect 3D veneer ★★★★★☆

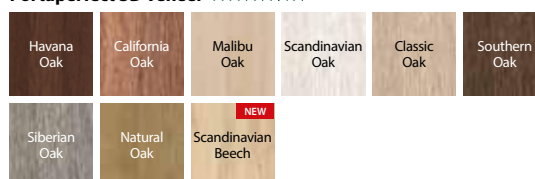

Portalamino ★★★★★☆

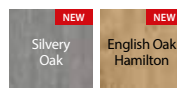

glazing bead with a glass panel



'Chinchilla' glass panel

TECHNICAL INFORMATION

DOOR LEAF CONSTRUCTION

Honeycomb or hollow chipboard core reinforced with rails and stiles. The construction is skinned with HDF.

ACCESSORIES INCLUDED IN THE DOOR LEAF PRICE

- Two or three standard barrel hinges, PRIME set available ->see extra charges
- Three hinges for size '100' or '110'
- Lock: key lock, WC lock, or cylinder lock
- 'Chinchilla' glass or frosted tempered glass (optionally at an extra charge)
- Round pull handle (for sliding doors)

DOOR FRAMES

Recommended rebated door frames:

- Porta SYSTEM see p. 178
- MINIMAX see p. 176
- STEEL see p. 190-195

Recommended non-rebated door frames:

- Porta SYSTEM ELEGANCE see p. 180
- LEVEL see p. 182

NOTES

- Technical Assessment AT-15-6515/2016, ITB Warsaw.
- Hollow chipboard core has preparation for shortening as a standard.
- Size '110' is available only with hollow chipboard core. Glazing size is the same as for size '100'.
- Double doors are available in any door leaf size combinations.
Passive door leaves (side panel) in sizes '30', '40', '50' available only in flat option

(without glazing or decorative applications).

- For a double non-rebated door, 'active' and 'passive' door leaves must be ordered.
- Magnetic lock is not available for a double door.
- **Size '80' and '90' in investment norm (clear opening width 800, 900 mm) available as a standard- without extra charge.**
- Reinforcement for door closer requires third hinge.

EXTRA CHARGES

- size '100' and '110'
- hollow chipboard core
- ventilation grille, ventilation sleeves or ventilation undercut
- PRIME hinges (applies to dedicated door frames)
- PRIME lock with glossy faceplate (silver or gold)
- gold 3D hinges (an extra charge added to a door frame price)
- third 3D hinge - silver (an extra charge added to a door frame price)
- third 3D hinge - gold (an extra charge added to a door frame price)
- magnetic lock
- preparation for shortening (maximum 60 mm)
- reinforcement for door closer (third hinge is required)
- stainless steel porthole
- hook lock with side pull handles (sliding doors)
- oblong pull handle for sliding doors
- caps for standard hinges (set for 1 PCs)
- frosted tempered glass - model M
- frosted tempered glass - model D
- frosted tempered glass - model L
- handle with an escutcheon

(see p. 200)

Porta TWIST, Porta GRANDDECO



Porta TWIST A.3, Walnut Verona 2



Porta TWIST A.3, Walnut Verona 2



TWIST A.0



TWIST A.1



TWIST A.3



TWIST C.1



GRANDDECO 1.1



GRANDDECO 1.2



GRANDDECO 2.1



GRANDDECO 2.3



GRANDDECO 3.1



GRANDDECO 3.2



GRANDDECO 5.2



GRANDDECO 6.2

Check more models
from this collection
on a website



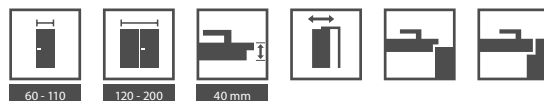

AVAILABLE FINISHES

Portadecor veneer ★★★★★☆

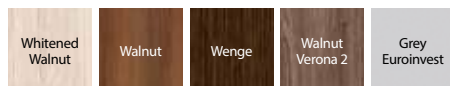

Portaperfect 3D veneer ★★★★★☆

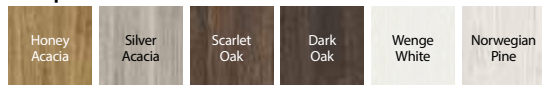

Portaperfect 3D veneer ★★★★★☆

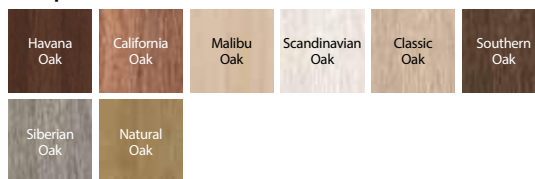

glazing bead with a glass panel –
Porta TWIST A.3



glazing bead with a slim panel –
Porta TWIST A.0



frosted glass panel
Porta GRANDDECO 3.2



decorative moulding
Porta GRANDDECO 3.1

TECHNICAL INFORMATION

DOOR LEAF CONSTRUCTION - TWIST

Honeycomb or chipboard (at an extra charge) combined with a stabilising insert. All is reinforced with rails and stiles and skinned with HDF. The construction also includes a glass panel or a flat panel.

DOOR LEAF CONSTRUCTION - GRANDDECO

Honeycomb. Hollow chipboard core reinforced with rails and stiles is available at an extra charge (models 1.1, 2.1, 3.1, 4.1, 5.1, 6.1). The construction is skinned with HDF.

ACCESSORIES INCLUDED IN THE DOOR LEAF PRICE

- Two or three standard barrel hinges, PRIME set available ->see extra charges.
- Three hinges for size '100' or '110'.
- Lock: key lock, WC lock, or cylinder lock.
- Glazing - Porta TWIST: frosted tempered glass, Porta GRANDDECO: frosted, tempered glass or 'chinchilla' glass.
- Round pull handle (for sliding doors).

DOOR FRAMES

Recommended rebated door frames:

- Porta SYSTEM see p. 178
- MINIMAX see p. 176
- STEEL see p. 190-195

Recommended non-rebated door frames:

- Porta SYSTEM ELEGANCE see p. 180
- LEVEL see p. 182

NOTES

- Technical Assessment AT-15-6515/2016, ITB Warsaw.
- Double doors are available in any door leaf size combinations.
For a double non-rebated door, 'active' and 'passive' door leaves must be ordered
- Magnetic lock is not available for a double door
- Reinforcement for door closer requires third hinge

Additional information regarding Porta TWIST collection:

- Chipboard core has preparation for shortening as a standard
- Size '60' and '120' (double) is not available for A models
- Size '110' is available only with chipboard core.
- Due to various materials use, there might be a slight colour difference between door leaf and a glazing bead.

Additional information regarding Porta GRANDDECO collection:

- Hollow chipboard core has preparation for shortening as a standard
- Size '110' is available only with hollow chipboard.
Glazing size is the same as for size '100'

EXTRA CHARGES

- size '100' and '110'
- Twist - hollow chipboard core or chipboard core
- Granddeco - chipboard core (glazed door leaves)
- ventilation grille, ventilation sleeves or ventilation undercut
- PRIME hinges (applies to dedicated door frames)
- PRIME lock with glossy faceplate (silver or gold)
- gold 3D hinges (an extra charge added to a door frame price)
- third 3D hinge - silver (an extra charge added to a door frame price)
- third 3D hinge - gold (an extra charge added to a door frame price)
- magnetic lock
- preparation for shortening (maximum 60 mm)
- reinforcement for door closer (third hinge is required)
- stainless steel porthole
- hook lock with side pull handles (sliding doors)
- oblong pull handle for sliding doors
- caps for standard hinges (set for 1 PCs)
- handle with an escutcheon

(see p. 200)

Porta STYL



Porta STYL 1, California Oak



Porta STYL 1, California Oak



model 1



model 2



model 3



model 4

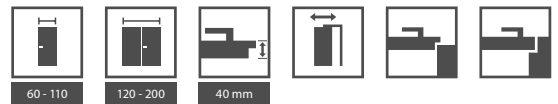

AVAILABLE FINISHES

Portadecor veneer ★★★★★☆

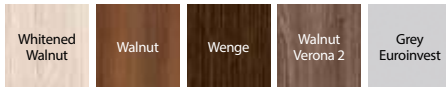

Portaperfect 3D veneer ★★★★★☆



Portaperfect 3D veneer ★★★★★☆

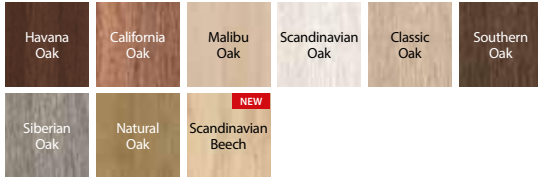

CPL HQ 0,2 veneer ★★★★★☆

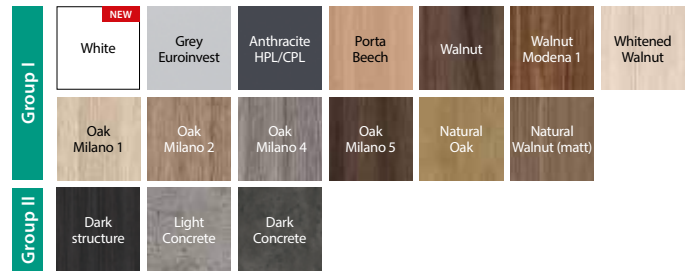

Porta STYL



glazed model

NOTE

If you're looking for a flush door that matches this collection, check Porta DECOR see p. 70 and Porta CPL see p. 88.

TECHNICAL INFORMATION

DOOR LEAF CONSTRUCTION

Honeycomb or hollow chipboard core reinforced with rails and stiles (at an extra charge). The construction is skinned with HDF. There is lipping ABS on the side edges of the doors finished with CPL.

ACCESSORIES INCLUDED IN THE DOOR LEAF PRICE

- Two or three standard barrel hinges, PRIME set available ->see extra charges
- Three hinges for size '100' or '110'
- Lock: key lock, WC lock, or cylinder lock
- 'Chinchilla' glass or frosted tempered glass
- Round pull handle (for sliding doors)

DOOR FRAMES

Recommended rebated door frames:

- Porta SYSTEM see p. 178
- MINIMAX see p. 176
- STEEL see p. 190-195

Recommended non-rebated door frames:

- Porta SYSTEM ELEGANCE see p. 180
- LEVEL see p. 182

NOTES

- Technical Assessment AT-15-6515/2016, ITB Warsaw.
- Hollow chipboard core has preparation for shortening as a standard.
- Size '110' is available only with hollow chipboard core. Glazing size is the same as for size '100'.

- Double doors are available in any door leaf size combinations. For a double non-rebated door, 'active' and 'passive' door leaves must be ordered.
- Magnetic lock is not available for a double door.
- Reinforcement for door closer requires third hinge.

EXTRA CHARGES

- size '100' and '110'
- hollow chipboard core
- CPL 0,2 mm finish - GROUP II
- ventilation grille, ventilation sleeves or ventilation undercut
- PRIME hinges (applies to dedicated door frames)
- PRIME lock with glossy faceplate (silver or gold)
- gold 3D hinges (an extra charge added to a door frame price)
- third 3D hinge - silver (an extra charge added to a door frame price)
- third 3D hinge - gold (an extra charge added to a door frame price)
- magnetic lock
- **OFFER** - doors with CPL finish- PRIME set
- preparation for shortening (maximum 60 mm)
- reinforcement for door closer (third hinge is required)
- hook lock with side pull handles (sliding doors)
- oblong pull handle for sliding doors
- caps for standard hinges (set for 1 PCs)
- handle with an escutcheon

(see p. 200)

Porta FIT, group A, B, C, I



Porta FIT I.1, Grey Euroinvest



Porta FIT I.1, Grey Euroinvest



model A.2



model A.6

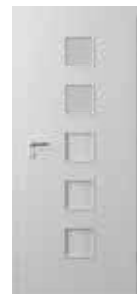

model B.2



model B.5

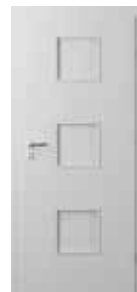

model C.0

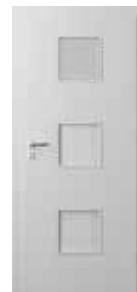

model C.1

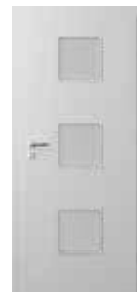

model C.3



model I.0



model I.1

Check more models from this collection on a website



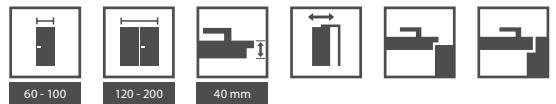

AVAILABLE FINISHES

Portadecor veneer ★★★★★☆

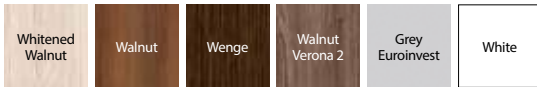

Portaperfect 3D veneer ★★★★★☆



Portaperfect 3D veneer ★★★★★☆

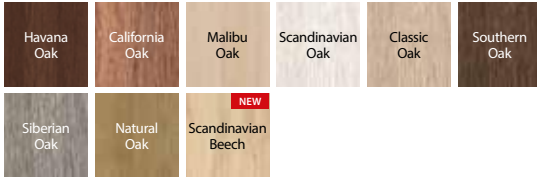

CPL HQ 0,2 veneer ★★★★★☆

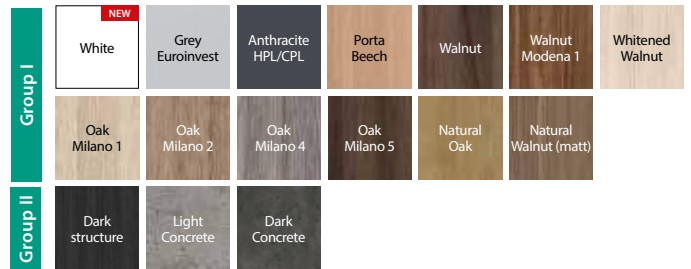

glazing bead with glass panels
NOTE: in case of CPL finish the glazing bead is rounded



glazing bead with a slim panel
NOTE: in case of CPL finish the glazing bead is rounded

NOTE

If you're looking for a flush door that matches this collection, check Porta DECOR see p. 70 and Porta CPL see p. 88.

TECHNICAL INFORMATION

DOOR LEAF CONSTRUCTION

Models A, B, C and I honeycomb and stabilising insert or chipboard core (at an extra charge). The construction is reinforced with rails and stiles and skinned with HDF. There is lipping ABS on the side edges of the doors finished with CPL.

ACCESSORIES INCLUDED IN THE DOOR LEAF PRICE

- Two or three standard barrel hinges, PRIME set available ->see extra charges
- Three hinges for size '100'
- Lock: key lock, WC lock, or cylinder lock
- 'Chinchilla' glass or frosted tempered glass
- Round pull handle (for sliding doors)

DOOR FRAMES

Recommended rebated door frames:

- Porta SYSTEM see p. 178
- MINIMAX see p. 176
- STEEL see p. 190-195

Recommended non-rebated door frames:

- Porta SYSTEM ELEGANCE see p. 180
- LEVEL see p. 182

NOTES

- Technical Assessment AT-15-6515/2016, ITB Warsaw.
- Double doors are available in any door leaf size combinations. For a double non-rebated door, 'active' and 'passive' door leaves must be ordered.
- Magnetic lock is not available for a double door.
- Reinforcement for door closer requires third hinge.

EXTRA CHARGES

- size '100'
- hollow chipboard core or chipboard core
- CPL 0,2 mm finish - GROUP II
- ventilation grille, ventilation sleeves or ventilation undercut
- PRIME hinges (applies to dedicated door frames)
- PRIME lock with glossy faceplate (silver or gold)
- gold 3D hinges (an extra charge added to a door frame price)
- third 3D hinge - silver (an extra charge added to a door frame price)
- third 3D hinge - gold (an extra charge added to a door frame price)
- magnetic lock
- **OFFER** - doors with CPL finish - PRIME set
- preparation for shortening (maximum 60 mm)
- reinforcement for door closer (third hinge is required)
- hook lock with side pull handles (sliding doors)
- oblong pull handle for sliding doors
- caps for standard hinges (set for 1 PCs)
- handle with an escutcheon

(see p. 200)

Porta FIT, group E-H



Porta FIT G.5, Norwegian Pine



Porta FIT G.5, Norwegian Pine



model E.0



model E.3



model F.2



model F.6



model G.0



model G.2



model G.3



model G.5



model H.0



model H.1



model H.3



model H.4

Check more models from this collection on a website



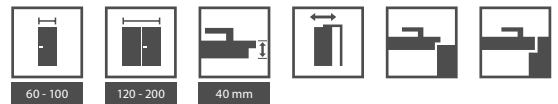

AVAILABLE FINISHES

Portadecor veneer ★★★★★☆

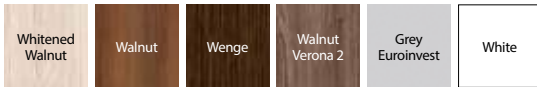

Portaperfect 3D veneer ★★★★★☆



Portaperfect 3D veneer ★★★★★☆

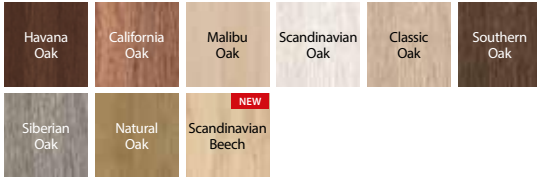

CPL HQ 0,2 veneer ★★★★★☆

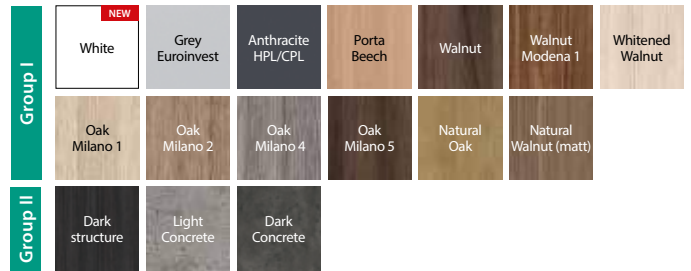

Porta FIT



glazing bead with a glass panel
NOTE: in case of CPL finish the glazing bead is rounded



glazing bead with a glass panel
NOTE: in case of CPL finish the glazing bead is rounded

NOTE

If you're looking for a flush door that matches this collection, check Porta DECOR see p. 70 and Porta CPL see p. 88.

TECHNICAL INFORMATION

DOOR LEAF CONSTRUCTION

Models A, B, C and I honeycomb and stabilising insert or chipboard core (at an extra charge). The construction is reinforced with rails and stiles and skinned with HDF. There is lipping ABS on the side edges of the doors finished with CPL.

ACCESSORIES INCLUDED IN THE DOOR LEAF PRICE

- Two or three standard barrel hinges, PRIME set available ->see extra charges
- Three hinges for size '100'
- Lock: key lock, WC lock, or cylinder lock
- 'Chinchilla' glass or frosted tempered glass
- Round pull handle (for sliding doors)

DOOR FRAMES

Recommended rebated door frames:

- Porta SYSTEM see p. 178
- MINIMAX see p. 176
- STEEL see p. 190-195

Recommended non-rebated door frames:

- Porta SYSTEM ELEGANCE see p. 180
- LEVEL see p. 182

NOTES

- Technical Assessment AT-15-6515/2016, ITB Warsaw.
- Ventillation grille and 2 rows of ventilation sleeves are not available for model H
- Double doors are available in any door leaf size combinations.
- For a double non-rebated door, 'active' and 'passive' door leaves must be ordered. Magnetic lock is not available for a double door.
- Reinforcement for door closer requires third hinge.

EXTRA CHARGES

- size '100'
- hollow chipboard core or chipboard core
- CPL 0,2 mm finish - GROUP II
- ventilation grille, ventilation sleeves or ventilation undercut
- PRIME hinges (applies to dedicated door frames)
- PRIME lock with glossy faceplate (silver or gold)
- gold 3D hinges (an extra charge added to a door frame price)
- third 3D hinge - silver (an extra charge added to a door frame price)
- third 3D hinge - gold (an extra charge added to a door frame price)
- magnetic lock
- **OFFER** - doors with CPL finish- PRIME set
- preparation for shortening (maximum 60 mm)
- reinforcement for door closer (third hinge is required)
- hook lock with side pull handles (sliding doors)
- oblong pull handle for sliding doors
- caps for standard hinges (set for 1 PCs)
- handle with an escutcheon

(see p. 200)



Porta NOVA, group 2-5



Porta NOVA 2.1, Silvery Oak



Porta NOVA 5.5, Silvery Oak



model 2.1



model 2.2



model 2.2
with a mirror



model 3.1



model 3.2



model 4.1



model 4.2



model 4.4



model 5.1



model 5.2



model 5.4



model 5.5

Check more models
from this collection
on a website



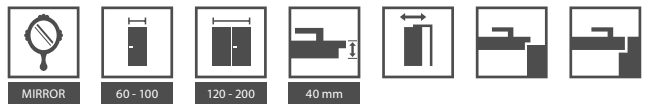

AVAILABLE FINISHES

Portadecor veneer ★★★★★☆

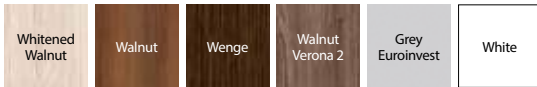

Portaperfect 3D veneer ★★★★★☆



Portadur veneer ★★★★★☆

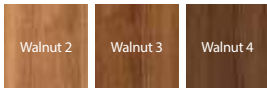

Portaperfect 3D veneer ★★★★★☆

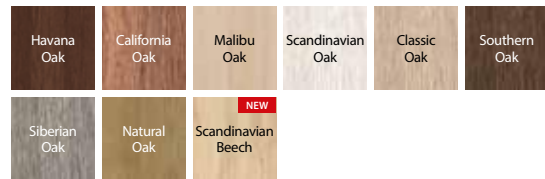

Portalamino ★★★★★☆

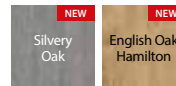

decorative moulding with a slim panel

TECHNICAL INFORMATION

DOOR LEAF CONSTRUCTION

Chipboard core reinforced with rails and stiles. The construction is skinned with HDF. It is possible to produce model 2.2 with a mirror on one or on both sides. If the mirror is only on one side, there will be slim panel on the other side.

ACCESSORIES INCLUDED IN THE DOOR LEAF PRICE

- Lock: key lock, WC lock, or cylinder lock
- Two/ three standard barrel hinges, or three hinges for size '100' and for door leaves in Portadur finish. PRIME set available ->see extra charges
- Glazing -'chinchilla' glass or frosted tempered glass (at an extra charge)
- Preparation for shortening - maximum 60 mm (group 2 and 3 only)
- Round pull handle (for sliding doors)

DOOR FRAMES

Recommended rebated door frames:

- Porta SYSTEM see p. 178
- MINIMAX see p. 176
- STEEL see p. 190-195

Recommended non-rebated door frames:

- Porta SYSTEM ELEGANCE see p. 180
- LEVEL see p. 182

NOTES

- Technical Assessment AT-15-6515/2016, ITB Warsaw.
- Double doors are available in any door leaf size combinations. For a double non-rebated door, 'active' and 'passive' door leaves must be ordered.
- Magnetic lock is not available for a double door.
- Reinforcement for door closer requires third hinge.

EXTRA CHARGES

- size '100'
- frosted glass, model 2.2
- frosted glass, model 3.2
- frosted glass, models from group 4 and 5 (1 PCs of a glass panel)
- ventilation sleeves (1 row) or ventilation undercut
- PRIME hinges (applies to dedicated door frames)
- PRIME lock with glossy faceplate (silver or gold)
- gold 3D hinges (an extra charge added to a door frame price)
- third 3D hinge - silver (an extra charge added to a door frame price)
- third 3D hinge - gold (an extra charge added to a door frame price)
- reinforcement for door closer (third hinge is required)
- magnetic lock
- hook lock with side pull handles (sliding doors)
- oblong pull handle for sliding doors
- caps for standard hinges (set for 1 PCs)
- a mirror on one side
- a mirror on both sides
- handle with an escutcheon

(see p. 200)

Porta NOVA, group 6 and 7



Porta NOVA 7.1, Walnut 3, retro module



Porta NOVA 6.3 Walnut 3, retro module



model 6.1



model 6.2



model 6.3



model 6.4



model 6.5



model 7.1



model 7.2



model 7.3

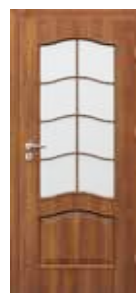

model 7.4



model 7.5

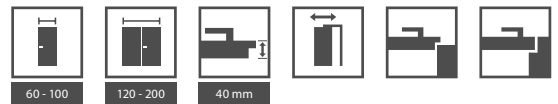

AVAILABLE FINISHES

Portadecor veneer ★★★★★☆

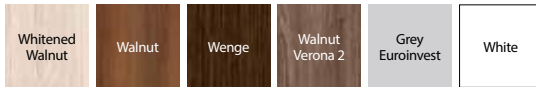

Portaperfect 3D veneer ★★★★★☆

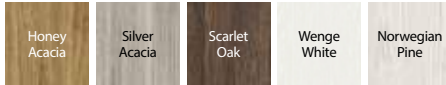

Portadur veneer ★★★★★☆

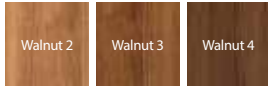

Portaperfect 3D veneer ★★★★★☆

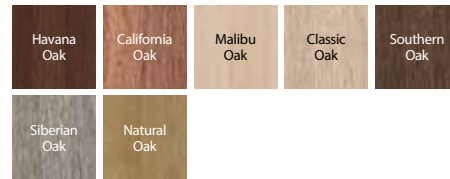

glazing bead with a glass panel



glazing bead with a raised panel

TECHNICAL INFORMATION

DOOR LEAF CONSTRUCTION

Chipboard core reinforced with rails and stiles. The construction is skinned with HDF.

ACCESSORIES INCLUDED IN THE DOOR LEAF PRICE

- Lock: key lock, WC lock, or cylinder lock
- Two/ three standard barrel hinges, or three hinges for size '100' and for door leaves in Portadur finish. PRIME set available ->see extra charges
- Glazing -'chinchilla' glass or frosted glass (at an extra charge)
- Preparation for shortening - maximum 60 mm
- Round pull handle (for sliding doors)

DOOR FRAMES

Recommended rebated door frames:

- Porta SYSTEM see p. 178
- MINIMAX see p. 176
- STEEL see p. 190-195

Recommended non-rebated door frames:

- Porta SYSTEM ELEGANCE see p. 180
- LEVEL see p. 182

NOTES

- Technical Assessment AT-15-6515/2016, ITB Warsaw.
- Finishes: Portasynchro Dark Oak and Portaperfect Scandinavian Oak are not available for models from group 6 and 7.
- Ventilation grille and 2 rows of ventilation sleeves are available only for models 6.5, 7.5
- Double doors are available in any door leaf size combinations.
For a double non-rebated door, 'active' and 'passive' door leaves must be ordered.
- Magnetic lock is not available for a double door.
- Reinforcement for door closer requires third hinge
- Due to various materials use, there might be a slight colour difference between door leaf and a glazing bead/muntins.

EXTRA CHARGES

- size '100'
- frosted glass
- ventilation grille, ventilation sleeves or ventilation undercut
- PRIME hinges (applies to dedicated door frames)
- PRIME lock with glossy faceplate (silver or gold)
- gold 3D hinges (an extra charge added to a door frame price)
- third 3D hinge - silver (an extra charge added to a door frame price)
- third 3D hinge - gold (an extra charge added to a door frame price)
- reinforcement for door closer (third hinge is required)
- magnetic lock
- hook lock with side pull handles (sliding doors)
- oblong pull handle for sliding doors
- caps for standard hinges (set for 1 PCs)
- frosted tempered glass
- handle with an escutcheon

(see p. 200)

Porta LEVEL



WE RECOMMEND

Thanks to new attractive finishes and dedicated door frame LEVEL with 20 cm or 100 cm panel, Porta LEVEL collection gives opportunities for extraordinary interior designs.

Porta LEVEL C.2, Catania Oak. Dedicated door frame LEVEL with top panel 100 cm.



Porta LEVEL C.2 with a decorative inlay, Catania Oak
Door frame with the top panel - 20 cm.



Porta Decor
model P
see page 70



model C.1
Door frame with
top panel 20 cm



model C.2
with a decorative
inlay
Door frame with
the top panel
- 20 cm.



model C.3
with a decorative
inlay
Door frame with
the top panel
- 20 cm.

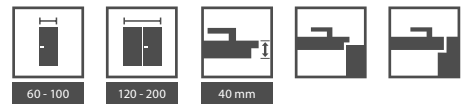

AVAILABLE FINISHES

Portadecor veneer ★★★★★☆



Portaperfect 3D veneer ★★★★★☆



Portalamino ★★★★★☆



NOTE

If you're looking for a flush door that matches this collection, check Porta DECOR see page 70.

We offer dedicated door frame LEVEL for Level door leaves. The top panel Level is available with two graining directions – horizontal or vertical – applies to 6 chosen finishes.



dedicated door frame LEVEL



black decorative inlays



silver decorative inlays

TECHNICAL INFORMATION

DOOR LEAF CONSTRUCTION

Honeycomb or hollow chipboard core reinforced with rails and stiles. The construction is skinned with HDF.

ACCESSORIES INCLUDED IN THE DOOR LEAF PRICE

- Two or three barrel hinges, PRIME set available ->see extra charges
- Three hinges for size '100'
- Lock: key lock, WC lock, or cylinder lock

DOOR FRAMES

Recommended rebated door frames:

- Porta SYSTEM see p. 178
- MINIMAX see p. 176
- STEEL see p. 190-195

Recommended non-rebated door frames:

- Porta SYSTEM ELEGANCE see p. 180
- LEVEL see p. 182

NOTES

- Technical Assessment AT-15-6515/2016, ITB Warsaw.
- Hollow chipboard core and chipboard core have a preparation for shortening as a standard.
- Double doors are available in any door leaf size combinations.
- Magnetic lock is not available for a double door.
- Reinforcement for door closer requires third hinge.

EXTRA CHARGES

- size '100'
- hollow chipboard core
- ventilation sleeves or ventilation undercut
- PRIME hinges (for dedicated door frames)
- PRIME lock with glossy faceplate (silver or gold)
- gold 3D hinges (an extra charge added to door frame price)
- third 3D hinge - silver (an extra charge added to door frame price)
- third 3D hinge - gold (an extra charge added to door frame price)
- magnetic lock
- preparation for shortening (maximum 60 mm)
- reinforcement for door closer (third hinge is required)
- caps for standard hinges (set for 1 PCs)
- handle with an escutcheon

(see p. 200)

Porta LINE

TOP
COLLECTIONS

TOP
INVESTMENT
COLLECTIONS



WE RECOMMEND

Chosen models with a hollow core are classified with 3rd strength performance class. Additionally, available the 'investment set' containing 3 part hinges and a lock of the highest category of use (at an extra charge). The set consists of a door leaf and a dedicated door frame.

Porta LINE G.1, Dark Concrete



Porta LINE H.1, Dark Concrete



model A.1



model B.1



model C.1



model D.1



model E.1



model F.1



model G.1



model H.1

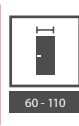

AVAILABLE FINISHES

Portadecor veneer ★★★★★☆



Portaperfect 3D veneer ★★★★★☆



Portaperfect 3D veneer ★★★★★☆

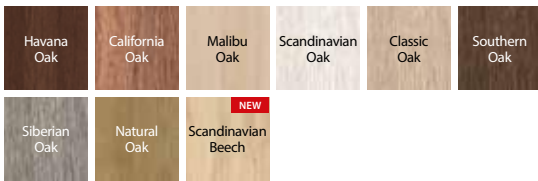

CPL HQ 0,2 veneer ★★★★★☆

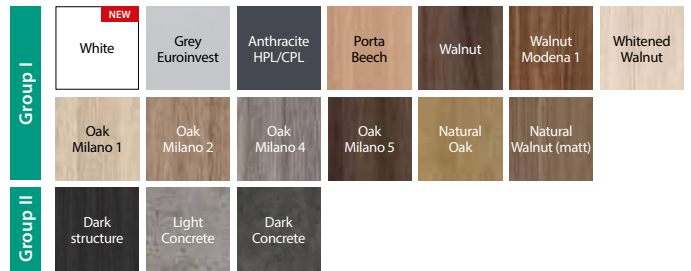

Portalamino ★★★★★☆

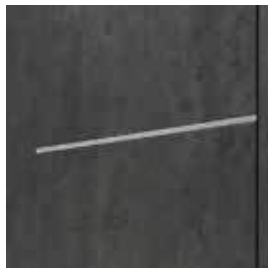
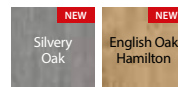

silver decorative inlays, black also available

TECHNICAL INFORMATION

DOOR LEAF CONSTRUCTION

Honeycomb or hollow chipboard core reinforced with rails and stiles. Then construction is skinned with HDF. Door leaves are enriched with silver or black decorative inlays, 6 mm wide. There is liping ABS on the side edges of the doors finished with CPL.

ACCESSORIES INCLUDED IN THE DOOR LEAF PRICE

- Two or three standard barrel hinges, PRIME set available ->see extra charges
- Three hinges for size '100'
- Lock: key lock, WC lock, or cylinder lock
- Round pull handle (for sliding doors)

DOOR FRAMES

Recommended rebated door frames:

- Porta SYSTEM see p. 178
- MINIMAX see p. 176
- STEEL see p. 190-195

Recommended non-rebated door frames:

- Porta SYSTEM ELEGANCE see p. 180
- LEVEL see p. 182

NOTES

- Technical Assessment AT-15-6515/2016, ITB Warsaw.
- Ventilation sleeves are not available for D.1 model
- Sliding option of models F.1 and G.1 - decorative inlays placed on pull handle height
- Preparation for shortening is extra charged in case of ordering honeycomb core

- Hollow chipboard core and chipboard core have a preparation for shortening as a standard
- Size '110' is available only with hollow chipboard.
- Double doors are available in any door leaf size combinations. For a double non-rebated door, 'active' and 'passive' door leaves must be ordered.
- Magnetic lock is not available for a double door.
- Reinforcement for door closer requires third hinge.

EXTRA CHARGES

- size '100' and '110'
- hollow chipboard core
- CPL 0,2 mm finish - GROUP II
- ventilation sleeves or ventilation undercut
- PRIME hinges (applies to dedicated door frames)
- PRIME lock with glossy faceplate (silver or gold)
- gold 3D hinges (an extra charge added to a door frame price)
- third 3D hinge - silver (an extra charge added to a door frame price)
- third 3D hinge - gold (an extra charge added to a door frame price)
- magnetic lock
- OFFER - doors with CPL finish- PRIME set
- preparation for shortening (maximum 60 mm)
- reinforcement for door closer (third hinge is required)
- hook lock with side pull handles (sliding doors)
- an oblong pull handle for sliding doors
- caps for standard hinges (set for 1 PCs)
- a handle with an escutcheon

(see p. 200)

Porta CPL

TOP
COLLECTIONS

TOP
INVESTMENT
COLLECTIONS



WE RECOMMEND

Chosen models with a hollow core are classified with 3rd strength performance class. Additionally, available the 'investment set' containing 3 part hinges and a lock of the highest category of use (at an extra charge). The set consists of a door leaf and a dedicated door frame.

Porta CPL 1.1, door leaf - Natural Oak, door frame - Dark concrete



Porta CPL 1.1, Natural Oak



model 1.1



model 1.2



model 1.3



model 1.4



model 1.5



model 5.1



model 5.2



model 5.4



model 5.5



AVAILABLE FINISHES

CPL HQ 0,2 veneer ★★★★★☆

HPL, CPL 0,7 veneer ★★★★★★

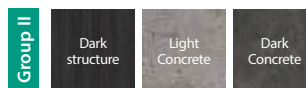
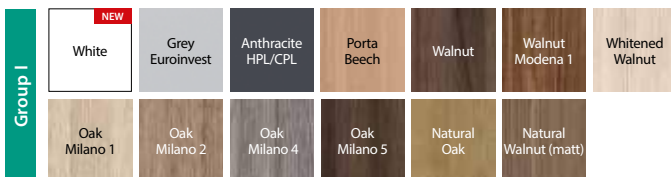

Check the possibilities of ordering bespoke door models through Porta CONTRACT, see page 226.

Porta CPL



glazing bead with a glass panel



a glazing bead with a raised panel



push panel



ventilation kick panel

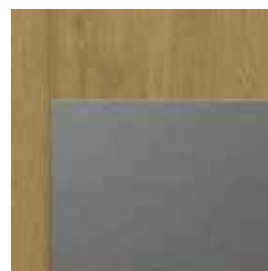

kick panel

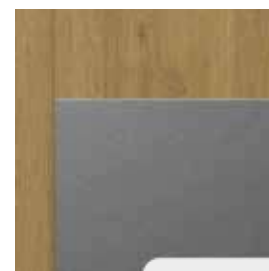

kick panel with a ventilation undercut

TECHNICAL INFORMATION

DOOR LEAF CONSTRUCTION

Group 1 - honeycomb or hollow chipboard core (at an extra charge) reinforced with rails and stiles. Group 5 and model 1.4 - chipboard core. The construction is skinned with HDF. lipping ABS on the side edges.

ACCESSORIES INCLUDED IN THE DOOR LEAF PRICE

- Lock: key lock, WC lock, or cylinder lock
- Two or three barrel or PRIME hinges
- Three hinges for size '100' or '110'
- Glazing - 'chinchilla' glass or frosted/transparent tempered glass (optionally at an extra charge)
- Preparation for shortening - max. 60 mm (only group 5)
- Round pull handle (for sliding doors)

DOOR FRAMES

Recommended rebated door frames:

- Porta SYSTEM see p. 178
- MINIMAX see p. 176
- STEEL see p. 190-195

Recommended non-rebated door frames:

- Porta SYSTEM ELEGANCE see p. 180

NOTES

- Technical Assessment AT-15-6515/2016, ITB Warsaw.
- Hollow chipboard core and chipboard core have preparation for shortening as a standard.
- Size '110' is available only with hollow chipboard.
Glazing size is the same as for size '100'.
- Size '100' and '110' is not available for model 1.4.
- A rebated door is equipped with 3 PRIME hinges non-rebated with 2 3D hinges - hinges come with a door frame.
- Double doors are available in any door leaf size combinations.
- Passive door leaf (standard) is available for sizes from '60' to '100'.

- Passive door leaf (side panel) - sizes '30', '40', '50' is available only in flat option (without glazing or decorative mouldings). For non-rebated double door, 'active' and 'passive' door leaves must be ordered.
- Possibilities of ordering bespoke door models through Porta CONTRACT p. 226.
- Magnetic lock is not available for a double door.
- Size '80' and '90' in investment norm (clear opening width 800, 900 mm) available as a standard - without extra charge.
- Reinforcement for door closer requires third hinge.
- All of the stainless steel panels are available only for sizes: 80, 90, 100.

EXTRA CHARGES

- size '100' and '110'
- hollow chipboard core
- CPL finish 0,2 and 0,7 mm - GROUP II
- **OFFER** - PRIME set
- gold 3D hinges (an extra charge added to door frame price)
- third 3D hinge - silver (an extra charge added to door frame price)
- third 3D hinge - gold (an extra charge added to door frame price)
- ventilation grille (only group 1), ventilation sleeves or ventilation undercut
- magnetic lock
- preparation for shortening (maximum 60 mm) (group 1)
- reinforcement for door closer (third hinge is required)
- frosted/transparent glass - model 1.2
- frosted/transparent glass - model 1.3 and 1.4
- frosted/transparent glass - model 1.5
- frosted/transparent glass - models of group 5 (1PCs of glass)
- stainless steel porthole (model 1.1)
- push panel - both sides set (models 1.1, 1.2)
- kick panel both sides set (models 1.1, 1.2, 1.3)
- kick panel with a ventilation undercut - both sides set (models 1.1, 1.2, 1.3)
- ventilation kick panel - both sides set (models 1.1, 1.2, 1.3)
- hook lock with side pull handles (sliding doors)
- oblong pull handle for sliding doors
- caps for standard hinges (set for 1 pcs)
- handle with an escutcheon

(see p. 200)



Porta RESIST

TOP
COLLECTIONS

TOP
INVESTMENT
COLLECTIONS



WE RECOMMEND

Chosen models with a hollow core are classified with 3rd strength performance class. Additionally, available the 'investment set' containing 3 part hinges and a lock of the highest category of use (at an extra charge). The set consists of a door leaf and a dedicated door frame.

Porta RESIST 1.1, Halifax Natural

vertical graining:



Porta RESIST 7.1, Halifax Natural



model 1.1



model 1.2



model 1.3



model 1.4

horizontal graining:



model 7.1



model 7.2



model 7.3



model 7.4

vertical or horizontal graining:



model B.1*



model E.1*



model H.1*



model 4.A



model 4.B

* graining is in line with the direction of inlays

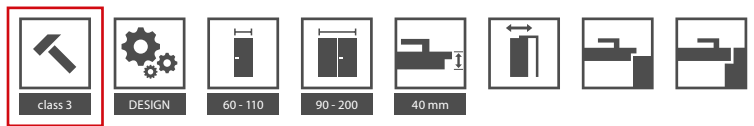

AVAILABLE FINISHES

Gladstone / Halifax ★★★★★



AN INNOVATIVE PRODUCT ON THE MARKET

Texture of Gladstone/Halifax finish resembles real raw wood.

K Check the possibilities of ordering bespoke door models through Porta CONTRACT, see page 226.

Gladstone/Halifax



EXTREME

High durability level which guarantees door protection from intensive usage. Indications for use - places with heavy foot traffic, where hundreds of people pass daily.

PORTA RESIST - INDICATIONS FOR USE:

- Offices
- Hotels and guesthouses
- Public buildings
- Residential buildings

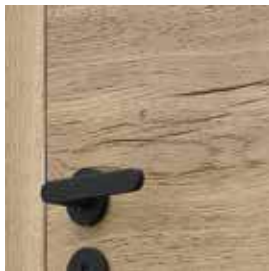

Gladstone / Halifax texture emphasizes natural wood rawness



black decorative inlay, silver ones also available srebrne

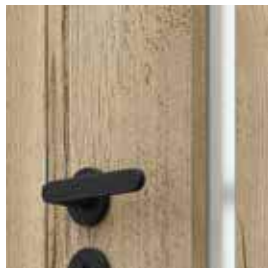

glazing - model 4.A

WE RECOMMEND!

The door leaf is skinned with a highly compressed board with very fine fibres structure. Thanks to its high density, the board guarantees resistance to impacts, attritions and scratches.



TECHNICAL INFORMATION

DOOR LEAF CONSTRUCTION

Honeycomb or hollow chipboard core (at an extra charge) reinforced with rails and stiles. Models 1.4, 1.7 - chipboard core, 4.B - hollow chipboard core. The construction is skinned with HDF, lipping ABS tape on the side edges. Inlays - black or silver, 6 mm wide. 4.A and 4.B models come with 8 mm thick, tempered glass, which is an element of the construction.

ACCESSORIES INCLUDED IN THE DOOR LEAF PRICE

- Two or three barrel hinges, PRIME set available ->see extra charges
- Three hinges for size '100' or '110'
- Lock: key lock, WC lock, or cylinder lock
- Glazing - models of gr. 1 and 7 'chinchilla' glass; frosted tempered glass; transparent glass. Models of gr. 4 - 8 mm thick frosted tempered glass.
- Round pull handle (for sliding doors)

DOOR FRAMES

Recommended rebated door frames:

- Porta SYSTEM see p. 178
- MINIMAX see p. 176
- STEEL see p. 190-195

Recommended non-rebated door frames:

- Porta SYSTEM ELEGANCE see p. 180

NOTES

- Technical Assessment AT-15-6515/2016, ITB Warsaw.
- A rebated door is equipped with 3 PRIME hinges non-rebated with 2 3D hinges - hinges come with a door frame.
- Ventilation grille, ventilation sleeves and preparation for shortening are not available for group 4.

- Hollow chipboard core and chipboard core have preparation for shortening as a standard.
- Size '100' and '110' is not available for model 1.4, 7.4.
- Size '110' is available only with hollow chipboard. Glazing size is the same as for size '100'.
- Size '110' is not available for models of gr. 4.
- Fixed size of glass, model 4.A.
- Magnetic lock is not available for a double door.
- Double doors are available in any door leaf size combinations. For non-rebated double door, 'active' and 'passive' door leaves must be ordered.
- Size '80' and '90' in investment norm (clear opening width 800, 900 mm) available as a standard (applies to gr. 1 and 7) - without extra charge.
- Reinforcement for door closer requires third hinge.

EXTRA CHARGES

- size '100' and '110'
- hollow chipboard core
- **OFFER** - PRIME set
- gold 3D hinges (an extra charge added to door frame price)
- third 3D hinge - silver (an extra charge added to door frame price)
- third 3D hinge - gold (an extra charge added to door frame price)
- ventilation grille (only group 1 and 7), ventilation sleeves or ventilation undercut
- magnetic lock
- preparation for shortening (maximum 60 mm) (apart from gr. 4)
- reinforcement for door closer (third hinge is required)
- stainless steel porthole (model 1.1, 7.1)
- hook lock with side pull handles (sliding doors)
- oblong pull handle for sliding doors
- caps for standard hinges (set for 1 PCs)
- handle with an escutcheon

(see p. 200)

Porta FOCUS



Porta FOCUS 4.A, Natural Walnut (matt)



Porta FOCUS 4.A, Natural Walnut (matt)



model 2.0



model 4.A



model 4.B

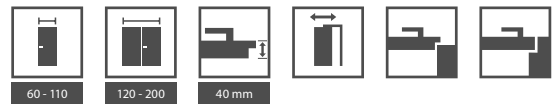

AVAILABLE FINISHES

Portadecor veneer ★★★★★☆

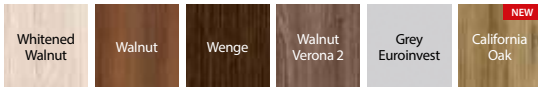

Portaperfect 3D veneer ★★★★★☆



Portaperfect 3D veneer ★★★★★☆



CPL HQ 0,2 veneer ★★★★★☆

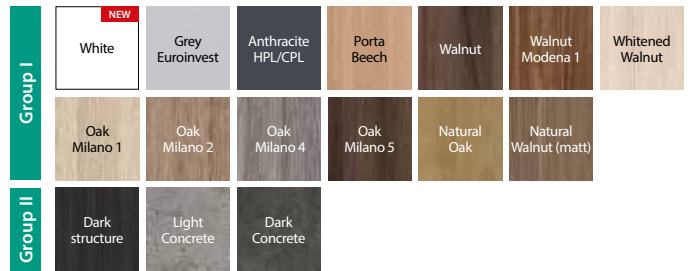

Portalamino ★★★★★☆

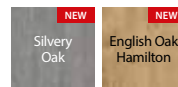

Porta FOCUS



glass-door panel joint rebated door



glass-door panel joint non-rebated door

TECHNICAL INFORMATION

DOOR LEAF CONSTRUCTION

Honeycomb or hollow chipboard core (at an extra charge) reinforced with rails and stiles. The construction is skinned with HDF. Glazed models come with 8 mm thick, frosted tempered panel glass, which is an element of the construction. There is lipping ABS on the side edges of the doors finished with CPL.

ACCESSORIES INCLUDED IN THE DOOR LEAF PRICE

- Two or three barrel hinges, PRIME set available ->see extra charges
- Three hinges for size '100' and '110'
- Lock: key lock, WC lock, or cylinder lock
- Frosted, tempered glass
- Round pull handle (for sliding doors)

DOOR FRAMES

Recommended rebated door frames:

- Porta SYSTEM see p. 178
- MINIMAX see p. 176
- STEEL see p. 190-195

Recommended non-rebated door frames:

- Porta SYSTEM ELEGANCE see p. 180
- LEVEL see p. 182

NOTES

- Technical Assessment AT-15-6515/2016, ITB Warsaw.
- Ventillation undercut in glazed models is available only for Polish Norm.
- Hollow chipboard core and chipboard core have preparation for shortening as a standard.
- Size '110' is available only with chipboard core.
- Double doors are available in any door leaf size combinations.
- For non-rebated double door, 'active' and 'passive' door leaves must be ordered.
- 4.B model is available only with hollow chipboard core, free of extra charge.
- Size '110' is not available for models of group 4.
- **Fixed size of glass - group 2, model 4.A.**
- Magnetic lock is not available for a double door.

EXTRA CHARGES

- size '100', '110'
- CPL finish 0,2 - GROUP II
- hollow chipboard core
- ventilation undercut or ventilation sleeves
- PRIME hinges (for dedicated door frames)
- PRIME lock with glossy faceplate (silver or gold)
- gold 3D hinges (an extra charge added to door frame price)
- third 3D hinge - silver (an extra charge added to door frame price)
- third 3D hinge - gold (an extra charge added to door frame price)
- magnetic lock
- hook lock with side pull handles (sliding doors)
- oblong pull handle for sliding doors
- caps for standard hinges (set for 1 pcs)
- handle with an escutcheon

(see p. 200)

Porta LOFT



Porta LOFT gives new possibilities of interior design. Timeless matt black colour is the leitmotiv of this collection. It is used to finish the door frame and all the accessories. Thanks to its combination with one of Porta's veneer you can create your own, unique, product that matches almost any interior.

Porta LOFT 1.1, Scandinavian Beech



Porta LOFT 1.1, Scandinavian Beech



model 1.1



model 4.A



model 4.B



model 1.1



model 4.A



model 4.B

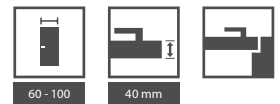

AVAILABLE FINISHES

Portaperfect 3D veneer ★★★★★☆



Gladstone / Halifax ★★★★★★



CPL HQ 0,2 veneer ★★★★★☆

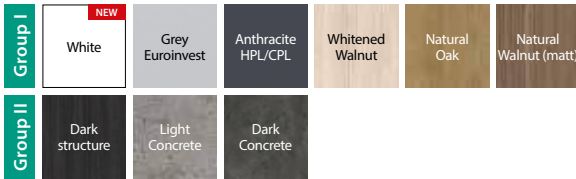

AVAILABLE FINISHES OF DOOR FRAMES

SUPER MATT veneer ★★★★★☆



CPL HQ 0,2 veneer ★★★★★☆



Porta LOFT



glass - door panel joint



3D hinges in door frame colour

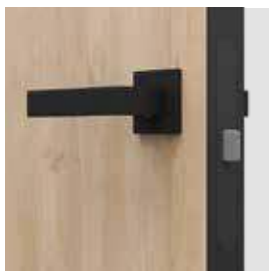

lock faceplate



lock faceplate

TECHNICAL INFORMATION

DOOR LEAF CONSTRUCTION

Honeycomb or hollow chipboard core (at an extra charge) reinforced with rails and stiles. The construction is skinned with HDF. Glazed models come with 8 mm thick, frosted tempered panel glass, which is an element of the construction. **The distinctive feature of this collection is black or white lipping ABS on the side edges.**

ACCESSORIES INCLUDED IN THE DOOR LEAF PRICE

- Two hidden hinges 3D, 3 hinges at an extra charge - door frame colour - Black or White
- Lock in ABS tape colour - Black or White
- 8 mm thick frosted, tempered glass

DOOR FRAMES

Recommended rebated door frames:

- Porta SYSTEM ELEGANCE black or white p. 180.

NOTES

- Technical Assessment AT-15-6515/2016, ITB Warsaw.
- Ventilation undercut in glazed models is available only for Polish Norm.
- Hollow chipboard core and chipboard core have preparation for shortening as a standard.
- 4.B model is available only with hollow chipboard core, free of extra charge.
- Fixed size of glass panel - model 4.A.
- Three hinges for size '100'.
- Non-rebated doors are equipped with two 3D hinges- hinges come with the door frame.

EXTRA CHARGES

- size '100'
- CPL finish 0,2 mm - GROUP II
- hollow chipboard core
- ventilation undercut
- third 3D hinge (an extra charge added to door frame price)
- preparation for shortening (maximum 60 mm), (group 1.1)
- handle with an escutcheon

(see p. 200)

NATURAL VENEER INTERIOR DOORS

Natural veneer doors are stylish and they emphasise good taste of the residents. The door leaf is covered with real wood which adds unusual charm and atmosphere to any interior.



**THEY SAY I'M VERY EMOTIONAL BUT
I'M JUST NOT ASHAMED OF MY FEELINGS.
I LIKE CUDDLES AND I LIKE COZY INTERIORS
SO I CHOOSE NATURAL VENEER DOORS.**





Nature CLASSIC

TOP
INVESTMENT
COLLECTIONS



WE RECOMMEND

Chosen models with a hollow core are classified with 3rd strength performance class. Additionally, available the 'investment set' containing 3 part hinges and a lock of the highest category of use (at an extra charge). The set consists of a door leaf and a dedicated door frame.

INVESTMENT LINE

Nature CLASSIC 1.1, Oak 1, grain '-flower' (produced through Porta CONTRACT see page 226).



Nature CLASSIC 1.1, Oak 1, grain '-flower'

HEIGHT 220

vertical graining:



model 1.1



model 1.1



model 1.2



model 1.3



model 1.4



model 5.1



model 5.2



model 5.3



model 5.4



model 5.5

horizontal graining:



model 7.1



model 7.2



model 7.3



model 7.4





AVAILABLE FINISHES

Natural Select Veneer ★★★★★☆



Natural veneer - Oak ★★★★★☆



Natural veneer - Ash ★★★★★☆



Ash veneer is available for models of group 1. Grain -,flower'.

Natural veneer - Walnut ★★★★★☆



Walnut veneer is available for models of group 1. Grain -,flower'.

Natural Satin Oak Veneer ★★★★★☆

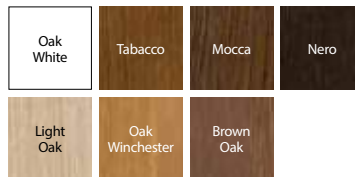

Customize colours to meet your individual needs. Send an enquiry through Porta CONTRACT. Details regarding bespoke order, see page 226.

Due to the characteristic of natural veneers, differences in colour and graining, might appear on a door leaf. These differences cannot be grounds for complaints.



horizontal graining group 7



fancy decorative moulding group 5

TECHNICAL INFORMATION

DOOR LEAF CONSTRUCTION

Core - stabilizing infill reinforced with rails and stiles. The construction is skinned with a slim particle board which is finished with high quality natural veneer. The door leaf surface is protected by ecological water-based varnishes. Select, Natural Oak, Ash, Walnut and Satin (apart from white) veneers are hardened under UV lamp (semi-matt). Hollow chipboard core available at an extra charge.

ACCESSORIES INCLUDED IN THE DOOR LEAF PRICE

- Lock with glossy faceplate (silver or gold): key lock, WC lock, or cylinder lock
- Glass panel - 'chinchilla' or frosted tempered glass
- Preparation for shortening (maximum 60 mm)
- Round pull handle (for sliding doors)

DOOR FRAMES

Recommended rebated door frames:

- Porta SYSTEM see p. 178
- MINIMAX see p. 176
- STEEL see p. 190-195

Recommended non-rebated door frames:

- Porta SYSTEM ELEGANCE see p. 180

NOTES

- Technical Assessment AT-15-6515/2016, ITB Warsaw.
- A rebated door is equipped with 3 PRIME hinges non-rebated with 2 3D hinges - hinges come with a door frame.
- **Height 220 - available for models 1.1 and 1.7 (non-rebated option)**
- Size '100' is not available for model 1.3
- Unvarnished door leaves are available at a standard product price
- Ventilation sleeves- silver or gold. 1 row.
- Double doors are available in any door leaf size combinations. For a double non-rebated door, 'active' and 'passive' door leaves must be ordered
- Magnetic lock is not available for a double door.

EXTRA CHARGES

- size '100'
- door leaf height 220 cm
- ventilation undercut or ventilation sleeves 1 row, 2 rows available only for models: 1.1, 1.2, 1.3
- stainless steel porthole (only 1.1, 1.2, 1.3 models)
- gold 3D hinges (an extra charge added to a door frame price)
- third 3D hinge - silver (an extra charge added to a door frame price)
- third 3D hinge - gold (an extra charge added to a door frame price)
- magnetic lock
- hook lock with side pull handles (sliding doors)
- an oblong pull handle for sliding doors
- mirror on one side
- mirror on both sides
- hollow chipboard core
- 'Satin white oak' finish
- a handle with an escutcheon

(see p. 200)



Nature LINE

TOP
INVESTMENT
COLLECTIONS



INVESTMENT LINE

Nature LINE E.2, Mocca

HEIGHT 220



Nature LINE F.1, Mocca



model F.1



model F.1



model A.1



model B.1



model C.2



model E.2



model G.1



model H.1





AVAILABLE FINISHES

Natural Select Veneer ★★★★★☆



Natural veneer - Oak ★★★★★☆



Natural Satin Oak Veneer ★★★★★☆

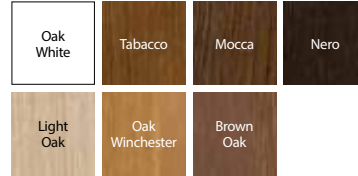

Due to the characteristic of natural veneers, differences in colour and graining, might appear on a door leaf. These differences cannot be grounds for complaints.



silver decorative inlay



silver decorative inlay

TECHNICAL INFORMATION

DOOR LEAF CONSTRUCTION

Core- stabilising infill reinforced with rails and stiles. The construction is skinned with slim particle board which is finished with high quality natural veneer. Door leaves are enriched with aluminium decorative inlays, 6 mm wide. The door leaf surface is protected by ecological water-based varnishes. Select, Natural Oak and Satin (apart from white) veneers are hardened under UV lamp (semi-matt). Hollow chipboard core available at an extra charge.

ACCESSORIES INCLUDED IN THE DOOR LEAF PRICE

- Lock with glossy faceplate (silver or gold): key lock, WC lock, or cylinder lock
- Preparation for shortening (maximum 60 mm)
- Round pull handle (for sliding doors)

DOOR FRAMES

Recommended rebated door frames:

- Porta SYSTEM see p. 178
- MINIMAX see p. 176
- STEEL see p. 190-195

Recommended non-rebated door frames:

- Porta SYSTEM ELEGANCE see p. 180

NOTES

- Technical Assessment AT-15-6515/2016, ITB Warsaw.
- A rebated door is equipped with 3 PRIME hinges non-rebated with 2 3D hinges - hinges come with a door frame.
- Height 220 - available for all non-rebated models
- Ventilation sleeves- silver or gold. 1 or rows
- Double doors are available in any door leaf size combinations.
- For a double non-rebated door, 'active' and 'passive' door leaves must be ordered
- Magnetic lock is not available for a double door

EXTRA CHARGES

- size '100'
- door leaf height 220 cm
- ventilation sleeves or ventilation undercut
- hook lock with side pull handles (sliding doors)
- an oblong pull handle for sliding doors
- gold 3D hinges (an extra charge added to a door frame price)
- third 3D hinge - silver (an extra charge added to a door frame price)
- third 3D hinge - gold (an extra charge added to a door frame price)
- magnetic lock
- hollow chipboard core
- White Oak -Satin finish
- a handle with an escutcheon

(see p. 200)



Nature VECTOR



NEW

Nature VECTOR collection - doors in natural veneer: White Oak Satin. The collection consists of the most frequently chosen decorative milling patterns of the Porta VECTOR collection and a new dedicated one - pattern J.

MODERN LINE

Nature VECTOR J, Oak White



Nature VECTOR J, Oak White



model B



model E



model J



model U



model V

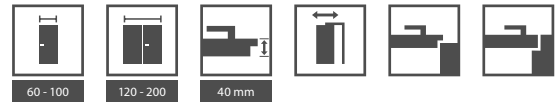

AVAILABLE FINISHES

Natural Satin Oak Veneer ★★★★★☆



K Give free rein to your imagination! Do you have your own door concept? You can order any milling with Porta CONTRACT, details regarding bespoke orders see page 226.



decorative milling close up - visible texture of Natural Oak

TECHNICAL INFORMATION

DOOR LEAF CONSTRUCTION

Core - stabilising infill reinforced with rails and stiles. The construction is skinned with a slim particle board which is finished with high quality natural veneer. The door leaf surface is protected by ecological water-based varnishes. Hollow chipboard core available at an extra charge.

ACCESSORIES INCLUDED IN THE DOOR LEAF PRICE

- Two or three PRIME hinges
- Three hinges for size '100'
- Lock with glossy faceplate (silver or gold): key lock, WC lock, or cylinder lock
- Round pull handle (for sliding doors)

DOOR FRAMES

Recommended rebated door frames:

- Porta SYSTEM see p. 178
- MINIMAX see p. 176
- STEEL see p. 190-195

Recommended non-rebated door frames:

- Porta SYSTEM ELEGANCE see p. 180

NOTES

- Technical Assessment AT-15-6515/2016, ITB Warsaw.
- A rebated door is equipped with 3 PRIME hinges non-rebated with 2 3D hinges - hinges come with a door frame.
- Double doors are available in any door leaf size combinations.
- Passive door leaf (panel) available in sizes: 30', 40', 50' - without a decorative milling
- Magnetic lock is not available for a double door
- Reinforcement for door closer requires third hinge

EXTRA CHARGES

- size '100'
- hollow chipboard core
- Ventilation sleeves or ventilation undercut
- preparation for shortening (maximum 60 mm)
- gold 3D hinges (an extra charge added to a door frame price)
- third 3D hinge - silver (an extra charge added to a door frame price)
- third 3D hinge - gold (an extra charge added to a door frame price)
- magnetic lock
- reinforcement for door closer (third hinge is required)
- hook lock with side pull handles (sliding doors)
- an oblong pull handle for sliding doors
- a handle with an escutcheon

(see p. 200)



Nature GRANDE



MODERN LINE

Nature GRANDE A.1, Oak



Nature GRANDE A.0, Oak



model A.0



model A.1



model B.0



model B.1



model B.3



model C.0



model C.1



model D.0



model D.1



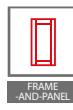

AVAILABLE FINISHES

Natural Select Veneer ★★★★★☆



Natural veneer - Oak ★★★★★☆



Natural Satin Oak Veneer ★★★★★☆

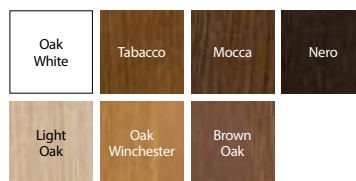

Due to the characteristic of natural veneers, differences in colour and graining, might appear on a door leaf. These differences cannot be grounds for complaints.

Nature GRANDE



a door with glazing



flat panel

TECHNICAL INFORMATION

DOOR LEAF CONSTRUCTION

Frame and panel construction. A door leaf is finished with natural veneer. Surface is protected by ecological water-based varnishes. Select, Natural Oak and Satin (apart from white) veneers are hardened under UV lamp (semi-matt)

ACCESSORIES INCLUDED IN THE DOOR LEAF PRICE

- Lock with glossy faceplate (silver or gold): key lock, WC lock, or cylinder lock
- Frosted tempered glass
- Preparation for shortening (maximum 60 mm)
- Round pull handle (for sliding doors)

DOOR FRAMES

Recommended rebated door frames:

- Porta SYSTEM see p. 178
- MINIMAX see p. 176

Recommended non-rebated door frames:

- Porta SYSTEM ELEGANCE see p. 180

NOTES

- Technical Assessment AT-15-6515/2016, ITB Warsaw.
- Double doors are available in any door leaf size combinations.
- A rebated door is equipped with 3 PRIME hinges non-rebated with 2 3D hinges - hinges come with a door frame.
- Magnetic lock is not available for a double door.

EXTRA CHARGES

- size '100'
- ventilation undercut
- preparation for shortening (maximum 60 mm)
- gold 3D hinges (an extra charge added to a door frame price)
- third 3D hinge - silver (an extra charge added to a door frame price)
- third 3D hinge - gold (an extra charge added to a door frame price)
- magnetic lock
- hook lock with side pull handles (sliding doors)
- an oblong pull handle for sliding doors
- White Oak -Satin finish
- a handle with an escutcheon

(see p. 200)



Nature IMPRESS, Nature SPACE



MODERN LINE

Nature IMPRESS 7, Brown Oak



Nature IMPRESS 4, Brown Oak



IMPRESS 1



IMPRESS 3



IMPRESS 4



IMPRESS 7



IMPRESS 8



IMPRESS 9



SPACE F.0



SPACE F.1



SPACE G.0



SPACE G.1



SPACE H.1





AVAILABLE FINISHES

Natural Select Veneer ★★★★★☆



Natural veneer - Oak ★★★★★☆



Natural Satin Oak Veneer ★★★★★☆

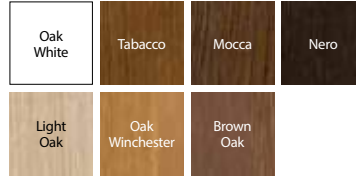

Due to the characteristic of natural veneers, differences in colour and graining, might appear on a door leaf. These differences cannot be grounds for complaints.



Nature IMPRESS - relief Ratan



Nature SPACE - relief Ratan

TECHNICAL INFORMATION

DOOR LEAF CONSTRUCTION IMPRESS

Hollow chipboard core reinforced with rails and stiles. The construction is skinned with a slim particle board which is finished with high quality natural veneer. The door leaf surface contains relief and it is protected by ecological water-based varnishes. Select, Natural Oak and Satin (apart from white) veneers are hardened under UV lamp (semi-matt).

DOOR LEAF CONSTRUCTION SPACE

Glued softwood. Depending on the model, door leaves contain rails and stiles finished with natural veneer or relief board (Ratan pattern). Thanks to applied technology, door leaf is very resistant to deformation. Surface is protected by ecological water-based varnishes. Select, Natural Oak and Satin (apart from white) veneers are hardened under UV lamp (semi-matt).

ACCESSORIES INCLUDED IN THE DOOR LEAF PRICE

- Lock with glossy faceplate (silver or gold): key lock, WC lock, or cylinder lock
- Preparation for shortening, maximum 60 mm (IMPRESS only models: 1, 3, 4, SPACE only models: F0, G0)
- Frosted tempered glass, 8 mm thick

DOOR FRAMES

Recommended rebated door frames:

- Porta SYSTEM see p. 178
- MINIMAX see p. 176
- STEEL see p. 190-195

Recommended non-rebated door frames:

- Porta SYSTEM ELEGANCE see p. 180

NOTES

- Technical Assessment AT-15-6515/2016, ITB Warsaw.
- A rebated door is equipped with 3 PRIME hinges non-rebated with 2 3D hinges - hinges come with a door frame.
- Ventilation sleeves- silver or gold. 1 row.
- Double doors are available in any door leaf size combinations.
- For a double non-rebated door, 'active' and 'passive' door leaves must be ordered
- Magnetic lock is not available for a double door.

EXTRA CHARGES

- size '100'
- ventilation sleeves or ventilation undercut (doesn't apply to glazed models)
- magnetic lock
- hook lock with side pull handles (sliding doors)
- an oblong pull handle for sliding doors
- gold 3D hinges (an extra charge added to a door frame price)
- third 3D hinge - silver (an extra charge added to a door frame price)
- third 3D hinge - gold (an extra charge added to a door frame price)
- 'Satin white oak' finish
- a handle with an escutcheon

(see p. 200)



Nature CONCEPT



Nature CONCEPT C.6, Oak

WE RECOMMEND

Traditional frame and panel construction guarantees long-time durability.

MODERN LINE



Nature CONCEPT C.6, Oak



model A.0



model A.3



model A.9



model B.0



model D.0



model C.0



model C.2



model C.4



model C.6



model K.0



model K.1



model K.2



model K.3

Check more models of this collection [on a website](#)



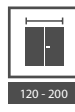
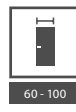

AVAILABLE FINISHES

Natural Select Veneer ★★★★★☆



Natural veneer - Oak ★★★★★☆



Natural Satin Oak Veneer ★★★★★☆

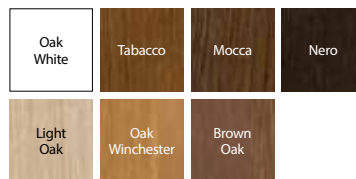

Due to the characteristic of natural veneers, differences in colour and graining, might appear on a door leaf. These differences cannot be grounds for complaints.



flat panel – model A.0



frosted glass panel – model A.9



flat panel – model B.0



decorative inlays – model D.0

TECHNICAL INFORMATION

DOOR LEAF CONSTRUCTION

Glued laminated with MDF. The construction is finished with natural veneer. Thanks to applied technology, door leaf is very resistant to deformations. Model D.0 - aluminium decorative inlays, 6 mm wide. Surface is protected by ecological water-based varnishes. Select, Natural Oak and Satin (apart from white) veneers are hardened under UV lamp (semi-matt).

ACCESSORIES INCLUDED IN THE DOOR LEAF PRICE

- Lock with glossy faceplate (silver or gold): key lock, WC lock, or cylinder lock
- Frosted tempered glass
- Preparation for shortening, maximum 60 mm
- Oblong pull handle (for sliding doors)

DOOR FRAMES

Recommended rebated door frames:

- Porta SYSTEM see p. 178
- MINIMAX see p. 176

Recommended non-rebated door frames:

- Porta SYSTEM ELEGANCE see p. 180

NOTES

- Technical Assessment AT-15-6515/2016, ITB Warsaw.
- A rebated door is equipped with 3 PRIME hinges non-rebated with 2 3D hinges - hinges come with a door frame.
- Ventilation sleeves- silver or gold. 1 row.
- Double doors are available in any door leaf size combinations. For a double non-rebated door, 'active' and 'passive' door leaves must be ordered.
- Magnetic lock is not available for a double door.

EXTRA CHARGES

- size '100'
- ventilation sleeves or ventilation undercut
- hook lock with side pull handles (sliding doors)
- an oblong pull handle for sliding doors
- gold 3D hinges (an extra charge added to a door frame price)
- third 3D hinge - silver (an extra charge added to a door frame price)
- third 3D hinge - gold (an extra charge added to a door frame price)
- magnetic lock
- 'Satin white oak' finish
- a handle with an escutcheon

(see p. 200)



MADRID, CORDOBA, TOLEDO



CLASSIC LINE

CORDOBA large muntin, panel K Tabacco



CORDOBA solid, Tabacco



MADRID solid



MADRID small glazing



MADRID muntin



MADRID large muntin



CORDOBA solid



CORDOBA small glazing



CORDOBA muntin



CORDOBA large muntin



side panel A



side panel K



TOLEDO solid



TOLEDO model 1



TOLEDO model 2



TOLEDO model 3



TOLEDO model 5





AVAILABLE FINISHES

Natural veneer - Oak ★★★★★☆



Due to the characteristic of natural veneers, differences in colour and graining, might appear on a door leaf. These differences cannot be grounds for complaints.

Natural Satin Oak Veneer ★★★★★☆

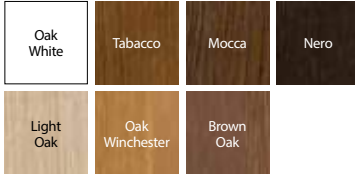

MADRID,
CORDOBA,
TOLEDO



MADRID
decorative profiled rails and stiles



CORDOBA
minimalist rails and stiles chamfered with 20°



MADRID
decorative covered panel



TOLEDO
minimalist rails and stiles chamfered with 20°

TECHNICAL INFORMATION

DOOR LEAF CONSTRUCTION

Glued softwood with MDF. The construction is finished with natural veneer. Thanks to applied technology, door leaf is very resistant to deformations. Surface is protected by ecological water-based varnishes. Natural Oak and Satin (apart from white) veneers are hardened under UV lamp (semi-matt). Rails and stiles of Cordoba and Toledo are chamfered with 20°.

ACCESSORIES INCLUDED IN THE DOOR LEAF PRICE

- Lock with glossy faceplate (silver or gold): key lock, WC lock, or cylinder lock
- Glass panels - 'chinchilla' or frosted tempered glass preparation for shortening, maximum 60 mm. A door leaf with a ventilation slit - shortening up to 40 mm
- Round pull handle (for sliding doors)
- A seal fitting the glass panel

DOOR FRAMES

Recommended rebated door frames:

- Porta SYSTEM see p. 178
- MINIMAX see p. 176

Recommended non-rebated door frames:

- Porta SYSTEM ELEGANCE see p. 180

NOTES

- Technical Assessment AT-15-6515/2016, ITB Warsaw.
- A rebated door is equipped with 3 PRIME hinges non-rebated with 2 3D hinges - hinges come with a door frame.
- Unvarnished door leaves are available at standard product price
- Ventilation sleeves- silver or gold. 1 row.
- Double doors are available in any door leaf size combinations.
- For a double non-rebated door, 'active' and 'passive' door leaves must be ordered
- Magnetic lock is not available for a double door
- Side panels in size '40'

EXTRA CHARGES

- size '100'
- ventilation sleeves or ventilation undercut
- hook lock with side pull handles (sliding doors)
- an oblong pull handle for sliding doors
- gold 3D hinges (an extra charge added to a door frame price)
- third 3D hinge - silver (an extra charge added to a door frame price)
- third 3D hinge - gold (an extra charge added to a door frame price)
- magnetic lock
-  an astragal for double doors
- White Oak -Satin finish
- a handle with an escutcheon

(see p. 200)



Villadora RETRO



PREMIUM LINE

Villadora RETRO, Residence 0, Module RETRO, White Oak



Villadora RETRO Residence 0, Oak White



Capital 0

Capital 1

Residence 0

Residence 2



Delarte 0

Delarte 1

Delarte 2

Delarte 3



Empire 0

Empire 1



AVAILABLE FINISHES

Natural Satin Oak Veneer ★★★★★☆



Due to the characteristic of natural veneers, differences in colour and graining, might appear on a door leaf. These differences cannot be grounds for complaints.



decorative moulding with a raised panel



decorative glass panel Villadora A



decorative glass panel Villadora B

TECHNICAL INFORMATION

DOOR LEAF CONSTRUCTION

Frame and panel construction. Rails and stiles made of high quality softwood and wood-based materials, finished with Natural Oak veneer. Specially selected satin tempered glass. Decorative mouldings/beads made of solid oak. The door leaf surface is protected by ecological water-based varnishes.

ACCESSORIES INCLUDED IN THE DOOR LEAF PRICE

- Lock with glossy faceplate (silver or gold): key lock, WC lock, or cylinder lock
- Plain satin glass, pattern A and B (an option for models: Empire, Capital, Delarte)
- Preparation for shortening (maximum 60 mm)

DOOR FRAMES

Recommended rebated door frame:

- Villadora RETRO see p. 186

NOTES

- Technical Assessment AT-15-6515/2016, ITB Warsaw.
- Doors are equipped with 3 PCs of golden hinges – hinges packed with a frame Option of purchasing caps for hinges in a few colours: glossy golden, old gold, glossy silver- see extra charges
- Double doors are available in any door leaf size combinations.
- Magnetic lock is not available for a double door

EXTRA CHARGES

- ventilation sleeves 1 row
- magnetic lock
- ventilation undercut, ventilation slit
- caps for Villadora hinges
- handle with an escutcheon

(see p. 200)



Villadora MODERN



PREMIUM LINE

Villadora MODERN, Space S01, Walnut



Villadora MODERN, Space S01, Walnut

HEIGHT 220

horizontal grain:



Sand



Sand



Sand S01



Sand S02



Sand S03

vertical graining:



Space



Space S01



Space S02



Space S03



Line



Ethno

see details www.porta.com.pl/dm/villadora.pdf



AVAILABLE FINISHES

Natural Select Veneer ★★★★★☆



Natural veneer - Oak ★★★★★☆



Natural veneer - Ash ★★★★★☆



Ash veneer is available for models of group 1. Grain -,flower'.

Natural veneer - Walnut ★★★★★☆



Walnut veneer is available for models of group 1. Grain -,flower'.

Natural Satin Oak Veneer ★★★★★☆

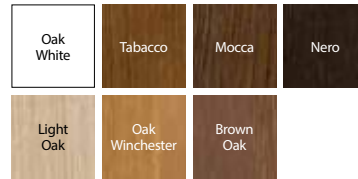

Due to the characteristic of natural veneers, differences in colour and graining, might appear on a door leaf. These differences cannot be grounds for complaints.

K Made to measure dimensions through Porta CONTRACT, see page 226.



model Line - grain

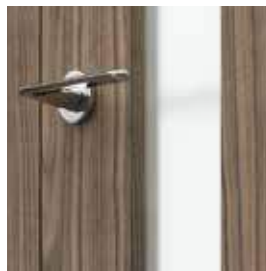

model Space - glazing



new 3D hidden hinge

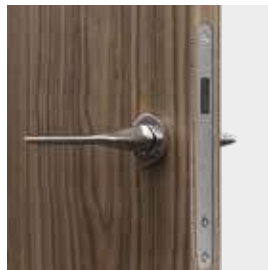

safe magnetic lock

TECHNICAL INFORMATION

DOOR LEAF CONSTRUCTION

Frame made of high quality wood, plywood and hollow chipboard, all skinned with a slim particle board, finished with natural veneer. 8 mm thick glass panel. The door leaf surface is protected by ecological water-based varnishes. Select, Natural Oak, Ash, Walnut and Satin (apart from white) veneers are hardened under UV lamp (semi-matt).

ACCESSORIES INCLUDED IN THE DOOR LEAF PRICE

- Lock with glossy faceplate (silver or gold): key lock, WC lock, or cylinder lock
- Key lock or magnetic lock
- Satin or transparent glass panel

DOOR FRAMES

Recommended non-rebated door frames:

- Villadora MODERN see p. 186

NOTES

- Technical Assessment AT-15-6515/2016, ITB Warsaw.
- Doors are equipped with 3 PCs of 3D hinges – hinges packed with a door frame
- Double doors are available in any door leaf size combinations.
- Magnetic lock is not available for a double door

EXTRA CHARGES

- ventilation sleeves 1 row
- ventilation shortening 12 mm (optional)
- magnetic lock (optional)
- 'Satin white oak' finish
- door leaf height 220 cm
- a handle with an escutcheon

(see p. 200)

FOLDING AND SLIDING DOORS

Sliding door collection meets the need of custom solutions in the home space. And most importantly - they match various models from the catalogue.



I OFTEN HEAR THAT I ALWAYS GET MY OWN WAY BUT I JUST KNOW WHAT I WANT. THAT'S WHY I HAVE CHOSEN DOORS WHICH EMPHASIZE THE CHARACTER OF THE SPACE I FEEL GOOD IN.



Folding doors



ALFA, BETA, White

ALFA



HOW TO OPEN THE DOOR* (top view)

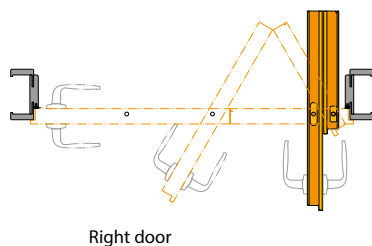

Right door

A REBATED DOOR LEAF

The complete set consists of:

- track system
- two-part door leaf
- Porta SYSTEM door frame (modified)



See the ALFA door
www.porta.com.pl/dm/alfabeta.wmv

BETA



HOW TO OPEN THE DOOR* (top view)

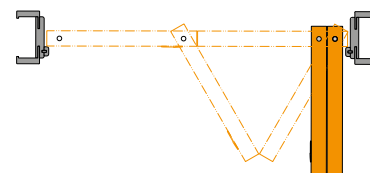

Right door

A NON-REBATED DOOR LEAF

The complete set consists of:

- track system
- two-part door leaf
- Porta SYSTEM door frame (modified)



See the BETA door
www.porta.com.pl/dm/alfabeta.wmv

*NOTE: Due to fittings specifics there is a slight narrowing of clear opening width when the door is open. (about 10 cm).

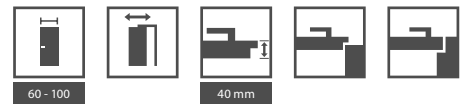

AVAILABLE FINISHES

Standard paint ★★★★★☆



Portadecor veneer ★★★★★☆

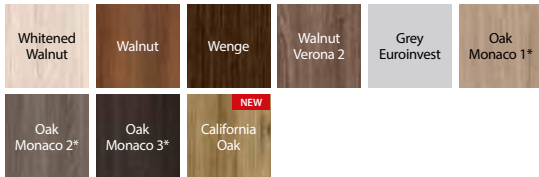

* until stocks last

Portaperfect 3D veneer ★★★★★☆

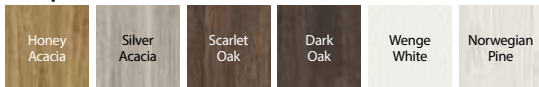

Portaperfect 3D veneer ★★★★★☆

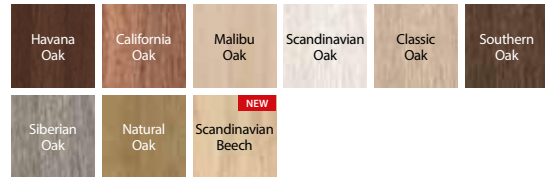

CPL HQ 0,2 veneer ★★★★★☆

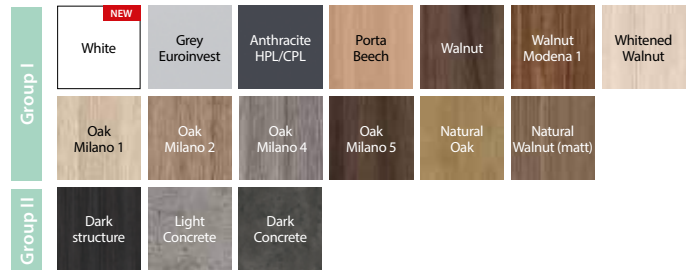

ALFA, BETA



how to open / fold ALFA door leaves



how to open / fold BETA door leaves

TECHNICAL INFORMATION

DOOR LEAF CONSTRUCTION

Honeycomb core or hollow chipboard core (at an extra charge) reinforced with plywood rails and stiles. Alfa – a two-part door, unsymmetrically divided, with a standard lock in a door leaf and a tongue strike in a door frame. Beta – a two part door, symmetrically divided without a lock.

ACCESSORIES INCLUDED IN THE PRICE

- Track
- Seal
- Three silver hidden hinges
- Lock: key lock, WC lock, cylinder lock (ALFA)
- Tongue strike (ALFA)
- Round pull handle (BETA)

DOOR FRAMES

- Modified Porta SYSTEM, adjustment range from B to K see p. 178.

NOTES

- National Technical Assessment ITB-KOT-2017/0184 issue 1
- Size '100' is not available for BETA.

EXTRA CHARGES

- size '100' (ALFA only)
- hollow chipboard core
- door leaf: CPL 0,2 mm finish - GROUP II
- door frame: CPL 0,2 mm finish - GROUP II
- ventilation sleeves, ventilation undercut
- price of ALFA track (extra charge to the set)
- a handle with an escutcheon

(see p. 200)

Sliding systems



Sliding system PORTA, Porta CONCEPT, A.9, Grey Euroinvest

ON WALL-MOUNTED SLIDING SYSTEMS

PORTA



The complete set consists of:

- on wall-mounted sliding system (track)
- a door leaf (sliding version)
- a door frame to suit on wall sliding system (tunnel version)

ALU

NEW



The set consists of:

- on wall-mounted sliding system (track)
- a door leaf (sliding version)
- a door frame to suit on wall sliding system (tunnel version)



AVAILABLE FINISHES

Portadecor ★★★
Portasynchro 3D

Portadur ★★★★★
Premium veneer
Natural Select
Natural Oak
Natural Oak Satin

Portaperfect 3D ★★★★★
CPL HQ
Gladstone/Halifax

Finishes charts see page 217 – 224.

NOTE! Any sliding version door leaf is compatible with System Porta and ALU.

TECHNICAL INFORMATION

System PORTA

CONSTRUCTION OF PORTA SLIDING SYSTEM

On Wall Sliding system consists of: a rail bar with trolleys, rail cover & door stop. Rail cover and a door stop are made of chipboard and MDF. If you decide to choose Natural Veneer for your Door, this will be finished with semi-matt varnish.

ACCESSORIES INCLUDED IN THE PRICE

- A rail with trolleys
- A lock strike
- Self-adhesive brush seal
- Guide element which stabilizes the door leaf. Floor-mounted.

DOOR FRAMES

- Porta SYSTEM door frame, 'tunnel' option see p. 178.
- Dimensions see page 211, Table 7.

NOTES

- National Technical Assessment ITB-KOT-2017/0184 edition 1.
- **Set is reversible (left/right). Opening direction can be changed by installing door stop (jamb) on right or left side of Porta System tunnel.**

EXTRA CHARGES

- CPL 0,2 mm finishes - GROUP II
- Natural veneer finish - White Oak Satin

System ALU

CONSTRUCTION OF ALU SLIDING SYSTEM

Offered system consists of: a rail and a construction profile supporting the door leaf. Both elements are made of nicely looking aluminium.

ACCESSORIES INCLUDED IN THE PRICE

- Guide element which stabilizes the door leaf. Floor-mounted.

DOOR FRAMES

- Porta SYSTEM frame 'tunnel', see dimensions see page 213, Table 7.

NOTES

- Set is reversible (left/right).
- In order to assemble the track system, a door leaf and a 'tunnel' door frame correctly, door leaf must be one size bigger. E.g track system and 'tunnel' size '70' goes with door leaf '80', track system and 'tunnel' '80' goes with a door leaf '90', '150' --> 2x '80', '170' --> 2x '90' etc,
- Hook lock is not available.

Sliding systems



Sliding system COMPACT, Porta CONCEPT A.9, Scandinavian Oak

The set consists of:

- a 'tunnel frame', dedicated for a wall -125 mm thick
- galvanized steel pocket dedicated for a wall -125 mm thick
- a door leaf - sliding option (not included in the price of COMPACT system).

POCKET DOOR SYSTEM

COMPACT

HOW TO OPEN THE DOOR (top view)

Discreet framework for installation in a plasterboard wall gives an opportunity to have a door in interiors, where a traditional hinged door would spoil design concept or would be even impossible to install.

Pocket door system COMPACT (tunnel' frame, metal cassette (pocket) dedicated for a wall 125 mm thick)

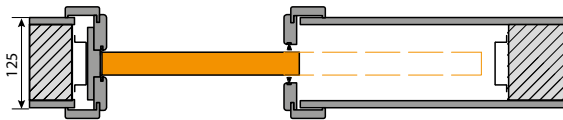

COMPACT,tunnel' frames are dedicated for wall thicknesses 100 mm and 150 mm.

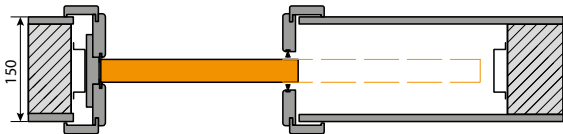
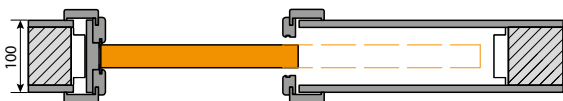

NOTE! Porta Compact tunnel frame is dedicated to work together with Porta pockets and pockets of leading European producers. Before installing Compact tunnel frame along with a pocket not produced by PORTA, it is required to check So/Ho dimensions.

WALL-MOUNTED SLIDING SYSTEM

METAL

HOW TO OPEN THE DOOR (top view)

Steel sliding system works in pair with all internal door leaves (sliding option). Recommended for interiors where design concept or limited space doesn't let to install traditional hinged doors.

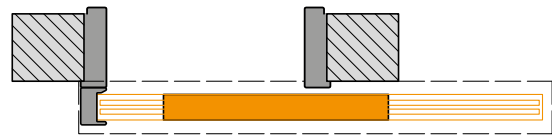

on wall-mounted sliding system METAL



hook lock
COMPACT sliding system



metal cassette (pocket)
COMPACT sliding system

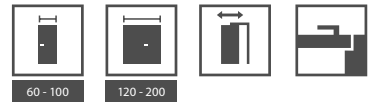

SLIDING SYSTEM 'COMPACT' - AVAILABLE FINISHES

Portadecor Portasynchro 3D	★★★
Portadur Premium veneer	★★★★
Portaperfect 3D CPL HQ Gladstone/Halifax	★★★★★

Finishes charts, see page 217 – 224.



Possibility of ordering 'tunnel' in natural veneer through Porta CONTRACT, see page 226.

SLIDING SYSTEM 'METAL' - AVAILABLE FINISHES

Polyester Premium Paint	★★★★★
-------------------------	-------

NOTE! Any sliding version door leaf is compatible with Compact and Metal systems.

TECHNICAL INFORMATION

COMPACT System

COMPACT SYSTEM CONSTRUCTION

Offered system for a 125 mm thick wall, consists of: a 'tunnel frame' made of chipboard and MDF; galvanized steel cassette with a running track, which are a pocket construction inside the wall.

ACCESSORIES IN THE COMPACT SYSTEM PRICE

- Pocket is dedicated for a wall -125 mm thick
- Rail with trolleys and a floor-mounted element which guides the door leaf
- Hook lock strike (optionally, at an extra charge)
- Anti-dust brush seal. Pressed in.
- 'Tunnel' for a wall 125 mm thick

DOOR FRAMES

- Door frames - 'tunnel' option. Available for wall thicknesses: 100 mm, 125 mm and 150 mm
- 'Tunnel' door frame dedicated for a wall thickness 125 mm is compatible with the PORTA pocket
- All of above mentioned 'tunnel frames' are compatible with pockets of leading European producers (H₀/S₀ dimensions must be checked)
- COMPACT, dimensions see page 213, Table 7.

NOTES

- Pocket system is dedicated for 125 mm thick plasterboard walls.
- It is possible to order additional extensions for symmetrical and unsymmetrical 'tunnel frames' (bespoke order).

EXTRA CHARGES

- coordination kit for a double door (open/close)
- CPL 0,2 mm finish - GROUP II

METAL System

METAL SYSTEM CONSTRUCTION

Complete set consists of: Corner profile folding frame (LARGE) dedicated for wall thickness 100 mm (tunnel option - without hinges, strike, and a seal bent), a rail with trolleys, rail cover and door stop (jamb). All of these elements are made of galvanized steel and packed ready for self-assembly on site.

ACCESSORIES IN THE ALU SYSTEM PRICE

- self-adhesive brush seal
- floor-mounted guiding and stabilizing element

DOOR FRAMES

- Folding steel door frame in 'tunnel' version. Sizes: '60', '70', '80', '90', '100' - see dimensions see page 213, Table 7.
- Set is reversible (left/right). Install at finished floor level.
- Opening direction can be changed by assembling door stop (jamb) on right or left side of Porta System tunnel.

NOTES

- National Technical Assessment ITB-KOT-2017/0184 issue 1.

EXTRA CHARGES

- finishes - GROUP II
- dowel pins

Sliding systems



Sliding system BLACK, type REA

BLACK



REA type



LUNA type



model 1



model 2



model 3

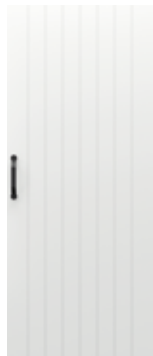

model 4

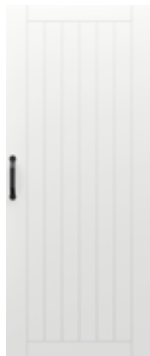

model 5

SLIDE



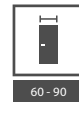

AVAILABLE FINISHES

BLACK System

Premium paint ★★★★★☆



UV acrylic paint ★★★★★☆



SLIDE System

Gladstone / Halifax ★★★★★★



Portaperfect 3D veneer ★★★★★☆

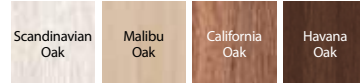

pull BLACK 1

TECHNICAL INFORMATION

System BLACK

DOOR LEAF CONSTRUCTION

Honeycomb or hollow chipboard core. The construction is skinned with HDF.

ACCESSORIES INCLUDED IN THE PRICE

- Track 2000 mm

NOTES

- Technical Assessment AT 15-6515/2016
- Set is reversible (left/right)
- Set is dedicated to be mounted on wall opening one size smaller than standard. See details see p. 213.
- Hook lock is not available.

EXTRA CHARGES

- Hollow chipboard core
- an oblong pull
- Black 1 pull
- A set of two Soft-Closes with Anti-Slam

System SLIDE

DOOR LEAF CONSTRUCTION

Honeycomb or hollow chipboard core. The construction is skinned with HDF.

ACCESSORIES INCLUDED IN THE PRICE

- Track 2000 mm
- A set of two Soft-Closes with Anti-Slam

NOTES

- Technical Assessment AT 15-6515/2016
- Set is reversible (left/right)
- Set is dedicated to be mounted on wall opening one size smaller than standard. See details 7 na see p. 213.
- Hook lock is not available.

EXTRA CHARGES

- an oblong pull

TECHNICAL DOORS

In this section we present products well known on investment projects.

We offer acoustic doors, specialized doors and also fire-resistant doors.



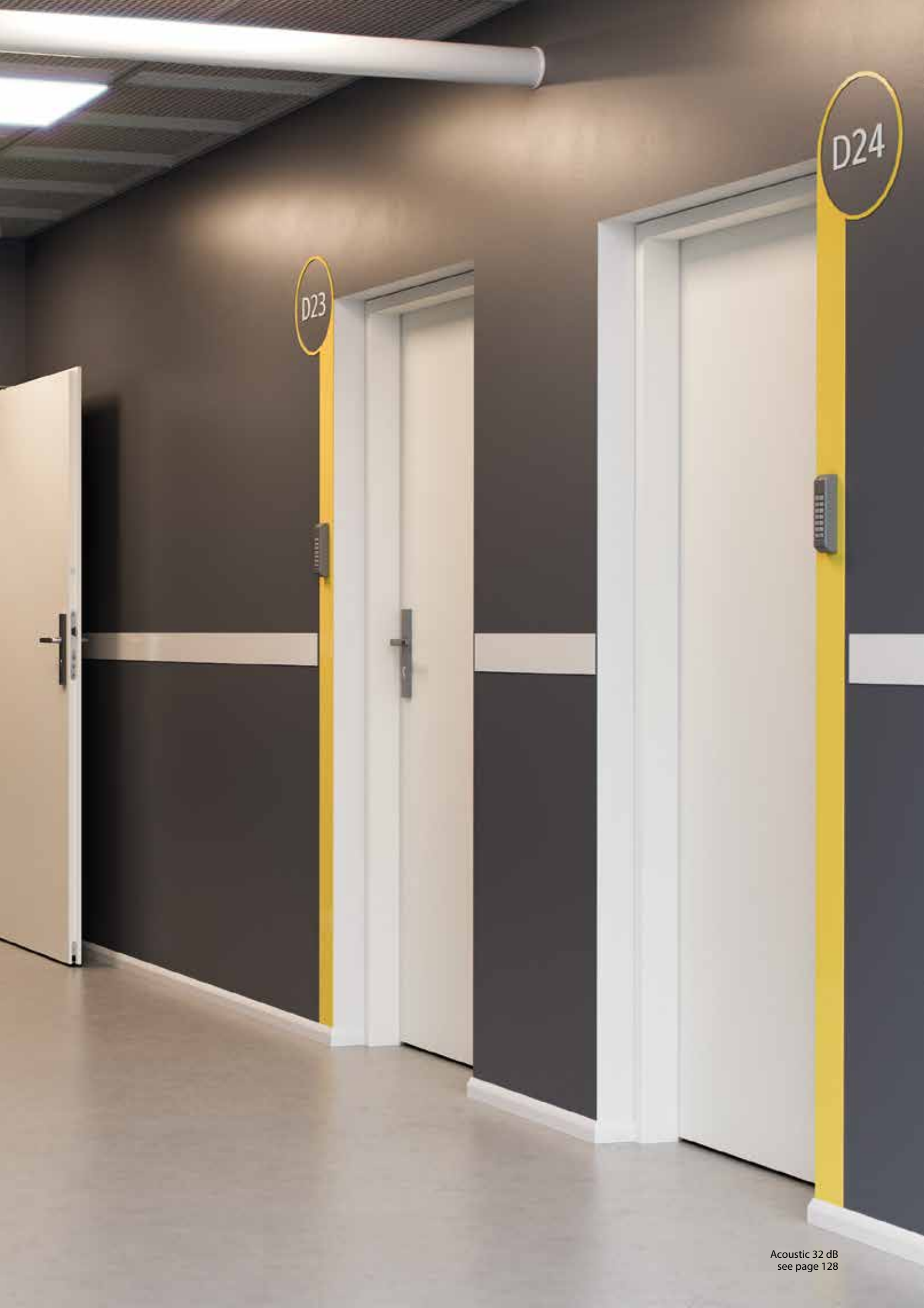

D23

D24

Acoustic 27 dB, 32 dB



Acoustic 32 dB, White

Acoustic rating:

Rw=31 dB*

Rw=35 dB*

All available models -see page 142



Flush model, White

ACOUSTIC RATING OF THE DOORS:

- Rw=27 dB (27-31 dB)
- Rw=32 dB (32-36 dB)



cylinder lock



automatic threshold seal



Three-part hinge

Rw 27dB
D_i 25Rw 32dB
D_i 30

PROJECT

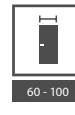

60 - 100



40-41 mm



44-45 mm



AVAILABLE FINISHES

Natural Select ★★★★★
Natural Oak, Ash, Walnut
Natural Oak Satin

CPL HQ 0,2 mm ★★★★★

CPL HQ 0,7 mm ★★★★★
Gladstone/Halifax

Finishes charts see page 217 – 224.

NOTE! Natural veneers (except Ash and Walnut) are available in vertical or horizontal grain direction (applies only to door leaf)

NOTE! It is recommended to choose CPL or Gladstone/Halifax laminate for entrance door, especially if they are used in public buildings.

27 dB, 32 dB

TECHNICAL INFORMATION

ACCESSORIES

- Three barrel hinges (adjustable door frame Porta system) or three-part hinges (steel door frame)
- Cylinder lock
- An automatic threshold seal
- A door frame seal
- A door frame
- A door leaf finished with CPL HQ or Gladstone/Halifax has lipping ABS on the side edges.

DOOR FRAMES

- Porta SYSTEM adjustable door frame (27dB door) 178.
- Reinforced Porta SYSTEM adjustable door frame (32dB door),
- Corner steel door frame of 100mm wide profile
- PROJECT BIS, PROJECT PREMIUM door frame cover. 196).

NOTES

- Technical Assessment ITB-KOT-2017/0096 issue 1 (Rw=27dB)
- Technical Assessment ITB-KOT-2017/0007 issue 1 (Rw=32dB)
- Acoustic rating Rw=27dB (27÷31 dB) D_i=25 dB
- Acoustic rating Rw=32dB (32÷36 dB) D_i=30dB
- Minimum width of door leaves with mouldings: moulding 1 – 444 mm, moulding 2 – 644 mm, moulding 3 – 468 mm, moulding 4 – 744 mm.
- Size '60' available for flush doors only (without decorative mouldings etc.)

EXTRA CHARGES

- size '100'
- adjustable strike (steel door frame)
- door leaf: colours of CPL 0,2 mm and 0,7 mm veneers– GROUP II
- door frame: colours of CPL 0,2 mm veneer– GROUP II
- door leaf: Gladstone/Halifax colours with vertical grains
- inlays in synthetic veneers (for 1 side, for both sides – price x 2)
- inlays in natural veneers (for 1 side, for both sides – price x 2)
- door leaf: Natural veneer, White Oak, Satin
- door leaf: Natural veneer, Oak, Satin (other colours)
- door leaf: Natural veneer: Walnut
- door frame: Natural veneer, White Oak, Satin
- door frame: Natural veneer, Oak, Satin (other colours)
- door frame: Natural veneer: Walnut
- steel door frame: colours - GROUP II
- steel door frame profile for PROJECT BIS cover
- steel door frame profile for PROJECT PREMIUM cover
- steel door frame profile from 101 to 150 mm
- steel door frame profile from 151 to 270 mm
- steel door frame profile from 271 to 390 mm
- reinforcement for a door closer (steel door frame)
- dowel pins (steel door frame)
- mounting anchors (steel door frame)
- a handle with an escutcheon

(see p. 203)

SILENCE 37 dB, EI 30

TOP
INVESTMENT
COLLECTIONS



Acoustic rating $R_w=40$ dB*
Fire resistance 30 min.
Smoke control.

SILENCE, Oak Milano 5

All available models -see page 142

ACOUSTIC RATING OF PORTA SILENCE DOOR:

- $R_w=37$ dB (37-41 dB)



Solid, Oak Milano 5 with an adjustable door frame



cylinder lock



heavy duty technical hinges



automatic threshold seal

Detailed tests results are available on our website tab DOWNLOAD on www.porta.com.pl

DETAILED OFFER IS ALSO AVAILABLE ON www.portadoors.com



AVAILABLE FINISHES

Natural Select ★★★★★
 Natural Oak, Ash, Walnut
 Natural Oak Satin

CPL HQ 0,2 mm ★★★★★

CPL HQ 0,7 mm ★★★★★
 Gladstone/Halifax

Finishes charts see page 217 – 224.

NOTE! Natural veneers (except Ash and Walnut) are available in vertical or horizontal grain direction (applies only to door leaf)

NOTE! It is recommended to choose CPL or Gladstone/Halifax laminate for entrance door, especially if they are used in public buildings.

SILENCE 37 dB

TECHNICAL INFORMATION

DOOR LEAF CONSTRUCTION

PortaSilence®core ia a special 5-layered sound proofing construction with rails and stiles made of glued laminated softwood. The construction is skinned with HDF. Available in rebated and non-rebated options. A door leaf finished with CPL HQ or Gladstone/Halifax has lipping ABS on the side edges.

ACCESSORIES

- Two or three heavy duty technical hinges
- Rebated version of MDF door frame – 4 barrel hinges
- Lock of the highest category of use - class 3 according to PN-EN 12209
- Automatic threshold seal

DOOR FRAMES

- A possibility of ordering a door frame in 2 options: rebated and non-rebated:
- Porta SYSTEM adjustable door frame for a wall thickness range from 120 to 300 mm. Made of plywood.
- Corner steel door frame of 100mm wide profile. Made of steel sheet, galvanized on both sides, 1,5 mm thick.
- 100 mm MDF fixed door frame.
- PROJECT BIS door frame (see p. 196).
- Available with Individual Approval Documentation covered by Contracts department

NOTES

- Technical Assessment ITB-KOT-2017/0007 issue 1.
- National certification of constancy of performance No 020-UWB-0567/W
- In order to meet the requirements of building law, regarding fire-rating and sound-proofness, it is necessary to use door closer.

- Fire rated doors should be equipped with escutcheon with a steel core handle
- In case of using different hardware to offered by PORTA, guarantee cards guidelines must be followed
- Available options: flat, with decorative inlays and with decorative slats.
- Fire rated doors – inlays available only in both sides option.

EXTRA CHARGES

- size '100'
- door leaf: colours of CPL 0,2 mm and 0,7 mm veneers– GROUP II
- door frame: colours of CPL 0,2 mm veneer– GROUP II
- door leaf: Gladstone/Halifax colours with vertical grains
- inlays in synthetic veneers (for 1 side, for both sides – price x 2)
- inlays in natural veneers (for 1 side, for both sides – price x 2)
- door leaf: Natural Satin Oak White veneer
- door leaf: Natural Satin Oak veneer (other colours)
- door leaf: Natural Walnut veneer
- door frame: Natural Satin Oak White veneer
- door frame: Natural Satin Oak veneer (other colours)
- door frame: Natural Walnut veneer
- steel door frame: colours - GROUP II
- steel door frame profile for PROJECT BIS cover
- steel door frame profile from 101 to 150 mm
- steel door frame profile from 151 to 270 mm
- steel door frame profile from 271 to 390 mm
- handle with escutcheon

(see p. 203)

Acoustic 42 dB



Acoustic 42 dB, Natural Walnut (matt)

Acoustic rating $R_w=43$ dB*

All available models -see page 142



Solid, Natural Walnut (matt)

ACOUSTIC RATING:

- $R_w=42$ dB (42–46 dB)



cylinder lock

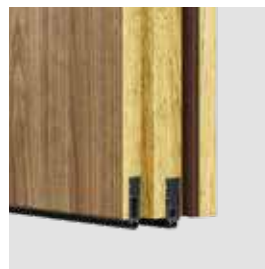

two automatic threshold seals
(option with Porta System door frame)



heavy duty technical hinges

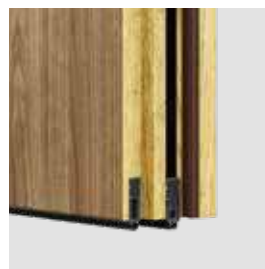

two automatic threshold seals
(option with steel door frame
and MDF door frame)

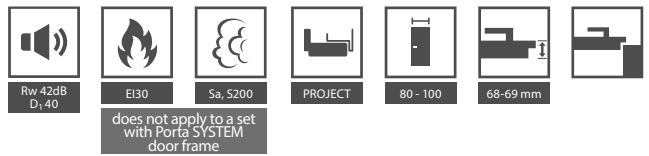

AVAILABLE FINISHES

Natural Select ★★★★★
 Natural Oak, Ash, Walnut
 Natural Oak Satin

CPL HQ 0,2 mm ★★★★★

CPL HQ 0,7 mm ★★★★★
 Gladstone/Halifax

Finishes charts see page 217 – 224.

NOTE! Natural veneers (except Ash and Walnut) are available in vertical or horizontal grain direction (applies only to door leaf)

NOTE! It is recommended to choose CPL or Gladstone/Halifax laminate for entrance door, especially if they are used in public buildings.

42 dB

TECHNICAL INFORMATION

ACCESSORIES

- Two heavy duty technical hinges, three hinges for MDF (EI 30) door frame
- Lock of the highest category of use - class 3 according to PN-EN 12209
- Two automatic threshold seals
 - rubber seal set circumferentially in door leaf and door frame rebates
 - intumescent strip (under high temperatures) - EI 30, Rw=42 Db option

DOOR FRAMES

- Reinforced adjustable Porta SYSTEM door frame TYPE DT-AW/PS for a wall thickness range from 120 to 300 mm. Door frame beams made of plywood. Door set price shown on see p. 133 includes door frame of "C" adjustment range.
- Corner profile steel door frame of 120mm wide profile. Made of steel sheet 1,5 mm thick. Standard option includes reinforcement for a door closer
- MDF fixed door frame equipped with hinge receivers with continuous 3D adjustment. It is possible to produce adjustable option of MDF frame for wall thickness from 160 mm - CONTRACT (bespoke) order.
- PROJECT BIS, PROJECT PREMIUM door frames (see p. 196).

NOTES

- Technical Assessment ITB-KOT-2017/0096 issue 1.
- National certification of constancy of performance No 020-UWB-2546/W (does not apply to 42 dB set with Porta System door frame)
- Acoustic rating Rw=42 dB (range 42-46 dB)
- In order to meet the requirements of building law, regarding fire-rating and sound-proofness, it is necessary to use a door closer.
- Door rails and stiles made of exotic wood, colourless varnished or stained
- Fire rated doors should be equipped with an escutcheon with a steel spindle
- In case of using different hardware to offered by PORTA, guarantee cards guidelines must be followed.

EXTRA CHARGES

- size '100'
- door leaf: CPL 0,2 mm and 0,7 mm veneers- GROUP II
- door frame: CPL 0,2 mm veneer - GROUP II
- decorative inlays for synthetic veneers (for 1 side, for both sides - the price x 2)
- decorative inlays for natural veneers (for 1 side, for both sides - the price x 2)
- door leaf: Natural Satin Oak White veneer
- door leaf: Natural Satin Oak veneer (other colours)
- door leaf: Natural Walnut veneer
- door frame: Natural Satin Oak White veneer
- door frame: Natural Satin Oak veneer (other colours)
- door frame: Natural Walnut veneer
- steel door frame: colours - GROUP II
- steel door frame profile for PROJECT BIS cover
- steel door frame profile for PROJECT PREMIUM cover
- steel door frame profile from 101 to 150 mm
- steel door frame profile from 151 to 270 mm
- steel door frame profile from 271 to 390 mm
- reinforcement for a door closer for Porta System frame
- handle with an escutcheon

(see p. 203)

Fire-rated EI 30, EI 60



Fire-rated EI 30

EI 30
Fire-resistance
Acoustic rating $R_w=34$ dB*

EI 60
Fire-resistance 60 min.
Acoustic rating $R_w=34$ dB*

All available models -see page 142



Model 3, Brown Oak, MDF door frame

ACOUSTIC RATING OF EI 30 AND EI 60 DOORS:

- $R_w=32$ dB (32–36 dB)



flush (EI 30)



model 2 (EI 60)



model 3
(EI 30, EI 30 soft)



examples of glazings
bespoke orders (EI30)



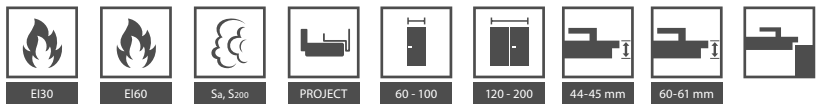

AVAILABLE FINISHES

Natural Select ★★★★★
 Natural Oak, Ash, Walnut
 Natural Oak Satin

CPL HQ 0,2 mm ★★★★★

CPL HQ 0,7 mm ★★★★★
 Gladstone/Halifax

Finishes charts see page 217 – 224.

NOTE! Natural veneers (except Ash and Walnut) are available in vertical or horizontal grain direction (applies only to door leaf)

NOTE! It is recommended to choose CPL or Gladstone/Halifax laminate for entrance door, especially if they are used in public buildings.

EI 30, EI 60

TECHNICAL INFORMATION

ACCESSORIES

- Hinges: Two or three (EI 30); four (EI 30 soft, EI 60)
- Cylinder lock
- Transparent, fire-resistant glass panel, (fixed width, not dependent on door leaf size)
- Intumescent strip (under high temperatures) - EI 30, Rw=42 Db option
- Automatic threshold seal
- A door leaf finished with CPL HQ or Gladstone/Halifax has lippping ABS on the side edges.

DOOR FRAMES

- MDF EI30 100 mm fixed door frame and adjustable one (min. 160 mm) (EI 30, EI 30 SOFT), equipped with adjustable hinges – heavy duty for EI 30 and adjustable barrel hinges for EI 30 SOFT
- Wooden door frame 120 mm (EI 60), made of three-ply glued softwood, equipped with adjustable barrel hinges
- Corner profile steel door frame, 100mm wide profile. Made from hot dip galvanized steel sheet 1,5 mm thick.
- Equipped with three-part hinges, dowels pins and reinforced for door closer.
- PROJECT BIS door frame (str.196).
- PROJECT PREMIUM door frame available with Individual Approval Documentation covered by Contracts department.

NOTES

- EI 30 Technical Assessment ITB-KOT-2017/0007 issue 1. and National certification of constancy of performance No 020-UWB-0567/W
- EI 60 Technical Assessment ITB-KOT-2018/0407 issue 1. and National certification of constancy of performance No 020-UWB-2707/W
- In order to meet the requirements of building law, regarding fire-rating and sound-proofness, it is necessary to use a door closer.
- Fire rated doors should be equipped with an escutcheon with a steel spindle
- In case of using different hardware to offered by PORTA, guarantee cards guidelines must be followed

- Red seals dor EI 60 doors
- Acoustic rating Rw=32 dB (32÷36 dB)
- Size '60' is not available for 'milled' OFFICE collection. Minimum width od door leaves with mouldings: moulding 1 – 444 mm, moulding 2 – 644 mm, moulding 3 – 468 mm, moulding 4 – 744 mm.
- EI 60 in size '100' is not available in standard offer (Porta CONTRACT, see page 226).
- double EI 30 SOFT is not available.

EXTRA CHARGES

- size '100' – EI 30
- door leaf: CPL 0,2 mm and 0,7 mm veneers– GROUP II
- door frame: CPL 0,2 mm veneer– GROUP II
- door leaf: Gladstone/Halifax finish, vertical grain
- third hinge (MDF door frame)
- decorative inlays for synthetic veneers (for 1 side, for both sides – the price x 2)
- decorative inlays for natural veneers (for 1 side, for both sides – the price x 2)
- door leaf: Natural veneer, White Oak, Satin
- door leaf: Natural veneer, Oak, Satin (other colours)
- door leaf: Natural veneer: Walnut
- adjustable door frame: Natural veneer, White Oak, Satin
- door frame: Natural veneer, Oak, Satin (other colours)
- door frame: Natural veneer, Walnut
- steel door frame: colours - GROUP II
- steel door frame profile for PROJECT BIS cover
- steel door frame profile from 101 to 150 mm
- steel door frame profile from 151 to 270 mm
- steel door frame profile from 271 to 390 mm
- quater rounds, architraves
- handle with an escutcheon

(see p. 206)
 (see p. 203)

ENDURO

TOP
INVESTMENT
COLLECTIONS



Interior technical doors with the highest durability, abrasion resistance class and resistance to various external conditions. Specially profiled edge guards made of stainless steel and. Finish - extremely durable HPL or CPL veneer.

An example of a bespoke order. Porta CONTRACT, see page 226.

10
YEAR
WARRANTY
CONSTRUCTION



ENDURO 3, Anthracite



solid



model 1



model 2



model 3



model 4

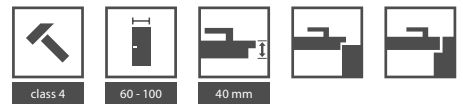

AVAILABLE FINISHES

HPL, CPL 0,7 veneer ★★★★★★

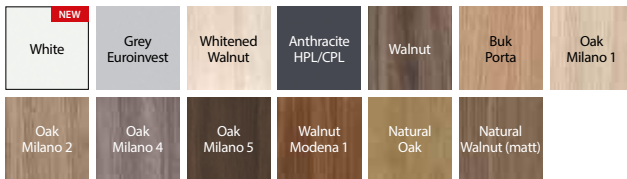

ENDURO - INDICATIONS FOR USE

- Laboratories
- Dental clinics
- Hospitals



push panel



kick panel



ventilation kick panel



ventilation grille

TECHNICAL INFORMATION

ACCESSORIES

- Reinforced three-part hinges (3 PCs)
- Swinging option: two (size '60'), three ('70'; '80'), or four ('90') hinges
- Transparent or frosted, tempered glass panel, (model 4 - laminated glass panel)
- Lock: key lock, WC lock, or cylinder lock
- Reinforcement for a door closer included

DOOR FRAMES

- Corner profile steel door frame, profile: 105 mm wide. Made from galvanized steel sheet 1,2 mm thick. Equipped with 3PCs of reinforced three-part hinges (which come with door leaf), rubber seal set circumferentially, six dowel pins. Powder coated (finishes charts see p. 224).
- Option of ordering two types of a door frame:
 - to install on finished floor level - '0'
 - to install below a floor level - '-30'

NOTES

- Technical Assessment AT-15-6515/2016 Warsaw, for swinging doors ITB-KOT-2017/0184 issue 1
- New installation method of edge guards - without interference with veneer structure
- Maximum size of a swinging door leaf - '90'

EXTRA CHARGES

- size '100'
- adjustable strike plate
- steel door frame: colours - GROUP II
- door frame profile from 80 to 100 mm
- door frame profile extension from 106 to 150 mm
- door frame profile extension from 155 to 270 mm
- door frame profile extension from 275 to 390 mm
- push panel - both sides set
- kick panel both sides set
- ventilation kick panel - both sides set
- ventilation grille
- swinging option
- handle with an escutcheon

(see p. 203)

AQUA



Thanks to the construction Aqua doors can be installed in business premises e.g. wellness centres, eating places.

AQUA 4, Grey



AQUA 4, Grey



solid



model 1



model 2



model 3



model 4

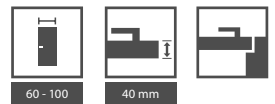

AVAILABLE FINISHES

Okleina HPL ★★★★★★



AQUA - INDICATIONS FOR USE:

- Eating places
- Shops
- Business premises
- Wellness centres
- Beauty parlours

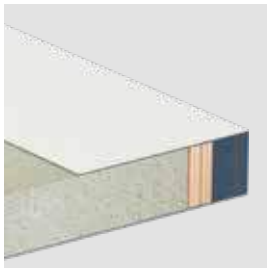

door leaf cross-section

TECHNICAL INFORMATION

ACCESSORIES

- Two stainless steel hinges
- Transparent or frosted, tempered glass panel, (model 4 - laminated glass panel)
- Lock: key lock, WC lock, or cylinder lock
- A door frame

DOOR FRAMES

- Corner profile steel door frame - LARGE, profile: 105 mm wide. Made from galvanized steel sheet 1,2 mm thick. Equipped with two hinges (which come with door leaf), rubber seal, set circumferentially, six dowel pins. Powder coated (finishes charts see p. 224).
- Option of ordering two types of a door frame:
 - to install on finished floor level - '0'
 - to install below a floor level - '-30'

NOTES

- Technical Assessment ITB-KOT-2017/0006 issue 1
- Door closer can be used

EXTRA CHARGES

- size '100'
- stainless steel ventilation grille
- steel door frame: colours - GROUP II
- door frame profile from 80 to 100 mm
- door frame profile extension from 106 to 150 mm
- door frame profile extension from 155 to 270 mm
- door frame profile extension from 275 to 390 mm
-  reinforcement for a door closer - door frame
- handle with an escutcheon

(see p. 226)
(see p. 203)

APARTMENT ENTRANCE DOORS

The collection of apartment entrance doors offers robust doors securing our apartments and other rooms which require high security. Porta EXTREME collection is particularly noteworthy - anti-burglary doors with acoustic rating, fire-resistance and smoke control.





Summary of models

apartment entrance doors and technical doors

PRESENTED COLLECTIONS OF MODELS APPLY AS:

- apartment entrance doors (see p. 144), OPAL (see p. 144), EXTREME RC 2 (see p. 146), QUARTZ (see p. 150), GRANITE RC3 (see p. 152), EXTREME RC 3 (see p. 154), GRANITE kl. C (see p. 156)
- technical doors Acoustic 27 dB (see p. 128), 32 dB (see p. 128), Porta SILENCE 37 dB, EI 30 (see p. 130), 42 dB (see p. 132), Fire-rated EI 30, EI 60 (see p. 134)

WITH DECORATIVE INLAYS: synthetic veneers - vertical graining,
Gladstone/Halifax finish models 3, 6, 9 - graining direction - according to decorative inlays orientation



decorative inlay 1



decorative inlay 3



decorative inlay 4



decorative inlay 6



decorative inlay 7



decorative inlay 8



decorative inlay 9

SOLID, synthetic veneer, glass applique



SOLID with a white glass applique*



SOLID with a black glass applique*

SOLID, natural veneer



SOLID- vertical graining



SOLID- horizontal graining

* available only for AGAT and OPAL collections (synthetic veneers)



WITH MOULDINGS, natural veneers*



moulding 1



moulding 2



moulding 3 with a raised panel



moulding 4 with a raised panel

* available only for Granite class C, AGAT, 27dB. Decorative mouldings are available only for a natural veneer OAK - price and production terms to be agreed with Porta's 'contract' department.

AGATE

apartment entrance doors 32 dB

OPAL

anti-burglary doors RC 2, 32 dB



AGATE Solid, Silver Acacia with a steel door frame

Burglar resistance RC2 (Opal)
Acoustic rating $R_w=32$ dB

All available models -see page 142



Solid OPAL with a glass applique, Silver Acacia with a steel door frame

OPAL DOOR

Doors with burglar resistance class RC2 according to PN EN 1627:2012 OPAL are also acoustic rated $R_w=32$ dB (32-36 dB). Opal remain burglar-resistant only as a part of a complete set: steel door frame (suggested by Porta), stainless steel threshold, a handle with an escutcheon (at least 2 class) and a cylinder (at least 4th class of burglary resistance).

AGATE DOOR

Reinforced Agate door is equipped with locks with security pins. It is acoustic rated $R_w=32$ dB (32-36 dB).



a lock with security pins - AGATE



dog bolts - AGATE, OPAL



4 point lock - OPAL



adjustable strike - steel door frame (optionally)



AVAILABLE FINISHES

Portasynchro 3D	★★★
Natural Select Natural Oak, Ash, Walnut Natural Oak Satin	★★★★
Portaperfect 3D CPL HQ 0,2 mm	★★★★★
CPL HQ 0,7 mm Gladstone/Halifax	★★★★★

Finishes charts see page 217 – 224.

NOTE! Natural veneers (except Ash and Walnut) are available in vertical or horizontal grain direction (applies only to door leaf)

NOTE! It is recommended to choose CPL or Gladstone/Halifax laminate for entrance door, especially if they are used in public buildings.



How to install OPAL doors- see video
www.porta.com.pl/dm/montazopal.wm

Doorset price:
door leaf+door frame+steel threshold+door viewer
(at an extra charge).

WE RECOMMEND!

THANKS TO THE ALUMINIUM LAYER, DOORS ARE EXCEPTIONALLY RESISTANT TO ADVERSE CONDITIONS OF USE, TEMPERATURE DIFFERENCES, AND HUMIDITY DIFFERENCES, WHICH ARE COMMON IN COMMUNAL AREAS.



TECHNICAL INFORMATION

DOOR LEAF CONSTRUCTION

Door leaf frame is made of glued laminated softwood. It is reinforced with stiles. Door leaf is skinned with a layer of aluminium sheet and wood-based board. Door leaves with silver decorative inlays are available. Natural veneers are finished with semi-matt varnish. A door leaf finished with CPL HQ or Gladstone/Halifax has lipping ABS on the side edges.

ACCESSORIES INCLUDED IN THE AGATE DOOR PRICE

- One or two locks with security pins
- Three barrel hinges
- Three dog bolts - NEW
- Door frame equipped with a standard stainless steel threshold (90 mm)

ACCESSORIES INCLUDED IN OPAL DOOR PRICE

- 4 point lock - for two cylinders
- Three barrel hinges (steel door frame), 3PCs of three-part hinges (MDF door frame)
- Anti-burglary plate (MDF door frame)
- Three dog bolts
- Steel door frame equipped with stainless steel threshold (90 mm)
- MDF door frame equipped with stainless steel threshold (90 mm) - threshold packed separately

DOOR FRAMES

- Corner profile steel door frame, profile 105 mm wide. Made from both sides galvanized steel sheet 1,2 mm thick (AGATE) or 1,5 mm thick (OPAL).
- Equipped with three barrel hinges, rubber seal set circumferentially. OPAL is additionally equipped with six dowel pins.
- PROJECT BIS, PROJECT PREMIUM door frames (see p. 196).
- Dedicated MDF door frame (OPAL)

NOTES

- Technical Assessment ITB-KOT-2017/0096 issue 1.
- Preparation for shortening (maximum 60 mm)
- Acoustic rating $R_w=32$ dB (32÷36 dB)

- A solid model of AGATE and OPAL with a glass applique is not available without a door viewer
- When ordering MDF door frame, architraves has to be ordered as well
- Threshold needs to be ordered separately in case of choosing OPAL with MDF door frame
- Threshold is a part of steel AGATE/OPAL door frame

EXTRA CHARGES

- door viewer
- size '100'
- adjustable lock strike plate (steel door frame)
- door frame: CPL 0,2 mm veneer- GROUP II
- door leaf: CPL 0,2 mm and 0,7 mm veneers- GROUP II
- door leaf: Gladstone/Halifax finish, vertical graining
- white or black glass applique (for solid models)
- decorative inlays for synthetic veneers (for 1 side, for both sides – the price x 2)
- decorative inlays for natural veneers (for 1 side, for both sides – the price x 2)
- door leaf: Natural veneer, White Oak, Satin
- door leaf: Natural veneer, Oak, Satin (other colours)
- door leaf: Natural veneer: Walnut
- adjustable door frame: Natural veneer, White Oak, Satin
- door frame: Natural veneer, Oak, Satin (other colours)
- door frame: Natural veneer, Walnut
- 6 dowel pins - AGATE door frame
- steel door frame: colours - GROUP II
- steel door frame: black
- steel door frame profile for PROJECT BIS cover
- steel door frame profile for PROJECT PREMIUM cover
- steel door frame profile from 106 to 150 mm
- steel door frame profile from 151 to 270 mm
- steel door frame profile from 271 to 390 mm
- reinforcement for a door closer for a steel door frame
- cylinder inserts
- a handle with an escutcheon

(see p. 204)

EXTREME RC 2

anti-burglary doors, class RC 2, 37 dB



Burglar resistance RC2
Acoustic rating $R_w = 40 \text{ dB}^*$

EXTREME RC2, Solid, Oak Milano 1 with a steel door frame

All available models -see page 142

EXTREME RC 2 doors

Extreme RC2 doors are equipped with 2 locks with 3 security pins, cylinders of class B and dog bolts.

The are:

- burglar resistant - class RC2 according to PN EN 1627:2012
- acoustic rated $R_w=37 \text{ dB}$ (37-41 dB)



EXTREME RC2, Oak Milano 1 with a steel door frame



lower lock - 3 security pins



upper lock - 3 security pins



dog bolts

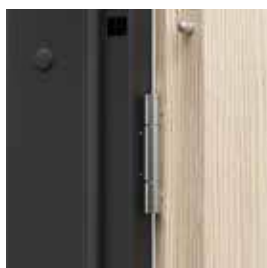

3 PCs of three-part hinges



adjustable lock strike (optional) - steel door frame



stainless steel threshold (90 mm)



AVAILABLE FINISHES

Natural Select ★★★★★
 Natural Oak, Ash, Walnut
 Natural Oak Satin

CPL HQ 0,2 mm ★★★★★

CPL HQ 0,7 mm ★★★★★
 Gladstone/Halifax

Finishes charts see page 217 – 224.

NOTE! Natural veneers (except Ash and Walnut) are available in vertical or horizontal grain direction (applies only to door leaf).

NOTE! It is recommended to choose CPL or Gladstone/Halifax laminate for entrance door, especially if they are used in public buildings.

WE RECOMMEND!

THANKS TO THE ALUMINIUM LAYER, RC 2 DOORS ARE EXCEPTIONALLY RESISTANT TO ADVERSE CONDITIONS OF USE, TEMPERATURE AND HUMIDITY DIFFERENCES, WHICH ARE COMMON IN COMMUNAL AREAS.



TECHNICAL INFORMATION

DOOR LEAF CONSTRUCTION

Core: special, 5-layer construction with rails and stiles made of glued laminated softwood, skinned with HDF. Available in rebated option.
 A door leaf finished with CPL HQ or Gladstone/Halifax has lipping ABS on the side edges.

ACCESSORIES INCLUDED IN THE DOOR PRICE

- Two locks with security pins (handle spacing 72 mm)
- Silver three-part hinges (3 PCs)
- Four dog bolts
- A door frame
- Standard stainless steel threshold (90 mm)

DOOR FRAMES

- Corner profile steel door frame, profile 100mm wide. Made from both sides galvanized steel sheet 1,5 mm thick.
- Equipped with three three-part hinges, rubber seal set circumferentially and eight dowel pins.
- PROJECT BIS door frame see p. 196.

NOTES

- Norm PN-EN 14351-2-2018-12
- Acoustic rating $R_w=37$ dB (37÷41 dB)

EXTRA CHARGES

- door viewer
- size '100'
- adjustable lock strike (steel door frame)
- door leaf: CPL 0,2 mm and 0,7 mm veneers– GROUP II
- door leaf: Gladstone/Halifax finish, vertical graining
- decorative inlays for synthetic veneers (for 1 side, for both sides – the price x 2)
- decorative inlays for natural veneers (for 1 side, for both sides – the price x 2)
- door leaf: Natural veneer, White Oak, Satin
- door leaf: Natural veneer, Oak, Satin (other colours)
- door leaf: Natural veneer: Walnut
- steel door frame: colours - GROUP II
- steel door frame: black colour
- steel door frame profile for PROJECT BIS cover
- steel door frame profile from 106 to 150 mm
- steel door frame profile from 151 to 270 mm
- steel door frame profile from 271 to 390 mm
- reinforcement for door closer for a steel door frame
- a handle with an escutcheon

(see p. 204)

Steel SAFE

anti-burglary doors, class RC 2 i RC 3



Burglar resistance
RC 2 and RC 3

Steel SAFE A.0 with a door viewer, Anthracite

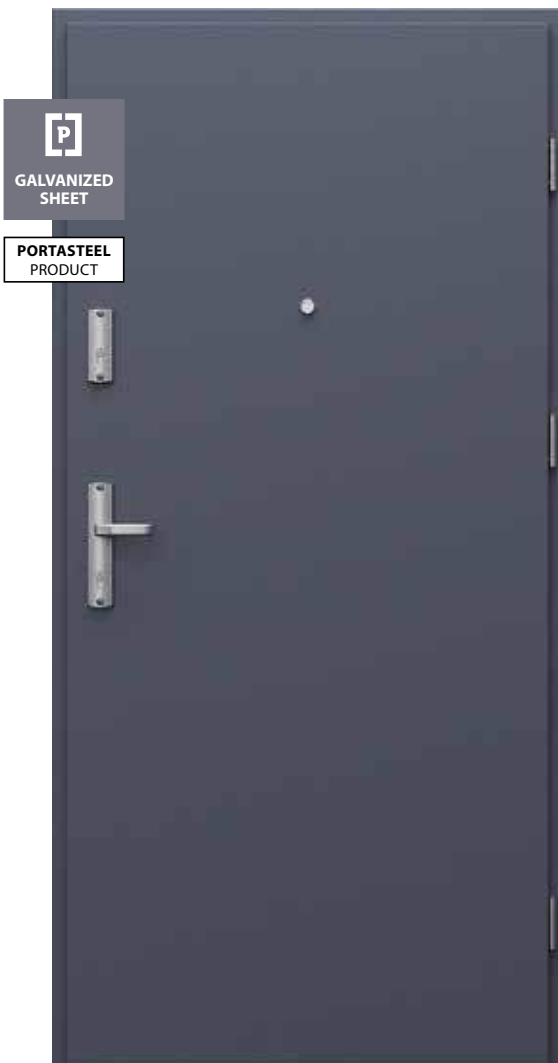

Steel SAFE, A.0 with a door viewer, Anthracite

Steel SAFE doors

Doors are equipped with two LOB locks and class B cylinder. Burglary resistance class RC 2 according to PN EN 1627:2012.

Doors are equipped with a WINKHAUS STV multipoint lock and two cylinders (class B). Burglary resistance class RC 3 according to PN EN 1627:2012.

PROTECTION SYSTEM OF STEEL SURFACES

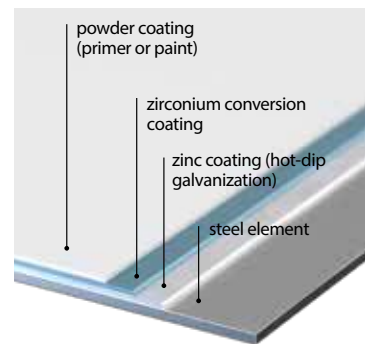

Steel SAFE door, type II
Lower lock - 3 security pins



Steel SAFE doors, type II
Upper lock - 3 security pins



Steel SAFE door, type III
Multipoint lock with hooks



Steel SAFE door, TYPE III
HOOK - upper/lower bolting

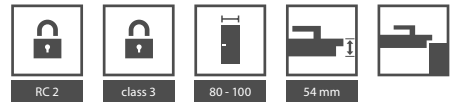

AVAILABLE FINISHES

Polyester Premium Paint ★★★★★☆



Laminated steel sheet (PVC) ★★★★★☆

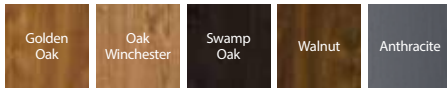

stainless steel threshold with a perforation



adjustable lock strike



Corner profile steel door frame - LARGE

TECHNICAL INFORMATION

DOOR LEAF CONSTRUCTION

The construction is based on double layer wooden rails and stiles. Expanded polystyrene with a large admixture of graphite is used as a thermal insulating infill. The construction is skinned with galvanized steel sheet 0,6 mm - film laminated (PVC) or coated with a polyester paint.

ACCESSORIES INCLUDED IN THE DOOR PRICE - TYPE II

- Three-part hinges (3 PCs)
- Two separate locks LOB
- Four dog bolts
- Opal handle
- Cylinders LOB class A
- Adjustable strike of a main lock
- Corner profile door frame
- Stainless steel threshold with a perforation

ACCESSORIES INCLUDED DOOR PRICE - TYPE III

- Three-part hinges (3 PCs)
- WINKHAUS STV multipoint lock
- Four dog bolts
- 'SAFE' handle
- Cylinders WILKA, class A
- Adjustable strike of a main lock
- Corner profile door frame
- Stainless steel threshold with a perforation

DOOR FRAMES

- Corner profile steel door frame, profile 100mm wide. Made from both sides galvanized steel sheet 1,2 mm thick (Type II) or 1,5 mm thick (Type III).

NOTES

- Technical Assessment ITB-KOT-2017/0008, issue 1

EXTRA CHARGES - TYPE II

- size '100'
- a door viewer
- two cylinders LOB, class B - exchange for standard set class A
- mineral wool infill
- reinforcement for a door closer
- a handle with an escutcheon (see p. 202)

EXTRA CHARGES - TYPE III

- size '100'
- an additional upper lock
- doorguard for paint coated doors
- door bar for film laminated doors (PVC)
- upper escutcheon class C
- door viewer
- cylinder WILKA, class B - exchange for standard set class A
- upper cylinder WILKA, class A
- upper cylinder WILKA, class B
- mineral wool infill
- reinforcement for a door closer
- a handle with an escutcheon (see p. 204)

QUARTZ RC 2

anti-burglary doors, class RC 2, EI 30, 32 dB



Burglary resistance class RC 2
Acoustic rating $R_w=34$ dB*
Fire-resistance EI 30
Smoke control

QUARTZ, decorative inlays 6, with a steel door frame

All available models -see page 142



QUARTZ, decorative inlays 6, with a steel door frame

QUARTZ doors

DT-K32 (QUARTZ type III) doors are equipped with a multipoint lock and dog bolts.

- They have following qualities:
- burglar resistance - class RC 2 according to PN EN 1627:2012
- acoustic rating $R_w=32$ dB (32-36 dB)
- fire resistance EI 30
- smoke control



Four point lock with two cylinders- QUARTZ III



dog bolts - QUARTZ III



reinforced three-part hinge

Detailed tests results are available on our website tab DOWNLOAD on www.porta.com.pl

DETAILED OFFER IS ALSO AVAILABLE ON www.portadoors.com



AVAILABLE FINISHES

Portasynchro 3D



Natural Select
Natural Oak, Ash, Walnut
Natural Oak Satin



Portaperfect 3D
CPL HQ 0,2 mm



CPL HQ 0,7 mm
Gladstone/Halifax



NOTE! Natural veneers (except Ash and Walnut) are available in vertical or horizontal grain direction (applies only to door leaf)

NOTE! It is recommended to choose CPL or Gladstone/Halifax laminate for entrance door, especially if they are used in public buildings.

Finishes charts see page 217 – 224.

WE RECOMMEND!

THANKS TO THE ALUMINIUM LAYER, QUARTZ DOORS ARE EXCEPTIONALLY RESISTANT TO ADVERSE CONDITIONS OF USE, TEMPERATURE AND HUMIDITY DIFFERENCES, WHICH ARE COMMON IN COMMUNAL AREAS.



TECHNICAL INFORMATION

DOOR LEAF CONSTRUCTION

Core: Multilayer construction which provides fire-resistance of 30 min and acoustic insulation of $R_w=34dB^*$. Thanks to a layer of aluminium sheet door leaves are extremely resistant to adverse conditions of use that are characteristic for communal areas. A door leaf finished with CPL HQ or Gladstone/Halifax has lipping ABS on the side edges.

ACCESSORIES INCLUDED IN DOOR PRICE

- A mortise cylinder lock with a rectangular deadbolt and (QUARTZ Type I)
- Two cylinder mortise locks with rectangular deadbolts (QUARTZ Type II)
- A 4-point lock with two cylinders and three dog bolts (QUARTZ Type III)
- Reinforced, silver three-part hinges (3 PCs)
- An intumescent seal in a door leaf rebate
- A door frame with a standard stainless steel threshold (90 mm)

DOOR FRAMES

- Corner profile steel door frame, profile 105mm wide. Made from both sides galvanized steel sheet 1,5 mm thick. Equipped with self-extinguishing gasket, three 3-part hinges, stainless steel threshold - standard 90 mm, reinforcement for a door closer. QUARTZ I has one lock strike, QUARTZ II - two lock strikes, QUARTZ III multipoint lock strike, six dowel pins and receivers for dog bolts.
- PROJECT BIS door frame (see p. 196).
- PROJECT Premium, available with Individual Approval Documentation covered by 'Contract' department

NOTES

- Technical Assessment ITB-KOT-2017/0007 issue 1.
- National certification of constancy of performance No 020-UWB-0567/W
- Preparation for shortening (maximum 60 mm)
- In order to meet the requirements of building law, regarding fire-rating and/or smoke control, it is necessary to use a door closer.
- In case of using different hardware to offered by PORTA, guarantee cards guidelines must be followed.
- Fire rated doors should be equipped with an escutcheon and a handle with a steel spindle
- Acoustic rating $R_w=32$ dB (32-36 dB)

EXTRA CHARGES

- door viewer
- size '100'
- door leaf: CPL 0,2 mm and 0,7 mm veneers – GROUP II
- door leaf: Gladstone/Halifax finish, vertical graining
- decorative inlays for synthetic veneers (for 1 side, for both sides – the price x 2)
- decorative inlays for natural veneers (for 1 side, for both sides – the price x 2)
- door leaf: Natural veneer, White Oak, Satin
- door leaf: Natural veneer, Oak, Satin (other colours)
- door leaf: Natural veneer, Walnut
- steel door frame: colours - GROUP II
- steel door frame: black colour
- steel door frame profile for PROJECT BIS cover
- steel door frame profile from 101 to 150 mm
- steel door frame profile from 151 to 270 mm
- steel door frame profile from 271 to 390 mm
- a handle with an escutcheon

(see p. 204)

GRANITE RC 3

anti-burglary doors, class RC 3, EI 30, 32 dB

TOP
INVESTMENT
COLLECTIONS



Burglary resistance class RC 3
Acoustic rating $R_w=32$ dB*
Fire-resistance EI 30
Smoke control

GRANITE RC 3, model: decorative inlays 8, Dark concrete

All available models -see page 142

GRANITE RC 3 doors

we offer two types:

Type I

- RC 3 burglary resistance class according to PN EN 1627-2012
- Acoustic rating $R_w=32$ dB (32-36 dB)
- smoke control

Type II

- Type I qualities
- fire-resistance EI 30



GRANITE RC 3, Dark Concrete, with a steel door frame



2 anti-burglary hooks
intumescent seal (Type II)



Winkhaus multipoint hook lock



4 dog bolts



professional heavy duty hinges

Detailed tests results are available on our website tab DOWNLOAD on www.porta.com.pl

DETAILED OFFER IS ALSO AVAILABLE ON www.portadoors.com



AVAILABLE FINISHES

Natural Select ★★★★★
 Natural Oak, Ash, Walnut
 Natural Oak Satin

CPL HQ 0,2 mm ★★★★★

CPL HQ 0,7 mm ★★★★★
 Gladstone/Halifax

Finishes charts see page 217 – 224.

NOTE! Natural veneers (except Ash and Walnut) are available in vertical or horizontal grain direction (applies only to door leaf)

NOTE! It is recommended to choose CPL or Gladstone/Halifax laminate for entrance door, especially if they are used in public buildings.

WE RECOMMEND!

THANKS TO THE ALUMINIUM LAYER, GRANITE RC 3 DOORS ARE EXCEPTIONALLY RESISTANT TO ADVERSE CONDITIONS OF USE, TEMPERATURE AND HUMIDITY DIFFERENCE WHICH ARE COMMON IN COMMUNAL AREAS.



TECHNICAL INFORMATION

DOOR LEAF CONSTRUCTION

Core: special 5-layer construction with rails and stiles made of glued laminated softwood, skinned with HDF. Available in rebated option.
 A door leaf finished with CPL HQ or Gladstone/Halifax has lipping ABS on the side edges.

ACCESSORIES INCLUDED IN DOOR PRICE

- Winkhaus STV hook lock with a pressure adjustment
- An anti-burglary cylinder
- A handle with an anti-burglary escutcheon, 'SAFE'
- 3 PCs of three-part hinges (steel door frame) or 2 PCs of heavy duty hinges (reinforced PS frame). Both options - silver.
- Four dog bolts
- Additionally: type II - high temperature intumescent seal on door leaf edges (apart from bottom edge)
- A door frame is equipped with a standard stainless steel threshold (90 mm) and a reinforcement for a door closer

DOOR FRAMES

- Corner profile steel door frame, profile 100mm wide. Made from both sides galvanized steel sheet 1,5 mm thick. Equipped with self-adhesive gasket, eight dowel pins and stainless steel threshold (120 mm).
- Reinforced Porta system door frame with an adjustment range 120-300 mm. Architraves 80 mm wide
- PROJECT BIS door frame (see p. 196).
- PROJECT Premium available with Individual Approval Documentation covered by Contracts department

NOTES

- Technical Assessment ITB-KOT-2017/0007 issue 1.
- National certification of constancy of performance No 020-UWB-0567/W
- In order to meet the requirements of building law, regarding fire-rating and/or smoke control, it is necessary to use a door closer.

- In case of using different hardware to offered by PORTA, guarantee cards guidelines must be followed.
- **Door guard is available only with a steel door frame** (inward opening).
- A fire-rated door- decorative inlays available only in both sides option.

EXTRA CHARGES

- a door viewer
- size '100'
- an additional upper lock
- a door guard
- an upper escutcheon
- a cylinder for the upper lock
- door leaf: CPL 0,2 mm and 0,7 mm veneers- GROUP II
- door leaf: Gladstone/Halifax finish, vertical graining
- decorative inlays for synthetic veneers (for 1 side, for both sides – the price x 2)
- decorative inlays for natural veneers (for 1 side, for both sides – the price x 2)
- door leaf: Natural veneer, White Oak, Satin
- door leaf: Natural veneer, Oak, Satin (other colours)
- door leaf: Natural veneer, Walnut
- steel door frame: colours - GROUP II
- steel door frame: black colour
- steel door frame profile for PROJECT BIS cover
- steel door frame profile from 101 to 150 mm
- steel door frame profile from 151 to 270 mm
- steel door frame profile from 271 to 390 mm
- a handle with an escutcheon, 'SAFE'

(see p. 204)

EXTREME RC 3

anti-burglary doors, class RC 3, EI 30, 37 dB

TOP
INVESTMENT
COLLECTIONS



Burglary resistance class RC 3
Acoustic rating $R_w=40$ dB*
Fire-resistance EI 30
Smoke control

EXTREME RC 3, Sand Oak with a reinforced PS door frame

All available models -see page 142

EXTREME doors

we offer two types:

Type I

- RC 3 burglary resistance class according to PN EN 1627-2012
- Acoustic rating $R_w=37$ dB (37-41 dB)
- smoke control

Type II

- Type I qualities
- fire-resistance EI 30



EXTREME RC3, Sand Oak with a reinforced PS door frame

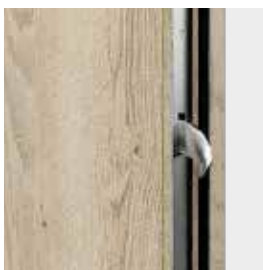

2 anti-burglary hooks



Winkhaus multipoint lock with hooks



4 dog bolts intumescent seal (Type II)



Porta SYSTEM door frame

Detailed tests results are available on our website tab DOWNLOAD on www.porta.com.pl

DETAILED OFFER IS ALSO AVAILABLE ON www.portadoors.com



AVAILABLE FINISHES

Natural Select ★★★★★
 Natural Oak, Ash, Walnut
 Natural Oak Satin

CPL HQ 0,2 mm ★★★★★

CPL HQ 0,7 mm ★★★★★
 Gladstone/Halifax

Finishes charts see page 217 – 224.

NOTE! Natural veneers (except Ash and Walnut) are available in vertical or horizontal grain direction (applies only to door leaf)

NOTE! It is recommended to choose CPL or Gladstone/Halifax laminate for entrance door, especially if they are used in public buildings.

WE RECOMMEND!

THANKS TO THE ALUMINIUM LAYER, EXTREME DOORS ARE EXCEPTIONALLY RESISTANT TO ADVERSE CONDITIONS OF USE, TEMPERATURE AND HUMIDITY DIFFERENCES, WHICH ARE COMMON IN COMMUNAL AREAS.



TECHNICAL INFORMATION

DOOR LEAF CONSTRUCTION

Core: special 5-layer construction with rails and stiles made of glued laminated softwood, skinned with HDF. Available in rebated option.
 A door leaf finished with CPL HQ or Gladstone/Halifax has lipping ABS on the side edges.

ACCESSORIES INCLUDED IN THE DOOR LEAF PRICE

- Winkhaus STV hook lock with a pressure adjustment and an additional upper lock
- Two anti-burglary cylinders
- A handle with an anti-burglary escutcheon,SAFE'
- An upper escutcheon,SAFE'
- 3 PCs of three-part hinges (steel door frame) or 2 PCs of heavy duty hinges (reinforced PS frame). Both options - silver.
- Four dog bolts
- Additionally: type II - high temperature intumescent seal on door leaf edges (apart from bottom edge)
- Door frame is equipped with a standard stainless steel threshold (90 mm) and reinforcement for a door closer

DOOR FRAMES

- Corner profile steel door frame, profile 100mm wide. Made from both sides galvanized steel sheet 1,5 mm thick. Equipped with self-adhesive gasket, eight dowel pins and a stainless steel threshold (120 mm).
- Reinforced Porta system door frame with an adjustment range 120-300 mm. Architraves 80 mm wide
- PROJECT BIS door frame (see p. 196).
- PROJECT Premium available with Individual Approval Documentation covered by Contracts department

NOTES

- Technical Assessment ITB-KOT-2017/0007 issue 1.
- National certification of constancy of performance No 020-UWB-0567/W
- In order to meet the requirements of building law, regarding fire-rating and/or smoke control, it is necessary to use a door closer.

- Fire rated doors should be equipped with an escutcheon and a handle with a steel spindle
- In case of using different hardware to offered by PORTA, guarantee cards guidelines must be followed.
- **A door guard is available only with a steel door frame** (inward opening).
- A fire-rated door - decorative inlays are available only for both sides option.

EXTRA CHARGES

- a door viewer
- size '100'
- a door guard
- door leaf: CPL 0,2 mm and 0,7 mm veneers - GROUP II
- door frame: CPL 0,2 mm veneer - GROUP II
- door leaf: Gladstone/Halifax finish, vertical graining
- decorative inlays for synthetic veneers (for 1 side, for both sides - the price x 2)
- decorative inlays for natural veneers (for 1 side, for both sides - the price x 2)
- door leaf: Natural veneer, White Oak, Satin
- door leaf: Natural veneer, Oak, Satin (other colours)
- door leaf: Natural veneer, Walnut
- door frame: Natural veneer, White Oak, Satin
- door frame: Natural veneer, Oak, Satin (other colours)
- door frame: Natural veneer: Walnut
- steel door frame: colours - GROUP II
- steel door frame: black colour
- steel door frame profile for PROJECT BIS cover
- steel door frame profile from 101 to 150 mm
- steel door frame profile from 151 to 270 mm
- steel door frame profile from 271 to 390 mm
- a handle with an escutcheon,SAFE'

(see p. 204)

GRANITE class C

anti-burglary doors, class C, EI 30, 32 dB



Burglary resistance class RC 3
and class C
Acoustic rating $R_w=36$ dB*
Fire-resistance EI 30

GRANITE class C, Natural Walnut with a door frame and a PROJECT BIS door frame cover

All available models -see page 142

GRANITE DOORS cl. C

we offer two types:

Type I

- „C” burglary resistance class
- RC3 burglary resistance class according to PN EN 1627-2012
- Acoustic rating $R_w=32$ dB (32-36 dB)
- smoke control

Type II

- Type I qualities
- fire-resistance EI 30



GRANITE Solid, Natural Walnut with a steel door frame

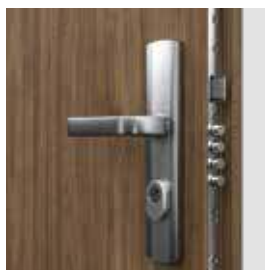

two cylinder multipoint lock with security pins

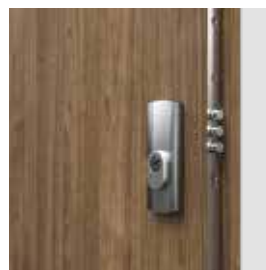

reinforced three-part hinge



dog bolts

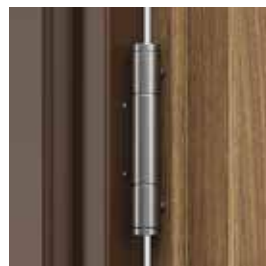

reinforced three-part hinge

Detailed tests results are available on our website tab DOWNLOAD on www.porta.com.pl

DETAILED OFFER IS ALSO AVAILABLE ON www.portadoors.com

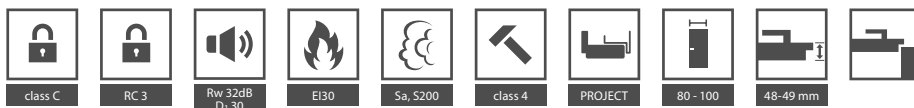

AVAILABLE FINISHES

Natural Select ★★★★★
 Natural Oak, Ash, Walnut
 Natural Oak Satin

CPL HQ 0,2 mm ★★★★★

CPL HQ 0,7 mm ★★★★★

Finishes charts see page 217 – 224.

NOTE! Natural veneers (except Ash and Walnut) are available in vertical or horizontal grain direction (applies only to door leaf)

NOTE! It is recommended to choose CPL or Gladstone/Halifax laminate for entrance door, especially if they are used in public buildings.

WE RECOMMEND!

THANKS TO THE ALUMINIUM LAYER, GRANITE DOORS ARE EXCEPTIONALLY RESISTANT TO ADVERSE CONDITIONS OF USE, TEMPERATURE AND HUMIDITY DIFFERENCES, WHICH ARE COMMON IN COMMUNAL AREAS.



How to install Granite doors, using dowel pins - see video www.porta.com.pl/dm/montazgranitnadyble.wm



How to install Granite doors, using an expanding foam - see video www.porta.com.pl/dm/montazgranitnapianke.wm

TECHNICAL INFORMATION

DOOR LEAF CONSTRUCTION

Rails and stiles made of glued softwood. The construction is skinned with special double layer aluminium sheet and HDF. Silver decorative inlays available. Natural veneers are finished with semi-matt varnish.

Granite doors are perfect for the most demanding customers, who appreciate safety based on the highest quality of both: workmanship and materials. A door leaf finished with CPL HQ or Gladstone/Halifax has liping ABS on the side edges.

ACCESSORIES INCLUDED IN DOOR PRICE

- Multipoint lock with security pins, class 4
- Two anti-burglary cylinders, class 'C'
- A handle with an anti-burglary escutcheon 'GRANITE' or 'GRANITE PLUS' (at an additional charge)
- An upper escutcheon
- Four dog bolts
- A preparation for shortening, maximum 60 mm (regards Granite type I)
- Additionally: type II - high temperature intumescent seal on door leaf edges
- Door frame equipped with a stainless steel threshold, (wider option- 120 mm) and reinforcement for a door closer

DOOR FRAMES

- Corner profile steel door frame, profile 100 mm wide. Made from galvanized steel sheet 1,5 mm thick. Equipped with self-adhesive gasket, eight dowel pins and a stainless steel threshold (120 mm).
- PROJECT BIS door frame (see p. 196).
- PROJECT Premium (see p. 196).

NOTES

- Technical Assessment ITB-KOT-2017/0242 issue 1.
- National certification of constancy of performance No 020-UWB-2618/W
- In order to meet the requirements of building law, regarding fire-rating and/or smoke control, it is necessary to use a door closer.
- Fire rated doors should be equipped with an escutcheon and a handle with a steel spindle
- In case of using different hardware to offered by PORTA, guarantee cards guidelines must be followed.
- Acoustic rating $R_w=32$ dB (32-36 dB).

EXTRA CHARGES

- a door viewer
- size '100'
- an adjustable lock strike (Type I)
- door leaf: CPL 0,2 mm and 0,7 mm veneers- GROUP II
- decorative inlays for synthetic veneers (for 1 side, for both sides – the price x 2)
- decorative inlays for natural veneers (for 1 side, for both sides – the price x 2)
- door leaf: Natural veneer, White Oak, Satin
- door leaf: Natural veneer, Oak, Satin (other colours)
- door leaf: Natural veneer, Walnut
- steel door frame: colours - GROUP II
- steel door frame: black colour
- steel door frame profile for PROJECT BIS cover
- steel door frame profile for PROJECT Premium
- steel door frame profile from 101 to 150 mm
- steel door frame profile from 151 to 270 mm
- steel door frame profile from 271 to 390 mm
- a handle with an escutcheon GRANITE PLUS

(see p. 204)

EXTERNAL ENTRANCE DOORS PASSIVE AND ENERGY EFFICIENT

Steel entrance doors from our 'Steel' collection are designed with innovative technology and include. Precisely chosen features to create a product with the highest quality.

Wooden doors Eco POLAR and ECO POLAR PASSIVE are the perfect choice for passive houses.





Steel SAFE, ENERGY PROTECT

Burglar resistant locks, class 3 or 4. Anti-burglary glazing class P4



TOP
INVESTMENT
COLLECTIONS

Burglary resistance RC2/RC3*
Thermal transmittance $U_d=1.1\div 1.7^*$

Steel SAFE E.1, Oak Winchester

$U_d=1,1^*$
W/m²K
THERMAL
TRANSMITTANCE

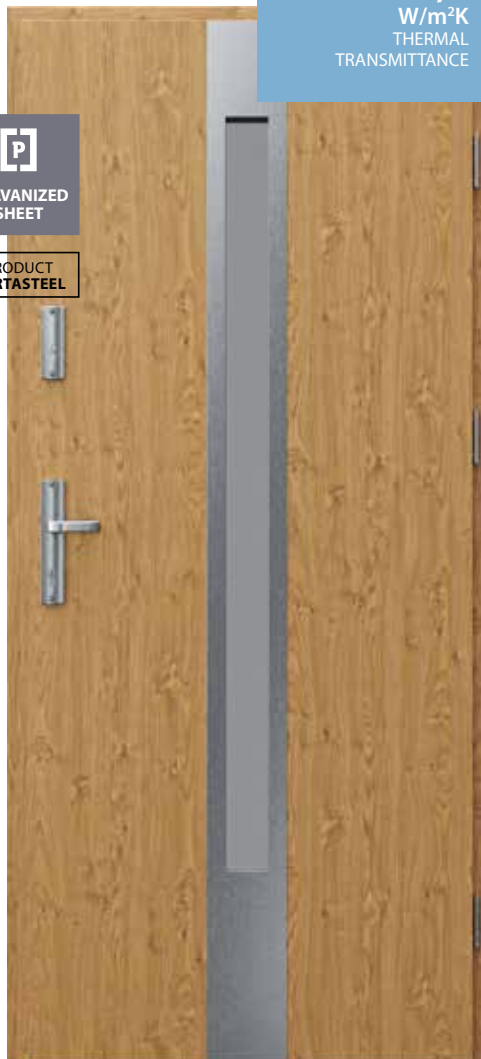

Steel ENERGY PROTECT C.1, Oak Winchester

P
GALVANIZED
SHEET

PRODUCT
PORTASTEEL

PROTECTION SYSTEM OF STEEL SURFACES

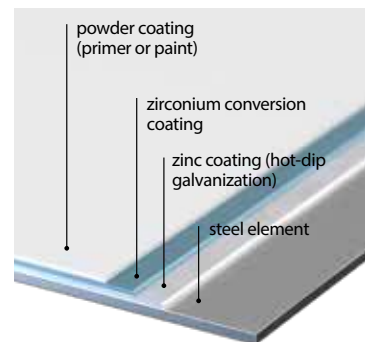

model A.0



model B.1



model C.1



model D.1



model E.1

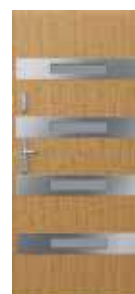

model F.1

* Dotyczy drzwi pełnych. Szczegółowe wyniki badań dostępne w zakładce DO POBRANIA na stronie www.porta.com.pl

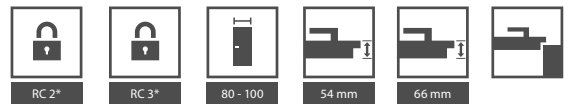

AVAILABLE FINISHES

Polyester Premium Paint ★★★★★☆

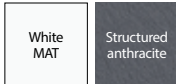

Laminated steel sheet (PVC) ★★★★★☆

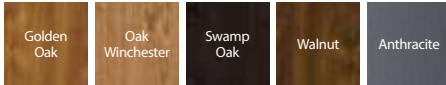

Steel door frame Thermo



Hook - upper/lower bolting. SAFE type III, ENERGY PROTECT



Multipoint lock SAFE type III, ENERGY PROTECT



4 dog bolts



3 PCs of three-part hinges



Infill - expanded polystyrene



Triple glazing - class P4



Thermal barrier threshold - it reduces heat transfer coefficient along with,Thermo' door frame

Steel SAFE
ENERGY PROTECT

TECHNICAL INFORMATION

BASIC INFORMATION

- 'SAFE' doors (door leaf thickness 54 mm)
- Burglar resistance class RC2 or RC 3 (regards solid door leaves)
- Two independent LOB locks or Winkhaus STV hook lock
- Corner profile frame 'LARGE' or,Thermo' door frame
- Stainless steel perforated threshold or a thermal barrier threshold
- 3 PCs of three-part hinges
- Four dog bolts
- OPAL or SAFE handle
- LOB or WILKA cylinders
- An adjustable lock strike

EXTRA CHARGES - SAFE DOORS TYPE II, III, ENERGY PROTECT

- size '100'
- A door viewer
- A bottom drip cap (door leaf colour)
- A stainless steel kick panel 150 mm, models: A0, B1, F1
- Mineral wool infill
- A protection set for the bottom edge in case of self-shortening
- Two cylinders LOB, class B - exchange for a standard set class A (SAFE TYPE II)
- A lower cylinder WILKA class B - exchange for a STD set, class A (SAFE TYPE III)
- An upper cylinder WILKA class A (SAFE TYPE III)
- A lower cylinder WILKA class B - exchange for std. set, class A (ENERGY PROTECT)
- Round or rectangular pull (see p. 205)

BASIC INFORMATION

- 'ENERGY PROTECT' door (door leaf thickness 66 mm)
- Burglar resistance class RC 3 (regards solid door leaves)
- Winkhaus STV hook lock
- 'Thermo' door frame
- Stainless steel thermal barrier threshold
- 3 PCs of three-part hinges
- Four dog bolts
- 'SAFE' handle
- WILKA cylinder
- An adjustable lock strike

EXTRA CHARGES - TYPE III ENERGY PROTECT

- An additional upper lock
- A door guard (paint coated doors)
- A door guard (film laminated doors PCV)
- An upper escutcheon, class C
- An upper cylinder WILKA, class B



Eco POLAR, Eco POLAR PASSIVE

Burglar resistant locks, class 4. Anti-burglary glazing class P4

TOP
INVESTMENT
COLLECTIONS



Doors are made out of laminated oak.
Be ECO, Save ENERGY!

The Innovative Technology helps to save Energy & Be Eco-Friendly. Precisely chosen features create a product with the highest quality. ECO POLAR PASSIVE Doors are perfect solution for passive houses.

Eco POLAR PASSIVE A.5, White

$U_d = 0,7^*$
W/m²K
THERMAL
TRANSMITTANCE



Eco POLAR PASSIVE C.3 both sides glass panel Oak 6 (white)



solid



model A.1



model A.2



model A.3

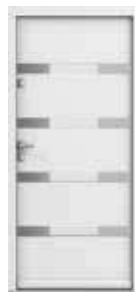

model A.4



model A.5



model C.3
both sides glass
panel



model C.4
both sides glass
panel

EXAMPLES OF TRANSOMS  Transoms can be ordered through Porta, 'COTRACT', see page 226.



DOUBLE
for a right door



SOLID RIGHT
for a right door



RIGHT
for a right door

Decide transom side looking at hinges side.

* Regards solid doors only. Detailed tests results are available on our website tab DOWNLOAD on www.porta.com.pl

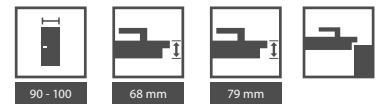

AVAILABLE FINISHES

Water-based exterior varnish ★★★★★☆

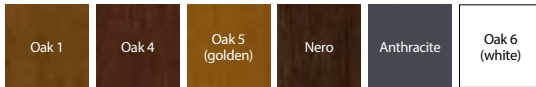

K Customize colours to meet your individual needs. Send an enquiry through Porta CONTRACT. Details regarding bespoke orders, see page 226.



Two anti-burglary locks with security pins, class 4



Thermal barrier threshold, Porta ThermControl**

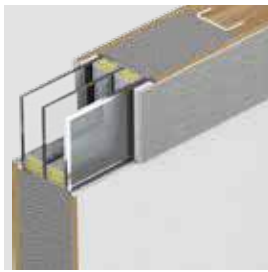

Anti-burglary glazing with double air space, class P4 and a stainless steel glazing bead



French rebate hinge side

IMPORTANT!

Stainless steel glazing bead is on one side only (external).

TECHNICAL INFORMATION

DOOR LEAF CONSTRUCTION

Surface finished with a natural veneer. In a door leaf frame we put steel profile which enhances rigidity of the construction. Glazing with double air space (U=0,5 Wm²K) brown reflex glass. Glazing bead made of stainless steel (on one side of the door).

Threshold made of glued laminated oakwood and stainless steel.

Eco POLAR PASSIVE

- Door leaf thickness 79 mm
- Three seals set circumferentially

Eco POLAR

- Door leaf thickness 68 mm
- Two seals set circumferentially

ACCESSORIES INCLUDED IN DOOR PRICE

- Two independent cylinder locks - 4th class of burglar resistance
- Three adjustable hinges (3D)
- A thermal barrier threshold - 'Porta ThermControl'
- A temporary cylinder
- A thermal insulating glazing set for glazed models
- A door frame made of glued laminated oakwood

DOOR FRAMES

- A door frame (93 mm thick) is made of multilayered glued laminated oakwood
- A French rebate on hinge side, which prevents attempts of forcing the door

** Registered marketing name

NOTES

- Detailed parameters of thermal transmittance, see p.224
- **Porta Synergy**** In case of installation a transom (transoms), transom frame with a fixed upper jamb and lower jamb with a threshold are a part of a door frame.
- An innovative method of connecting transoms eliminates thermal bridges and makes installation easier
- Models C4, C3 without a drip cap.

EXTRA CHARGES

- size '100'

CREATE YOUR OWN PERFECT SET THAT MEETS YOUR NEEDS - CHOOSE FROM ALL AVAILABLE ACCESSORIES
(more information on <https://www.portadoors.com/do-pobrania>)

PRICES

- Premium hinge - Simonswerk series 4000 (3 PCs)
- Winkhaus STV multipoint lock with a pressure adjustment
- Mini escutcheon*
- A straight pull on one side (round) 1500 mm
- A straight pull on one side (rectangular) 1500 mm
- A straight pull on one side (round) 900 mm
- A curved pull on one side (round) 900 mm
- Hinges caps (set for 1 PCs)
- CORTES silver handle with an escutcheon - for one side
- CORTES silver handle with an escutcheon - for both sides

* available for Eco Polar Passive collection only

STEEL
TECHNICAL
DOORS

PORTA STEEL
PRODUCTS

LONG LASTING
DURABILITY



QUALITY
GUARANTEED

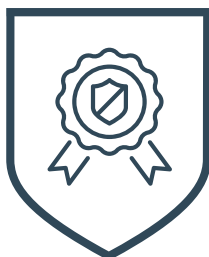

MODERN
DESIGN

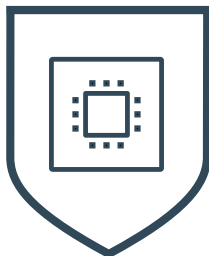

EASY
INSTALLATION

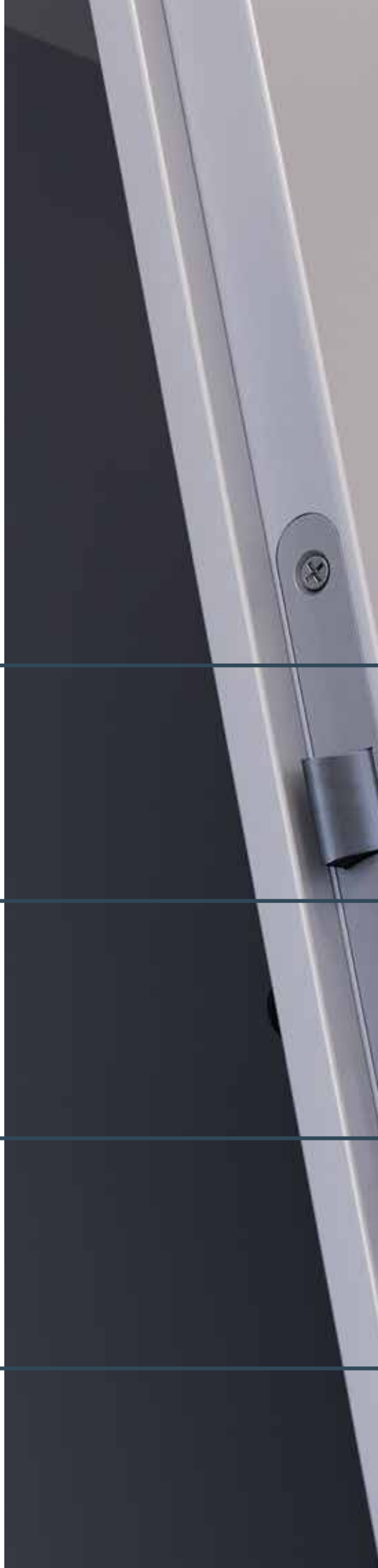

- 
- we use galvanized steel sheets for all of our steel products
 - high quality Premium coatings
 - various finishes: polyester paint, stainless steel, PVC laminated steel sheet, coated steel sheet
 - tested for the highest durability
 - to use for internal doors, technical doors, apartment entrance doors and external doors

- each product is precisely made
- long lasting corrosion protection
- 18 years experience in producing steel products
- high performance and technical parameters

- highly functional and aesthetically pleasing products
- a wide range of colours of the highest quality Premium Polyester Paints
- surface: matt, gloss, textured
- made to order, products available – according to architectural design
- suitable for public buildings, residential buildings, schools, shopping centres, underground car parks

- quick and easy installation
- produced to the required standards
- accessories improving door functionality
- suitable for installation to masonry, concrete and plasterboard

Multipurpose doors

for utility rooms and storage rooms



Multipurpose doors, model 2, Grey

Multipurpose, galvanized, robust doors are perfectly suitable for utility rooms, industrial rooms and also for basements, attics or storage rooms.

right or left?
reversible!



GALVANIZED SHEET

PORTA STEEL PRODUCT



Industrial pattern
W.121254

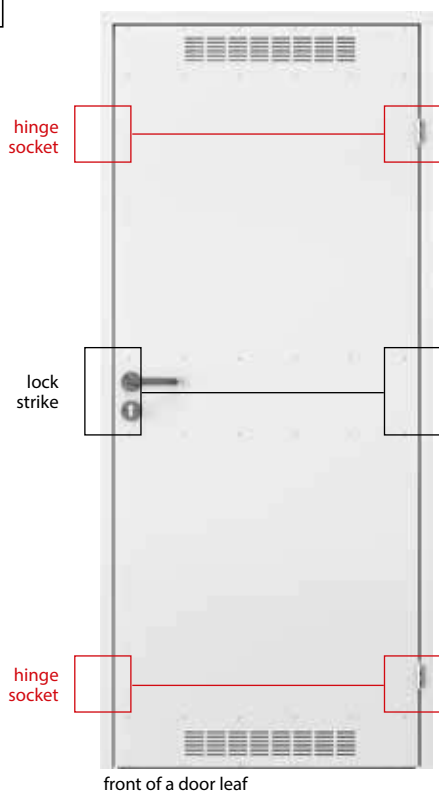

PROTECTION SYSTEM OF STEEL SURFACES

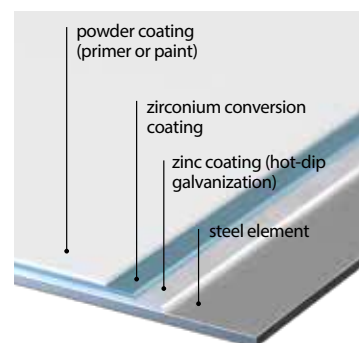



LONG LASTING DURABILITY



QUALITY GUARANTEED



MODERN DESIGN



EASY INSTALLATION



left / right



70 - 90



AVAILABLE FINISHES

Galvanized steel sheet ★★★★★☆



Premium polyester paint ★★★★★☆

Group I	NEW White MAT	NEW Grey MAT	Structured anthracite
	White	Grey	Brown
Group II			



handle



ventilation grille



4 ADVANTAGES IN 1
SEE MORE

www.porta.com.pl/dm/universalne_montaz.wmv

TECHNICAL INFORMATION

A DOOR SET INCLUDES

- A door leaf (paint coated galvanized steel sheet)
- A ventilation grille (optional)
- Two standard barrel hinges
- A cylinder lock
- Hinges caps (set for 1 PCs)
- An economical, plastic handle with a round escutcheon
- A corner profile frame

A DOOR FRAME

- A corner profile frame, profile 48 mm wide. Made of 0,8 mm thick steel sheet, both sides galvanized.

NOTES

- **Technical Assessment AT-15-8081/2016, ITB Warsaw.**
- Thanks to symmetrical construction and reversible hardware (handle, hinges) doors can be installed as right or left-handed.
- **Galvanized steel sheet, reinforced in three levels.**

EXTRA CHARGES

- colours - GROUP II

Steel BASIC, Steel BASIC PLUS



Steel BASIC, Grey

An economical solution with a sufficient level of performance features.

Galvanized steel construction guarantees durability and reliability.

„Steel BASIC“: The price of the internal door set includes:

- a door leaf
- a door frame
- a handle
- galvanized steel construction

„Steel BASIC PLUS“: The price of the external door set includes:

- a door leaf
- a door frame
- threshold
- a handle
- a galvanized steel construction



Steel BASIC PLUS, Coated steel sheet, Grey



GALVANIZED SHEET

PORTA STEEL PRODUCT



a handle and a lock



a ventilation grille



a powder paint coated threshold (Steel BASIC PLUS)



a drip cap (STEEL BASIC PLUS)



LONG LASTING DURABILITY



QUALITY GUARANTEED



MODERN DESIGN



EASY INSTALLATION



80 - 100



40 mm



AVAILABLE FINISHES

Galvanized steel sheet ★★★★★☆



Coated steel sheet ★★★★★☆

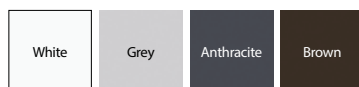

honeycomb core



expanded polystyrene infill

TECHNICAL INFORMATION

A DOOR SET INCLUDES

- A door leaf (steel sheet 0,5 mm, galvanized or galvanized and coated with a polyester paint)
- Two standard barrel hinges
- A cylinder lock
- A set of handles with escutcheons
- A corner profile frame (galvanized steel)
- A threshold (steel BASIC PLUS)
- A drip cap (steel BASIC PLUS)

A DOOR LEAF INCLUDES

- A door leaf
- Two standard barrel hinges
- A cylinder lock

DOOR FRAME

- A corner profile frame, profile 64 mm wide (like Corner profile - SMALL PLUS). Made of 1,2 mm thick steel sheet, galvanized or powder paint coated.
- Steel BASIC door frame has a seal. Steel BASIC PLUS has a seal set circumferentially.
- Door frame- right or left, ready to be mounted on a finished floor level.

NOTES

- **STEEL BASIC AT-15-8081/2016, ITB Warsaw, internal doors.**
- **Steel BASIC PLUS: PN:EN 14351-1+A1:2010 external doors.**
- Steel BASIC doors available only in 'investment norm' (see dimensions see p. 211, tab 3).
- Steel BASIC door leaf is produced in Polish norm and investment norm
- Steel BASIC PLUS doors, inward opening, are equipped with a drip cap.
- **Due to the specifics of used material (coated steel), colours of the products are similar to colours of RAL palette.**

EXTRA CHARGES

- drip cap (Steel BASIC PLUS)
- ventilation grille (Steel BASIC)

Steel SOLID



Steel SOLID, solid, Grey

INDICATIONS FOR USE:

- harsh conditions of use
- utility rooms
- industrial rooms
- backup facilities
- basements
- garages
- workshops
- industrial buildings
- modern residential interiors and offices (loft design)

P
GALVANIZED SHEET
PORTA STEEL PRODUCT



Steel SOLID 1, Grey

PROTECTION SYSTEM OF STEEL SURFACES

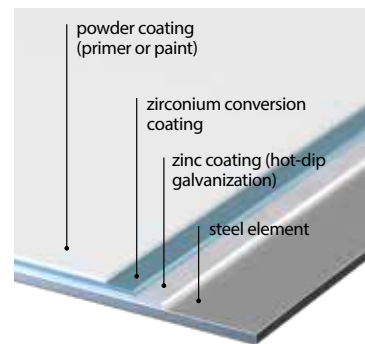

solid



model 1



model 2



model 3



model 4



model 5



LONG LASTING DURABILITY



QUALITY GUARANTEED



MODERN DESIGN



EASY INSTALLATION



120 - 200



60 - 100



40 mm



AVAILABLE FINISHES

Galvanized steel sheet ★★★★★☆



Stainless steel ★★★★★★



Premium polyester paint ★★★★★☆

Laminated steel sheet (PVC) ★★★★★☆

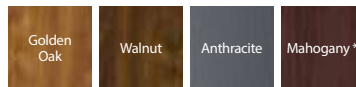

* until stocks last

Custom colours available through Porta CONTRACT, details regarding bespoke orders, see page 226.



Group I	NEW	White MAT	NEW	Grey MAT	Structured anthracite
	Group II	White	Grey	Brown	



honeycomb core



expanded polystyrene infill

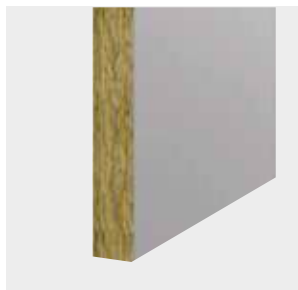

mineral wool infill

TECHNICAL INFORMATION

A DOOR LEAF INCLUDES

- A door leaf (galvanized steel sheet 0,6 mm, powder paint coated)
- Two standard barrel hinges (three hinges for size '100')
- A cylinder lock
- Frosted or transparent glass panel

SUGGESTED DOOR FRAMES

- A corner profile frame - SMALL PLUS, LARGE, FOLDING LARGE
- Steel ADJUSTABLE (standard), ADJUSTABLE 'PS' with 'sharp edges'
- Porta SYSTEM steel door frame

NOTES

- Technical Assessment AT-15-8081/2016, ITB Warsaw.
- Door leaves with expanded polystyrene infill are available only in polyester premium paint finish.
- Door leaves skinned with laminated steel sheet - glazing available only with flat stainless steel glazing bead.

- Double doors are available in any door leaf size combinations.
- Stainless steel door leaves are available only in Porta CONTRACT offer (as a bespoke order).

EXTRA CHARGES

- size '100' (galvanized steel doors)
- size '100' (stainless steel doors)
- colours - GROUP II
- Premium polyester paint and laminated steel (PCV): anthracite
-  stainless steel ventilation grille
- reinforcement for a door closer
- a handle with an escutcheon

(see p. 203)

Steel EI 30, EI 60



Steel EI 30, model 3, Anthracite

EI 30
Fire-resistance 30 min.

EI 60
Fire-resistance 60 min.
Smoke control
Acoustic rating $R_w=40$ dB*

PROTECTION SYSTEM OF STEEL SURFACES

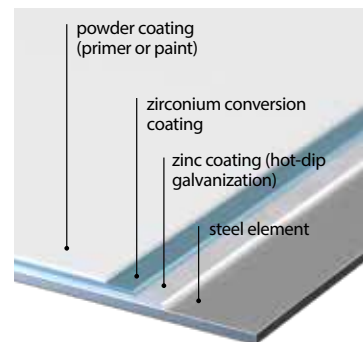

EI 60 doors

We offer two types:

Standard:

- fire-resistance 60 min
- Strength performance class 3

Typ 1:

- Standard type qualities
- smoke control Sa, Sm
- Acoustic rating $R_w=37$ dB (37-41 dB)

P
GALVANIZED SHEET
PORTA STEEL PRODUCT



Steel EI 30, model 1, Grey

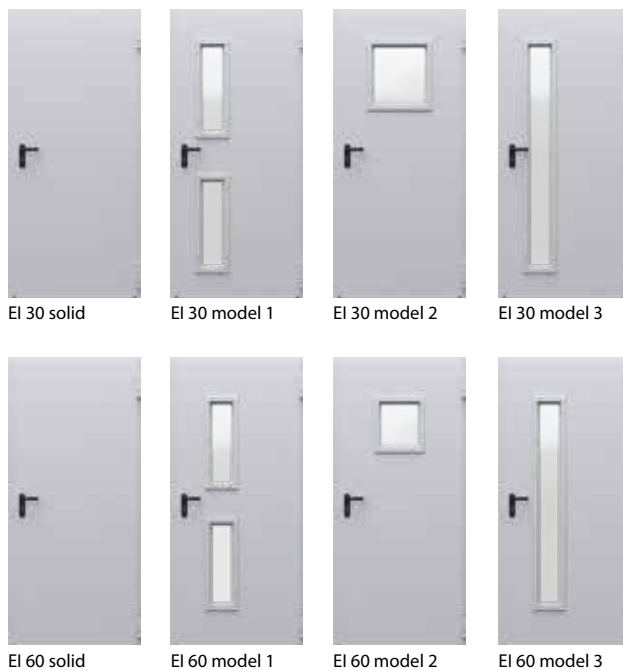

Detailed tests results are available on our website tab DOWNLOAD on www.porta.com.pl



EI60
EI30



Sa, Sm



Rw 37dB



class 4
class 2



80 - 100



67 mm
53 mm



AVAILABLE FINISHES

Premium polyester paint ★★★★★☆

Group I	NEW	NEW	
	White MAT	Grey MAT	Structured anthracite
Group II	White	Grey	Brown

STEEL EI 30 AND EI 60 - INDICATIONS FOR USE:

- public buildings
- hotels, guesthouses
- boiler rooms
- garages



Custom colours available through Porta CONTRACT, details regarding bespoke orders, see page 226.



hinge adjustment +/-3 mm



mortise cylinder lock, set includes a handle

TECHNICAL INFORMATION

ACCESSORIES INCLUDED IN THE DOOR LEAF PRICE

- 2PCs of three-part hinges. One is load-bearing, another, thanks to a spring in it, enables door to self-closing.
- A mortise cylinder lock
- Dog bolt (1 PCs for EI 30, 2 PCs for EI 60)
- A set of handles with escutcheons (order separately)
- Transparent, fireproof glass panel

DOOR FRAMES

- Corner profile steel frame. 84 mm profile (EI 30) and 110 mm profile (EI 60)
- Made out of both sides hot-dip galvanized steel, 1,5 mm thick. Welded joint of frame corners. Equipped with stainless steel threshold (type 1), astragal and an intumescent seal.
- A door frame can be ordered in two options:
 - to install on a finished floor level - '0'; threshold at an additional charge (EI 30 and EI 60)
 - to install below a floor level - '-30'; threshold at an additional charge (EI 30 and EI 60)

NOTES

- **Steel doors EI 30, EI 60 - Technical Assessment AT-15-7236/2016, ITB Warsaw.**
- in case of using different hardware to offered by PORTA, guarantee cards guidelines must be followed
- In order to meet the requirements of external use, glazed models have to be equipped with a glass panel with special parameters - price and production time to be agreed with Porta 'CONTRACT' (see page 226).

EXTRA CHARGES

- size '100' (EI 30)
- size '100' (EI 60)
- colours - GROUP II
- fireproof door viewer
- a stainless steel threshold (EI 30)
- a reinforcement for an additional door closer

DOOR FRAMES

There is no complete door set without a door frame. For each of offered door leaf we recommend door frame which is suitable for the door you choose, both technically and aesthetically.





FIXED DOOR FRAME. REBATED

Door frames recommended for interiors where adjustments to a wall is not required.

Door frames of 100 mm profile are compatible with any door leaf.

Door frames of 60 mm profile are compatible with door leaves finished with Portadecor and Portasynchro 3D veneers.

AVAILABLE FINISHES

Portadecor
Portasynchro 3D

★★★

Portadur
Premium veneer
Natural Select
Natural Oak, Walnut, Ash
Natural Oak Satin
UV acrylic paint

★★★★

Portaperfect 3D
Portalamino
CPL HQ 0,2 mm
Gladstone/Halifax

★★★★★

Finishes charts see page 217 – 224.

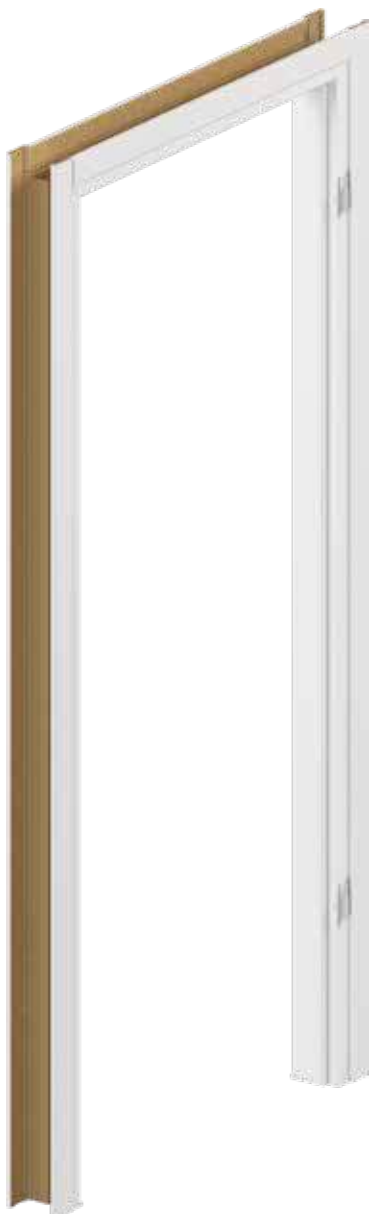

DOOR FRAME - CROSS SECTION



60 mm,
basic option
without architraves



60 mm,
synthetic veneer
(with architraves)



100 mm synthetic veneer
(architraves joined at 90° angle)
or natural veneers (architraves
joined at 45° angle)



100 mm,
synthetic or natural veneer
(with rounded architraves)

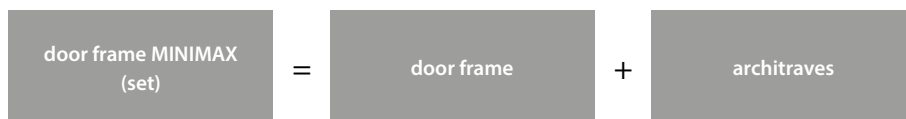

Door frames, architraves and quaterrounds are also available in a synthetic veneer for self-painting.

TECHNICAL INFORMATION

DOOR FRAME CONSTRUCTION

A door frame consists of:

- Door frame head and two jambs, made of MDF, with hardware and accessories
- Architraves (at an additional charge)
- Quater round (at an additional charge)
- Door frame is produced and delivered as a set of elements to assemble on site. MINIMAX door frame for Porta GRANDE door leaf is finished with primer foil and paint hardened under UV lamp.

ACCESSORIES- IN THE PRICE OF MINIMAX 60 MM

(available only in Portadecor and Portasynchro 3D finishes)

- two or three standard barrel hinges or PRIME hinges at an extra charge
- Three hinges for size '100'
- Door stops
- Dowel pins, hole plugs
- Humidity protecting plugs for bottom part of a door frame

ACCESSORIES- IN THE PRICE OF MINIMAX 100 MM

Synthetics veneers:

- Two or three standard barrel hinges or PRIME hinges at an extra charge
- Three hinges for size '100' and all sizes of a door frames finished with Portadur veneer

Natural veneers:

- Three PRIME hinges
- Three sets of PRIME hinges for size '90' and '100'
- A rubber seal set circumferentially
- Humidity protecting plugs for bottom part of a door frame

DOOR FRAME SIZE, SEE PAGE 210 TABLE 1

Profile width 60 mm and 100 mm

Available sizes '60', '70', '80', '90' and '100', and any combination of these sizes for double leaf doors.

NOTES

- Technical Assessment ITB-KOT-2018/0358, issue 1
- Door frames should be installed on finished walls (e.g. wall papers) and on a finished floor (e.g. floor panels)
- 100 mm door frame is also available in a 'tunnel' option (without a rebate, a seal, hinges or a strike plate)
- Door frames and architraves are available in unpainted option (for self-finishing).

EXTRA CHARGES

- door frame: CPL 0,2 mm finish - GROUP II
- door frame: Natural veneer: Walnut
- door frame: Natural veneer, White Oak, Satin
- architraves: Natural veneer, White Oak, Satin
- quaterround: Natural veneer, White Oak, Satin
- PRIME hinges

Porta SYSTEM, Porta SYSTEM GK

PORTA SYSTEM

Adjustable door frame with architraves - 60 or 80 mm. Porta System is easy to install and it is compatible with all of internal door leaves. Thanks to the availability of the Retro Module you can achieve completely new and very different door styling.

PORTA SYSTEM GK

Adjustable door frame for glass door leaves, produced in Polish Norm. Only such a set guarantees high performance and satisfaction with your purchase.

AVAILABLE FINISHES

Portadecor ★★★
Portasynchro 3D

Portadur ★★★★★
Premium veneer
Natural Select
Natural Oak, Walnut, Ash
Natural Oak Satin
UV acrylic paint

Portaperfect 3D ★★★★★
Portalamino
CPL HQ 0,2 mm
Gladstone/Halifax

Finishes charts see page 217 – 224.



DOOR FRAME - CROSS SECTION

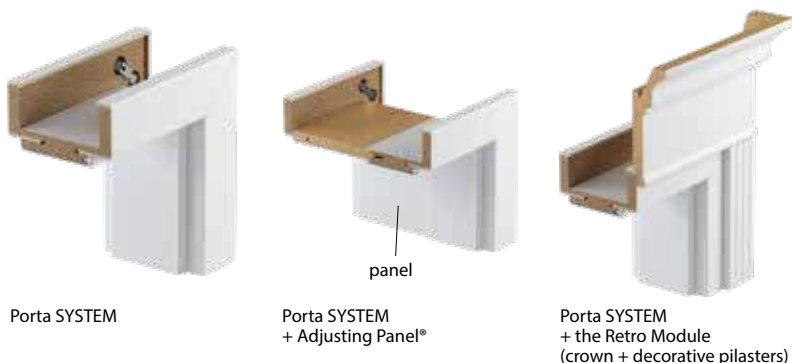

ADJUSTMENT RANGE

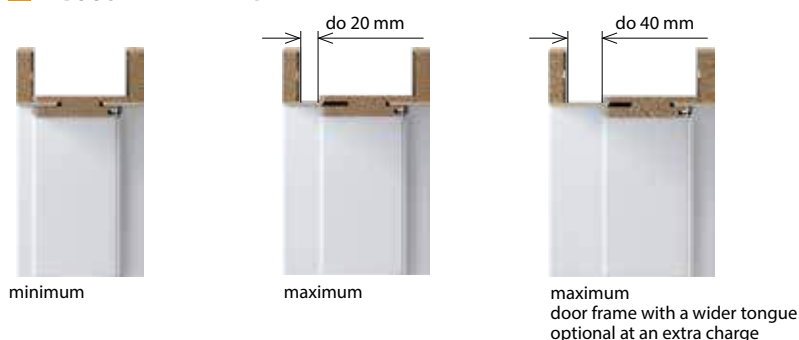

ADJUSTING PANEL WIDTH

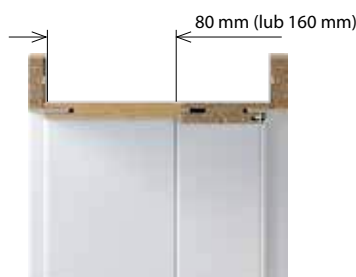

Installation of Porta SYSTEM, see video:
<https://www.youtube.com/watch?v=w71vINxFgZY>

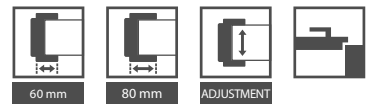

ADJUSTMENT RANGES

A	75 ÷ 95
B	95 ÷ 115
C	120 ÷ 140
D	140 ÷ 160
E	160 ÷ 180
F	180 ÷ 200
G	200 ÷ 220
H	220 ÷ 240
I	240 ÷ 260
J	260 ÷ 280
K	280 ÷ 300



TECHNICAL INFORMATION

DOOR FRAME CONSTRUCTION

A door frame consists of:

- A door frame head and two jambs, made of wood-based material. It comes with hardware and accessories
- Architraves (60, 80 mm).

The door frame is produced and delivered as a set of elements to be assembled on site. PORTA SYSTEM door frame for Porta GRANDE door leaf is finished with primer foil and paint hardened under UV lamp.

ACCESSORIES IN THE PRICE A DOOR FRAME

Porta SYSTEM

Synthetic veneers:

- Two or three standard barrel hinges or PRIME hinges at an extra charge
- Three hinges for size '100' and all sizes of a door frames finished with Portadur veneer
- A rubber seal set circumferentially

Natural veneers:

- Two or three PRIME hinges
- Three sets of PRIME hinges for size '90' and '100' and all sizes of a door frames finished with a natural veneer 'Select'
- A rubber seal set circumferentially

Porta SYSTEM GK

- A strike plate (small)
- A rubber seal set circumferentially
- Hinge receivers, 2 PCs for size '60'-'90'; 3 PCs for size '100'

NOTE! Hinges are not included in a door frame set.

DOOR FRAME SIZE, SEE PAGE 210, TABLE 1

Porta SYSTEM

- Wall thicknesses (A-K) '60', '70', '80', '90', '100', '110', and '120'-'200' and single leaf '60'-'90' with a side panel '40'*

Porta SYSTEM GK

- Wall thicknesses (A-K) '60', '70', '80', '90', '100'

NOTES

- Technical Assessment ITB-KOT-2018/0358, issue 1
- Door frames should be installed on finished walls (e.g. wall papers) and on a finished floor (e.g. floor panels)
- 100 mm door frame is also available in a „tunnel“ option (without a rebate, a seal, hinges or a strike plate)
- Module RETRO is not available in following finishes: CPL HQ, Premium veneer and Gladstone/Halifax.
- **PORTA SYSTEM TRANSOMS- information available on porta.com.pl/do-pobrania.**

EXTRA CHARGES

- door frame: CPL 0,2 mm finish - GROUP II
- door frame: Natural veneer: Walnut
- door frame: Natural veneer, White Oak, Satin
- adjusting panel: Natural veneer, White Oak, Satin
- crown: Natural veneer, White Oak, Satin
- decorative pilasters: Natural veneer, White Oak, Satin
- PRIME hinges
- reinforcement for a door closer
- electric strike: fail safe or fail secure

(see 207)

Porta SYSTEM ELEGANCE

ADJUSTABLE DOOR FRAME WITH 80 MM ARCHITRAVES. NON-REBATED.

Internal door frame which is compatible with non-rebated door leaves. Easy to install.

AVAILABLE FINISHES

Portadecor ★★★
Portasynchro 3D

Portadur ★★★★★
Premium veneer
Natural Select
Natural Oak, Walnut, Ash
Natural Oak Satin
UV acrylic paint

Portaperfect 3D ★★★★★
Portalamino
CPL HQ 0,2 mm
Gladstone/Halifax

Finishes charts see page 217 – 224.



DOOR FRAME - CROSS SECTION



A PAINTED DOOR FRAME IS DEDICATED FOR GRANDE DOOR LEAF COLLECTION

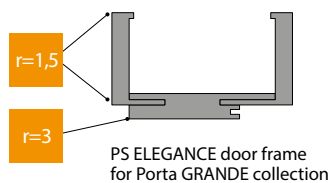

NOTE: If the back of the hinge does not fit in a wall opening, a little wall chasing has to be made. See the drawing see p. 208



How to install and adjust 3D hinge:
<https://www.youtube.com/watch?v=2vavrJrZ9Kc>

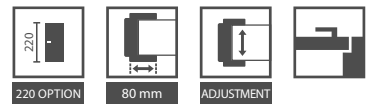

ADJUSTMENT RANGES

B	95 ÷ 115
C	120 ÷ 140
D	140 ÷ 160
E	160 ÷ 180
F	180 ÷ 200
G	200 ÷ 220
H	220 ÷ 240
I	240 ÷ 260
J	260 ÷ 280
K	280 ÷ 300



3D hinge (closed door)



3D hinge (opened door)

KEY FEATURES OF THE NEW SIMONSWERK 3D HINGE:

- CONVENIENT 3DADJUSTMENT
- 200.000 TEST CYCLES IN CONTINUOUS OPERATION
- LOAD CAPACITY 60 KG (2 HINGES),
- ALL VISIBLE ELEMENTS ARE FINISHED WITH POLYESTER COATING

WE RECOMMEND!

SKIRTINGS BOARDS FINISHED WITH UV ACRYLIC PAINT
see page 206

TECHNICAL INFORMATION

DOOR FRAME CONSTRUCTION

A door frame consists of:

- A door frame head and two jambs, made of wood-based material. It comes with hardware and accessories
- Architraves 80 mm
- Architrave edge radius, arsis, for natural veneers Standard, Select, Satin.
- Architrave edge radius 1,5 mm for synthetic finishes: Portadecor, Portasynchro 3D, Portadur and Portaperfect 3D. 3mm radius for CPL HQ 0,2 mm.
- PS ELEGANCE is produced and delivered as a set of elements to assemble on site.
- PS ELEGANCE door frame for Porta GRANDE door leaf is finished with primer foil and paint hardened under UV lamp.

ACCESSORIES- IN THE PRICE A DOOR FRAME

- Two sets of adjustable 3D hinges
- A rubber seal set circumferentially

DOOR FRAME SIZE, SEE PAGE 210, TABLE 1

- Ten adjustment ranges from 95 mm to 300 mm; '60', '70', '80', '90', '100', and '120'-'200

NOTES

- Technical Assessment ITB-KOT-2018/0358, issue 1
- Size '100' requires third hinge
- Door frames should be installed on finished walls (e.g. wall papers) and on a finished floor (e.g. floor panels)
- 100 mm door frame is also available in a 'tunnel' option (without a rebate, a seal, hinges or a strike plate)
- Height 220 cm is available only with natural veneer.
- Third hinge - standard.

EXTRA CHARGES

- door frame: CPL 0,2 mm finish - GROUP II
- door frame: Natural veneer: Walnut
- door frame: Natural veneer, White Oak, Satin
- gold 3D hinges (extra charge added to a door frame price)
- third 3D hinge - silver (an extra charge added to a door frame price)
- third 3D hinge - gold (an extra charge added to a door frame price)
- reinforcement for a door closer
- height 220 cm
- architraves 100 mm (apply to height 220 cm)

LEVEL

UNIQUE AND INNOVATIVE ADJUSTABLE DOOR FRAME

Adjustable door frame with 80 mm architraves.
Non-rebated with an upper panel
- 20 or 100 cm high.

AVAILABLE FINISHES

Portadecor
Portasynchro 3D ★★★

Premium veneer
UV acrylic paint ★★★★★

Portaperfect 3D
Portalamino ★★★★★

Finishes charts see page 217 – 224.

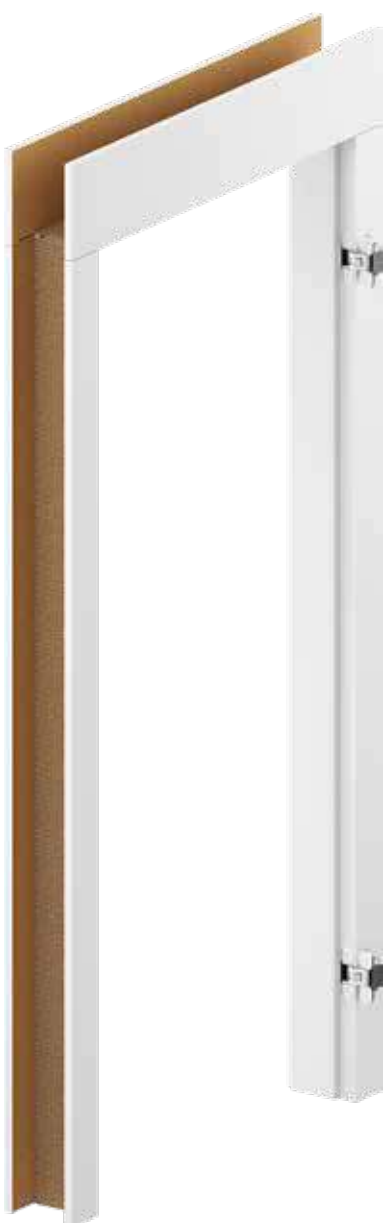

DOOR FRAME - CROSS SECTION

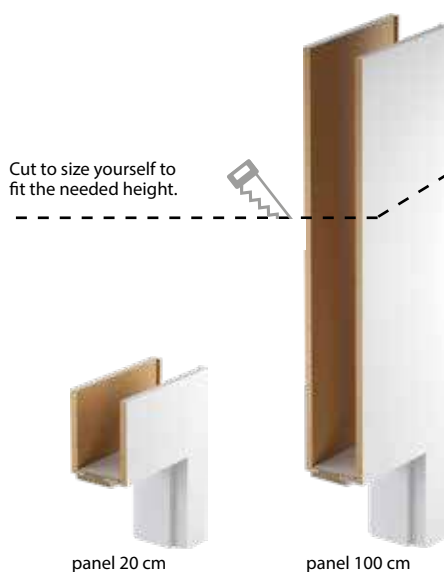

DOOR FRAME - CROSS SECTION

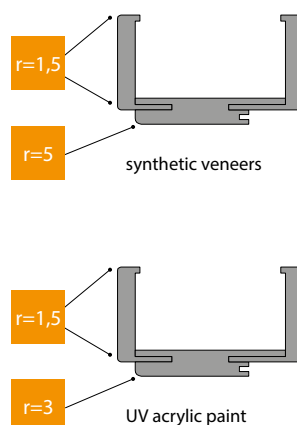

ADJUSTMENT RANGE

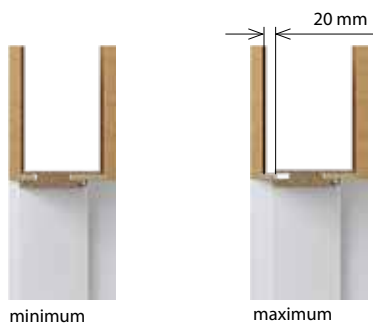

NOTE: If the back of the hinge does not fit in a wall opening, a little wall chasing has to be done. see p. 208



ADJUSTMENT RANGES

B	95 ÷ 115
C	120 ÷ 140
D	140 ÷ 160
E	160 ÷ 180
F	180 ÷ 200
G	200 ÷ 220
H	220 ÷ 240
I	240 ÷ 260
J	260 ÷ 280
K	280 ÷ 300

UPPER PANELS

200 mm (2x)

1000 mm (2x)

200 and 1000 mm (1/1)

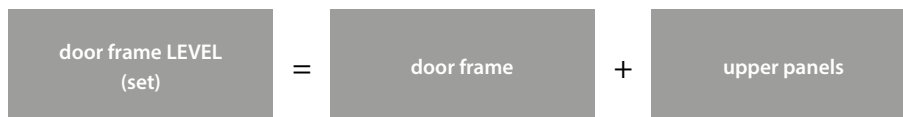

Installation of LEVEL door frame, see video:
www.porta.com.pl/dm/montazosclevelevel.wmv



Door frame for a double-leaf door and/or finished with CPL HQ - order through Porta CONTRACT, see page 226.

KEY FEATURES OF THE NEW SIMONSWERK 3D HINGE:

- CONVENIENT 3DADJUSTMENT
- 200.000 TEST CYCLES IN CONTINUOUS OPERATION
- LOAD CAPACITY 60 KG (2 HINGES),
- ALL VISIBLE ELEMENTS ARE FINISHED WITH POLYESTER COATING

WE RECOMMEND!

SKIRTINGS BOARDS FINISHED WITH UV ACRYLIC PAINT
 see page 206

TECHNICAL INFORMATION

DOOR FRAME CONSTRUCTION

A door frame consists of:

- A door frame head and two jambs, made of wood-based material. It comes with hardware and accessories
- Architraves 80 mm
- Two vertical panels (order separately)
- Vertical grain direction for a LEVEL panel. For chosen finishes horizontal grain direction available (see p. 84)
- Architrave edge radius - 1,5 mm. LEVEL door frame is produced and delivered as a set of elements to be assembled on site. LEVEL door frame for UV painted door leaves is finished with primer foil and paint hardened under UV lamp.

ACCESSORIES- INCLUDED IN DOOR FRAME PRICE

- Two sets of adjustable 3D hinges
- A rubber seal set circumferentially

DOOR FRAME SIZE, SEE PAGE 210, TABLE 1

Ten adjustment ranges from 95 mm to 300 mm; '60', '70', '80', '90', '100'

NOTES

- Technical Assessment ITB-KOT-2018/0358, issue 1
- Door frames should be installed on finished walls (e.g. wall papers) and on a finished floor (e.g. floor panels)
- Door frame is also available in a 'tunnel' option (without a rebate, a seal, hinges or a strike plate)

EXTRA CHARGES

- gold 3D hinges (extra charge added to a door frame price)
- third 3D hinge - silver (an extra charge added to a door frame price)
- third 3D hinge - gold (an extra charge added to a door frame price)

Porta RENOVA

STEEL DOOR FRAME CASING SYSTEM

Give your apartment unique character. This solution gives you the possibility to change doors without dismantling the old door frame.

AVAILABLE FINISHES

Portadecor
Portasynchro 3D ★★★

Portadur
Premium veneer ★★★★★

Portaperfect 3D
Portalamino
CPL HQ 0,2 mm ★★★★★

Finishes charts see page 217 – 224.

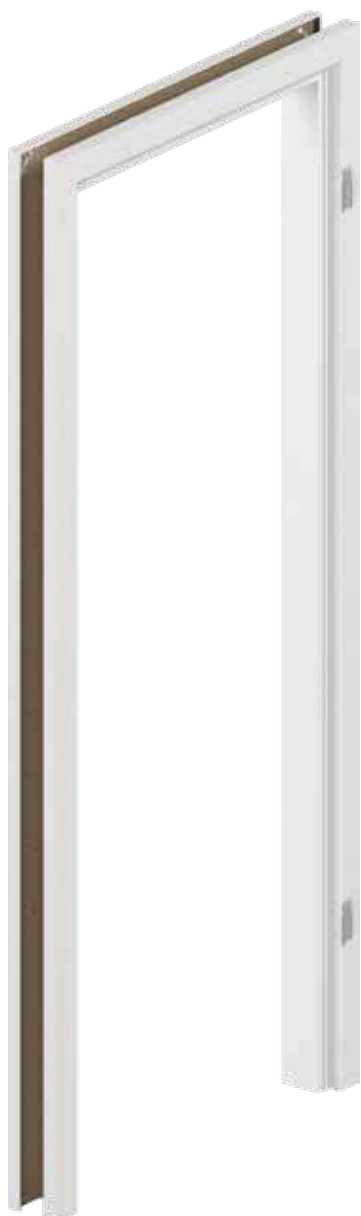

DOOR FRAME - CROSS SECTION



ADJUSTMENT RANGE

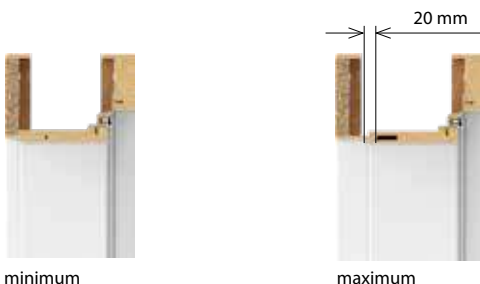

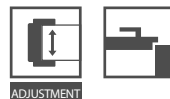

ADJUSTMENT RANGES

S	55 ÷ 75
A	75 ÷ 95
B	95 ÷ 115
C	120 ÷ 140
D	140 ÷ 160
E	160 ÷ 180
F	180 ÷ 200
G	200 ÷ 220
H	220 ÷ 240
I	240 ÷ 260
J	260 ÷ 280

PORTA RENOVA OFFER INCLUDES:

- Porta RENOVA door frame, adjustment range from 'A' to 'J' + size 'S' 55-75 mm
- 'tunnel' option, adjustment range from 'A' to 'J'
- head and jambs with a tongue (broadening PORTA RENOVA adjustment) from 'A' to 'J'

TECHNICAL INFORMATION

DOOR FRAME CONSTRUCTION

A door frame consists of:

- A door frame head and two jambs, made of wood-based materials
- Architraves
- Architrave edge radius 'arris', for natural veneers Standard, Select, Satin.
- Porta RENOVA is produced and delivered as a set of elements to assemble on site.

ACCESSORIES INCLUDED IN DOOR FRAME PRICE

- Two standard barrel hinges
- Three standard barrel hinges for size '100'-'110' and all sizes of a door frames finished with Portadur veneer

DOOR FRAME SIZE, SEE PAGE 210, TABLE 1

- For adjustment ranges ('S' + A-J) '60', '70', '80', '90', '100', '110'.

NOTES

- RENOVA door frame is available with Individual Approval Documentation
- Door frames should be installed on finished walls (e.g. wall papers) and on a finished floor (e.g. floor panels)
- Door frame is also available in a 'tunnel' option (without a rebate, a seal, hinges or a strike plate)
- Additional broadening (head and jambs)
- The door frame is compatible with standard door leaves. If client chooses a handle with an escutcheon wider than 44 mm, they have to order a door leaf with a 60 mm lock.
- All crooks and unevenness of a wall and old door frame have to be taken into consideration during wall opening measurement.

Villadora RETRO, MODERN

ADJUSTABLE DOOR FRAME, RETRO'

Internal adjustable door frame dedicated for the Villadora RETRO door leaves.

ADJUSTABLE NON-REBATED DOOR FRAME MODERN

Internal adjustable door frame dedicated for the Villadora MODERN door leaves.

AVAILABLE FINISHES

Natural Oak Satin

★★★★

Finishes charts see page 217 – 224.

Natural Select
Natural Oak, Ash, Walnut
Natural Oak Satin

★★★★

Finishes charts see page 217 – 224.



DOOR FRAME - CROSS SECTION VILLADORA RETRO



door frame profile - wide architrave 80 mm



The Retro module. (crown and pilasters)

VILLADORA MODERN NON-REBATED DOOR FRAME - CROSS-SECTION



door frame profile
- architrave 80 mm for door height 200
- architrave 100 mm for door height 220

'PLUS' upper panel
upper architrave 200 mm
(note: in STANDARD option elements joint under 45°, read description see p. 169)

NOTE: If the back of the hinge does not fit in a wall opening, a little wall chasing has to be made. See the drawing see p. 208

ADJUSTMENT RANGE



minimum



maximum

ADJUSTMENT RANGES

A	75 ÷ 95 mm
B	95 ÷ 115 mm
C	120 ÷ 140 mm
D	140 ÷ 160 mm
E	160 ÷ 180 mm
F	180 ÷ 200 mm
G	200 ÷ 220 mm
H	220 ÷ 240 mm
I	240 ÷ 260 mm
J	260 ÷ 280 mm
K	280 ÷ 300 mm



TECHNICAL INFORMATION

VILLADORA RETRO

DOOR FRAME CONSTRUCTION

A door frame consists of:

- A door frame head and two jambs, made of wood-based material. It comes with hardware and accessories
- Architraves

Villadora RETRO is produced and delivered as a set of elements to be assembled on site.

ACCESSORIES INCLUDED IN DOOR FRAME PRICE

- Three sets of adjustable barrel hinges (3D)
- A rubber seal set circumferentially

DOOR FRAME SIZE, SEE PAGE 210, TABLE 1

Adjustment ranges (A-K): '60', '70', '80', '90', '100' and '120' ÷ '200'.

NOTES

- Technical Assessment ITB-KOT-2018/0358, issue 1
- Door frames should be installed on finished walls (e.g. wall papers) and on a finished floor (e.g. floor panels)
- Module RETRO is available for Villadora RETRO door frames.

VILLADORA MODERN

DOOR FRAME CONSTRUCTION

A door frame consists of:

- A door frame head and two jambs, made of wood-based material. It comes with hardware and accessories
- Architraves
- 2 vertical architraves (panels). 'PLUS' version.

We offer four construction types:

- 80 mm architraves (height 200 STANDARD), or 100 mm architraves (height 220 STANDARD), head, jambs and architraves ripped at 45°
- 80 mm architraves (height 200 PLUS), or 100 mm architraves (height 220 PLUS), head, jambs and architraves ripped at 90°

Edge profile of architraves, panels, head and jambs- sharp arris.

Villadora RETRO is produced and delivered as a set of elements to assemble on site.

ACCESSORIES INCLUDED IN DOOR FRAME PRICE

- Three sets of adjustable 3D hinges for height 200 and 220 (STD. width)
- A rubber seal set circumferentially

DOOR FRAME SIZE, SEE PAGE 210, TABLE 1

Wall thicknesses (B-K): '60', '70', '80', '90', '100' and '120' ÷ '200'.

NOTES

- Technical Assessment ITB-KOT-2018/0358, issue 1
- Door frames should be installed on finished walls (e.g. wall papers) and on a finished floor (e.g. floor panels)
- **Please consider hinge receivers during wall opening measurement, see Manual**

EXTRA CHARGES

- MODERN door frame: White Oak, Satin
- MODERN door frame: Natural veneer: Walnut
- MODERN door frame in PLUS option

DOOR FRAMES STEEL

PORTASTEEL
PRODUCTS

LONG LASTING
DURABILITY



QUALITY
GUARANTEED

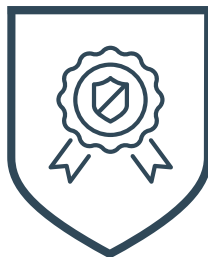

MODERN
DESIGN

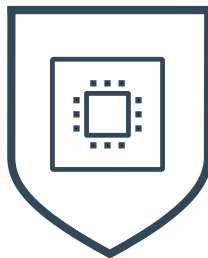

EASY
INSTALLATION





- we use galvanized steel sheets for all of our steel products
- high quality Premium coatings
- various finishes: polyester paint, stainless steel, PVC laminated steel sheet, coated steel sheet
- tested for the highest durability
- to use for internal doors, technical doors, apartment entrance doors and external doors

- each product is precisely made
- long lasting corrosion protection
- 18 years experience in producing steel products
- high performance and technical parameters

- highly functional and aesthetically pleasing
- a wide range of colours of the highest quality Premium Polyester Paints
- surface: matt, gloss, textured
- ‚made to order‘ products available – according to architectural design
- suitable for public buildings, residential buildings, schools, shopping centres, underground car parks

- quick and easy installation
- produced to the required standards
- accessories improving door functionality
- suitable for installation to masonry, concrete and plasterboard

Steel Porta SYSTEM

INTERNAL STEEL DOOR FRAME

Adjustable steel door frame.

It has the same advantages as wooden Porta System door frame when it comes to installation, design and adjustment.

At the same time steel construction and galvanic-varnished surface protection makes this product perfect for use in demanding areas with increased humidity or temperature changes.

Ideal as an internal door frame for use in residential buildings.

AVAILABLE FINISHES

Prime paint

★★★★

Premium polyester paint

★★★★★

Finishes charts see page 217 – 224.



15^{*}
YEAR
WARRANTY

P

GALVANIZED
SHEET

PORTA STEEL
PRODUCT

PROTECTION SYSTEM OF STEEL SURFACES

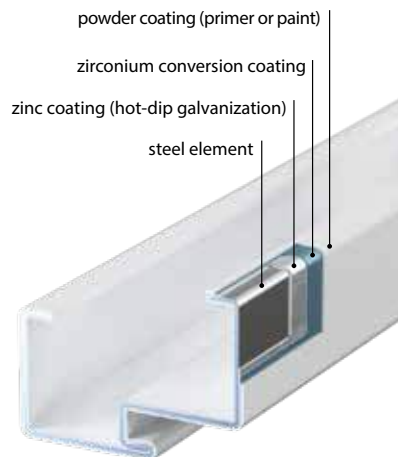

DOOR FRAME - CROSS SECTION STEEL PORTA SYSTEM

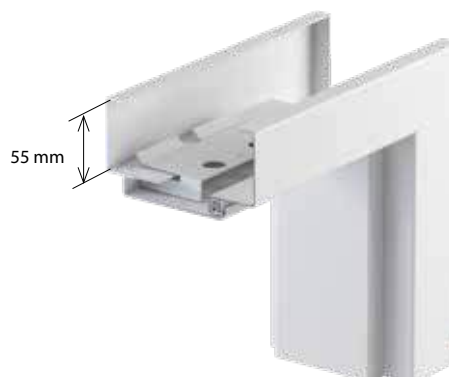

*<https://www.porta.com.pl/dm/warranty15.pdf>



LONG LASTING DURABILITY



QUALITY GUARANTEED



MODERN DESIGN



EASY INSTALLATION



ADJUSTMENT

AVAILABLE FINISHES

Premium polyester paint ★★★★★☆

Group I	NEW White MAT	NEW Grey MAT	Structured anthracite
	NEW Beige MAT	NEW Brown MAT	Anthracite HPL/CPL
Group III	NEW Black MAT		

WALL THICKNESSES

A	95 ÷ 120 mm
B	120 ÷ 145 mm
C	145 ÷ 170 mm
D	170 ÷ 195 mm

STEEL PORTA SYSTEM - ADJUSTMENT RANGES

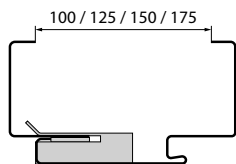

HOW TO ADJUST PORTA SYSTEM STEEL DOOR FRAME

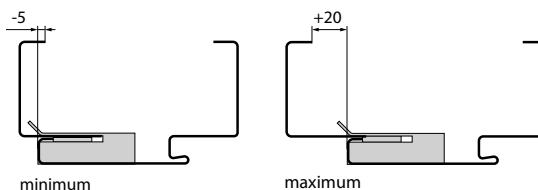

OUR PRODUCTS ARE DISTINGUISHED BY:

- THE HIGHEST QUALITY OF GALVANIZED STEEL
- MATERIAL ENDURANCE
- WIDE PROFILES RANGE OF CORNER PROFILE DOOR FRAMES AND ADJUSTABLE DOOR FRAMES
- HIGH DURABILITY
- HIGH AESTHETICS VALUES

ONE DOOR FRAME, MANY ADVANTAGES:

- COMPATIBLE WITH ANY OF PORTA DOOR LEAVES
- ADJUSTMENT RANGES FOR MANY WALL THICKNESSES
- REINFORCED LOCK STRIKE
- EASY ANCHORING REGARDLESS THE TYPE OF WALL

TECHNICAL INFORMATION

DOOR FRAME CONSTRUCTION

This adjustable door frame is made out of the best quality galvanized steel, 1,2 mm thick.

A door frame consists of:

- Two or three standard barrel hinges
- Three hinges (size '100')
- An allen key
- A rubber seal available in following colours: white, grey, brown, beige and anthracite
- An anchoring plate
- Reinforcement for the lock strike

ACCESSORIES INCLUDED IN DOOR FRAME PRICE

- Two or three standard barrel hinges
- Three hinges (size '100')
- An allen key
- A rubber seal available in following colours: white, grey, brown, beige and anthracite
- An anchoring plate
- Reinforcement for the lock strike

DOOR FRAME SIZE, SEE PAGE 210, TABLE 2

- '60', '70', '80', '90', '100' and '120' ÷ '200'
- To be installed on a finished floor level '0'.

NOTES

- Technical Assessment ITB-KOT-2017/0245 issue 1.
- Certificate of conformity no. ITB-2617/W, ITB Warsaw.
- Door frames should be installed on finished walls (e.g. wall papers) and on a finished floor (e.g. floor panels).
- Polyester Premium paint Anthracite HPL/CPL id dedicated for door leaves finished with HPL/CPL Anthracite.
- Size '80' and '90' in the Investment Norm' (clear opening width 800, 900 mm) available as a standard - without an extra charge.

EXTRA CHARGES

- door frame: black
- reinforcement for a door closer
- stainless steel threshold

(see p. 207)

Adjustable. Adjustable PS with ,sharp edges'

INTERNAL STEEL DOOR FRAME

Main benefits of these products are: precise design of all elements and easy installation as well as value for money.

Adjustment feature allows for installation to almost any wall width. The door frame can be used in virtually all types of buildings: apartments, offices, hotels, factories, industrial buildings and any other place where high durability is require.

TOP
INVESTMENT
COLLECTIONS

AVAILABLE FINISHES

Prime paint ★★★★★

Premium polyester paint ★★★★★

Finishes charts see page 217 – 224.

PROTECTION SYSTEM OF STEEL SURFACES

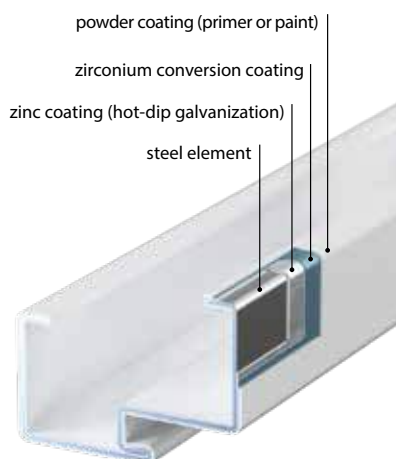

OUR PRODUCTS ARE DISTINGUISHED BY:

- THE HIGHEST QUALITY OF GALVANIZED STEEL
- MATERIAL ENDURANCE
- HIGH DURABILITY
- HIGH AESTHETICS VALUES



You will find more information in the catalogue of
STEEL DOOR FRAMES
porta.com.pl/do-pobrania



GALVANIZED
SHEET

PORTA STEEL
PRODUCT





LONG LASTING
DURABILITY



QUALITY
GUARANTEED



MODERN
DESIGN



EASY
INSTALLATION



ADJUSTMENT



Adjustable

WALL THICKNESSES

A	95 ÷ 120 mm
B	121 ÷ 145 mm
C	146 ÷ 170 mm
D	171 ÷ 195 mm
E	196 ÷ 220 mm
F	221 ÷ 245 mm
G	246 ÷ 270 mm
H	271 ÷ 295 mm

Adjustable PS with 'sharp edges'

WALL THICKNESSES

A	95 ÷ 120 mm
B	121 ÷ 145 mm
C	146 ÷ 170 mm
D	171 ÷ 195 mm
E	196 ÷ 220 mm
F	221 ÷ 245 mm
G	246 ÷ 270 mm
H	271 ÷ 295 mm

DOOR FRAME - CROSS SECTION

Adjustable door frame

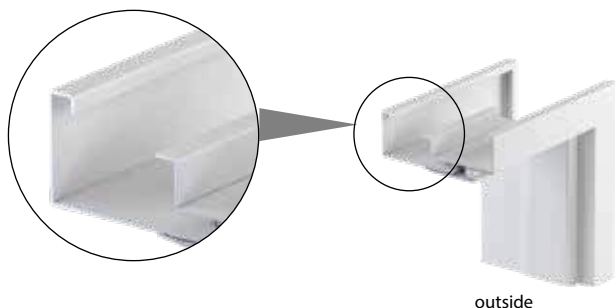

outside

Adjustable door frame with 'sharp edges'

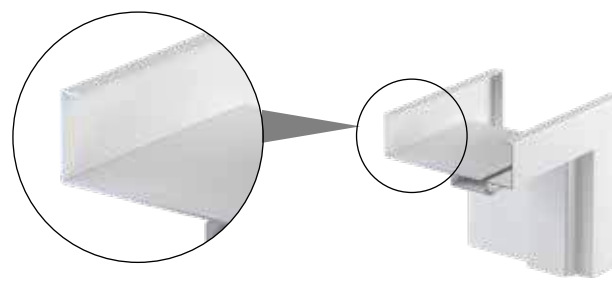

inside

TECHNICAL INFORMATION

DOOR FRAME CONSTRUCTION

This adjustable door frame is made out of the best quality galvanized steel, 1,5 mm thick (the Adjustable) or 1,2 mm thick (the Adjustable with 'sharp edges').

A door frame consists of:

- fixed part mounted on a wall (with hinges and lock strike)
- adjustable part, wrapping the wall
- a rubber seal set circumferentially
- barrel hinges

ACCESSORIES INCLUDED IN DOOR FRAME PRICE

- Two or three standard barrel hinges
- Three hinges (size '100' and '110')
- An allen key
- A rubber seal available in following colours: white, grey, brown, beige and anthracite
- Rawlplugs - for a door frame anchored to a concrete wall
- Self-tapping screws - for a door frame anchored to a plasterboard wall

DOOR FRAME SIZE, SEE PAGE 210, TABLE 2

- '60'; '70'; '80'; '90'; '100'; '110' and '120' ÷ '200'
- To be installed on a finished floor level '0'.

NOTES

- Technical Assessment ITB-KOT-2017/0245 issue 1.
- Certificate of conformity no. ITB-2617/W, ITB Warsaw
- Door frames should be installed on finished walls (e.g. wall papers) and on a finished floor (e.g. floor panels)
- **Polyester Premium paint Anthracite HPL/CPL id dedicated for door leaves finished with HPL/CPL Anthracite**
- **Size '80' and '90' in the 'Investment Norm' (clear opening width 800, 900 mm) available as a standard - without an extra charge.**

EXTRA CHARGES

- colours: group II
- door frame: black
- adjustable lock strike
- reinforcement for a door closer
- stainless steel threshold
- electric strike: fail safe or fail secure

(see p. 207)
(see p. 207)

Corner profile frame - SMALL PLUS, LARGE, FOLDING LARGE

INTERNAL STEEL DOOR FRAMES

Thanks to the highest world standards, the latest technologies and excellent materials we produce galvanized steel or stainless steel door frames. These are the highest quality products which are often used when robust doors are required. Thanks to the powder coating process used during production, the surface of the steel sheet is perfectly smooth and protected against corrosion.

TOP
INVESTMENT
COLLECTIONS

AVAILABLE FINISHES

Prime paint	★★★★
Premium polyester paint Laminated steel sheet (PVC)	★★★★★
Stainless steel	★★★★★

Finishes charts see page 217 – 224.



P
GALVANIZED
SHEET
PORTA STEEL
PRODUCT

PROTECTION SYSTEM OF STEEL SURFACES

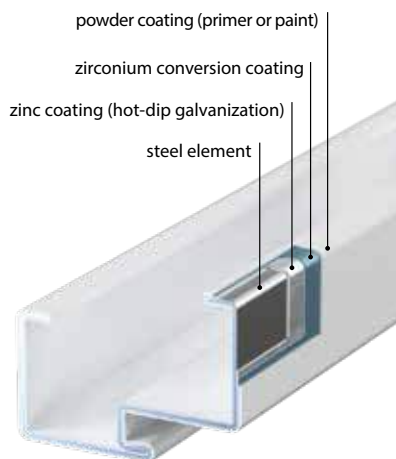

OUR PRODUCTS ARE DISTINGUISHED BY:

- THE HIGHEST QUALITY OF GALVANIZED STEEL
- MATERIAL ENDURANCE
- HIGH DURABILITY
- HIGH AESTHETICS VALUES



You will find more information in the catalogue of STEEL DOOR FRAMES
porta.com.pl/do-pobrania



DOOR FRAME - CROSS SECTION



Corner profile frame
- SMALL PLUS



Corner profile frame
- LARGE



Corner profile folding frame
- LARGE



Corner profile stainless steel frame
- LARGE

TECHNICAL INFORMATION

DOOR FRAME CONSTRUCTION

Profile corner door frames (LARGE and SMALL PLUS) are made out of galvanized steel, 1,2 mm thick. They are available as reversible door frames or as right/left door frames. Profile width: 64 mm (SMALL PLUS) and 105 mm (LARGE). The door frames can be also made of: brushed stainless steel (100 mm profile) or galvanized steel film laminated PVC (80 mm profile). Folding door frames are produced and delivered as a set of elements to be assembled on site.

ACCESSORIES INCLUDED IN DOOR FRAME PRICE

'LARGE', 'SMALL PLUS', and Folding door frame for concrete walls:

- Two or three standard barrel hinges
- Three hinges (size '100' and '110')
- An allen key
- A rubber seal set circumferentially. Colours: white, grey, brown, beige and anthracite
- Special anchors to ease an installation (SMALL PLUS)

'LARGE' for plasterboard walls:

- Two or three standard barrel hinges
- Three hinges (size '100' and '110')
- An allen key
- A rubber seal available in following colours: white, grey, brown, beige and anthracite
- Special anchors to ease an installation (max. for a wall width 150 mm)

DOOR FRAME SIZE, SEE PAGE 210, TABLE 2

- '60', '70', '80', '90', '100', '110' and '120' ÷ '200'¹

Two options:

- To be installed on a finished floor level - '0'
- To be installed under floor level - '-30'

NOTES

- Technical Assessment ITB-KOT-2017/0245 issue 1.
- Certificate of conformity no. ITB-2617/W, ITB Warsaw
- Profile 80 of folding door frame finished with PVC, cannot be broaden
- Polyester Premium paint Anthracite HPL/CPL id dedicated for door leaves finished with HPL/CPL Anthracite

EXTRA CHARGES

- colours: GROUP II
- door frame: black
- adjustable lock strike (LARGE)
- dowel pins (LARGE)
- door frame profile extension from 110 to 150 mm
- door frame profile extension from 155 mm to 270 mm
- door frame profile extension from 275 to 390 mm
- reinforcement for a door closer
- stainless steel threshold
- electric strike: fail secure or fail safe

(see p. 207)
(see p. 207)

¹ Dimensions are not available for stainless steel corner profile frame SMALL PLUS

PROJECT BIS, PROJECT Premium®

® Porta proprietary solution, all rights reserved

TOP
INVESTMENT
COLLECTIONS

DOOR FRAME COVER FOR APARTMENT ENTRANCE DOORS.

Considering aesthetically pleasing design of various rooms, we have complemented our offer with PROJECT BIS and PROJECT Premium steel door frame covers.

Thanks to a specially designed profile of a steel door frame, the cover can be easily installed. Covers match the door leaf and facades.

AVAILABLE FINISHES

Portasynchro 3D

★★★

Portaperfect 3D
CPL HQ 0,2 mm
Gladstone/Halifax

★★★★★

Finishes charts see page 217 – 224.

DOOR FRAME - CROSS SECTION DRAWINGS (ILLUSTRATIVE)



PROJECT BIS door frame

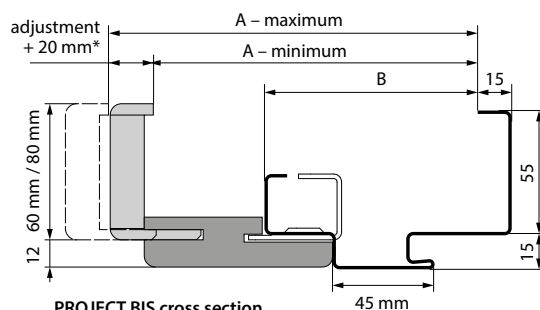

PROJECT BIS cross section

* for A range, adjustment +15 mm



PROJECT Premium door frame

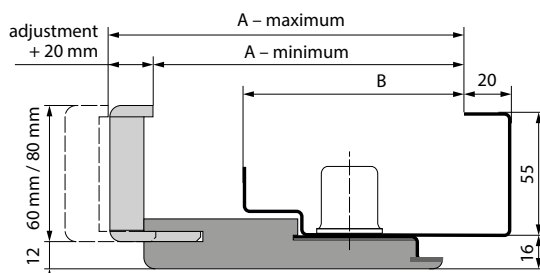

PROJECT Premium cross section

MODELS	PROJECT BIS		PROJECT PREMIUM	
	A	B	A	B
Rw=27 dB	138 ÷ 363 mm	89 mm	133 ÷ 333 mm	95 mm
Rw=32 dB	138 ÷ 363 mm	89 mm	-	-
AGATE, OPAL	138 ÷ 363 mm	89 mm	133 ÷ 333 mm	95 mm
QUARTZ	138 ÷ 363 mm	89 mm	-	-
Granite kl. C	143 ÷ 368 mm	94 mm	138 ÷ 338 mm	100 mm
EI 30	143 ÷ 368 mm	94 mm	-	-
Granite RC 3, Extreme RC 2, RC 3	147 ÷ 372 mm	98 mm	-	-
Silence 37 dB, rebated	147 ÷ 372 mm	98 mm	-	-
Silence 37 dB, non-rebated	164 ÷ 389 mm	115 mm	-	-
Rw=42 dB	162 ÷ 387 mm	113 mm	157 ÷ 357 mm	119 mm
EI 60	155 ÷ 380 mm	106 mm	-	-



P
GALVANIZED SHEET
PORTA STEEL PRODUCT



LONG LASTING DURABILITY



QUALITY GUARANTEED



MODERN DESIGN



EASY INSTALLATION



60 mm



80 mm



ADJUSTMENT



PROJECT BIS DOOR FRAME COVER

Adjustment range	AGATE, OPAL, QUARTZ, 27 dB, 32 dB	GRANITE, EI 30	Silence 37 dB rebated, Granite RC3, Extreme RC3	Silence 37 dB non-rebated	Rw = 42 dB	EI 60
A	138 ÷ 153 mm	143 ÷ 158 mm	147 ÷ 162 mm	164 ÷ 179 mm	162 ÷ 177 mm	155 ÷ 170 mm
B	158 ÷ 178 mm	163 ÷ 183 mm	167 ÷ 187 mm	184 ÷ 204 mm	182 ÷ 202 mm	175 ÷ 195 mm
C	183 ÷ 203 mm	188 ÷ 208 mm	192 ÷ 212 mm	209 ÷ 229 mm	207 ÷ 227 mm	200 ÷ 220 mm
D	203 ÷ 223 mm	208 ÷ 228 mm	212 ÷ 232 mm	229 ÷ 249 mm	227 ÷ 247 mm	220 ÷ 240 mm
E	223 ÷ 243 mm	228 ÷ 248 mm	232 ÷ 252 mm	249 ÷ 269 mm	247 ÷ 267 mm	240 ÷ 260 mm
F	243 ÷ 263 mm	248 ÷ 268 mm	252 ÷ 272 mm	269 ÷ 289 mm	267 ÷ 287 mm	260 ÷ 280 mm
G	263 ÷ 283 mm	268 ÷ 288 mm	272 ÷ 292 mm	289 ÷ 309 mm	287 ÷ 307 mm	280 ÷ 300 mm
H	283 ÷ 303 mm	288 ÷ 308 mm	292 ÷ 312 mm	309 ÷ 329 mm	307 ÷ 327 mm	300 ÷ 320 mm
I	303 ÷ 323 mm	308 ÷ 328 mm	312 ÷ 332 mm	329 ÷ 349 mm	327 ÷ 347 mm	320 ÷ 340 mm
J	323 ÷ 343 mm	328 ÷ 348 mm	332 ÷ 352 mm	349 ÷ 369 mm	347 ÷ 367 mm	340 ÷ 360 mm
K	343 ÷ 363 mm	348 ÷ 368 mm	352 ÷ 372 mm	369 ÷ 386 mm	367 ÷ 387 mm	360 ÷ 380 mm

PROJECT PREMIUM DOOR FRAME COVER

Adjustment range	AGATE, OPAL, 27dB, 32dB	GRANITE kl. C	Rw = 42 dB
B	133 ÷ 153 mm	138 ÷ 158 mm	157 ÷ 177 mm
C	153 ÷ 173 mm	158 ÷ 178 mm	177 ÷ 197 mm
D	173 ÷ 193 mm	178 ÷ 198 mm	197 ÷ 217 mm
E	193 ÷ 213 mm	198 ÷ 218 mm	217 ÷ 237 mm
F	213 ÷ 233 mm	218 ÷ 238 mm	237 ÷ 257 mm
G	233 ÷ 253 mm	238 ÷ 258 mm	257 ÷ 277 mm
H	253 ÷ 273 mm	258 ÷ 278 mm	277 ÷ 297 mm
I	273 ÷ 293 mm	278 ÷ 298 mm	297 ÷ 317 mm
J	293 ÷ 313 mm	298 ÷ 318 mm	317 ÷ 337 mm
K	313 ÷ 333 mm	318 ÷ 338 mm	337 ÷ 357 mm

K Covers in natural veneer available through Porta CONTRACT, see page 226.

TECHNICAL INFORMATION

DOOR FRAME CONSTRUCTION

Complete PROJECT BIS and PROJECT BIS PREMIUM door frames consist of:

- corner profile steel door frame, made out of galvanized steel 1,2 thick (AGATE) or 1,5 mm thick (OPAL, QUARTZ, GRANITE RC2, RC3, EXTREME RC3, GRANITE class C, Rw=27 dB, Rw=32 dB, Silence Rw=37 dB, Rw=42 dB, EI 30, EI 60), with a special profile for PROJECT covers
- specially milled elements, consisting of a head beam and two jambs and architraves made of wood-based materials
- PROJECT covers are produced and delivered as a set of elements to be assembled on site.

ACCESSORIES INCLUDED IN DOOR FRAME PRICE

- Standard accessories, depending on type of door frame and type of door leaf.

DOOR FRAME SIZE, SEE PAGE 210, TABLE 2

- '80', '90', '100'

Two options:

- To be installed on a finished floor level - '0'
- To be installed under floor level - '-30'

NOTES

- Technical Assessment ITB-KOT-2017/0245 issue 1.
- Certificate of conformity no. ITB-2617/W, ITB Warsaw
- Minimum wall thickness - 'A' range
- A project door frame requires wall opening to be enlarged $S_0 + 24$ mm (± 10) and $H_0 + 12$ (± 5) in comparison to STD sizes of steel door frames, see page 211, Table 3.

EXTRA CHARGES

- Door frame cover - CPL 0,2 mm finish - GROUP II

ACCESSORIES, DIMENSIONS & ADDITIONAL INFORMATION

At PORTA, we also offer a wide selection of door handles and accessories. These have been designed by our experts to complement your Porta Door.





Handles

Due to printing technology, the colour of presented products in the catalogue may slightly differ from the actual product.

UNICO / class 2

NEW



Handle



Lock escutcheon



Euro cylinder escutcheon



WC escutcheon

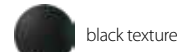

black texture



anthracite texture

ORGANIC / class 2

NEW



Handle



Lock escutcheon



Euro cylinder escutcheon



WC escutcheon

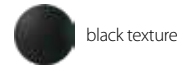

black texture



anthracite texture

ACCENT / class 2



Handle



Lock escutcheon



Euro cylinder escutcheon



WC escutcheon



silver



matt silver



matt gold

MODERN / class 2



Handle



Lock escutcheon



Euro cylinder escutcheon



WC escutcheon

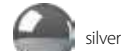

silver



matt silver



matt gold

NEXT / class 2



Handle



Lock escutcheon



Euro cylinder escutcheon



WC escutcheon



silver



matt silver



matt gold

OFFICE / class 2



Handle



Lock escutcheon



Euro cylinder escutcheon



WC escutcheon



silver



matt silver



golden



matt gold



anthracite

Handles

Due to printing technology, the colour of presented products in the catalogue may slightly differ from the actual product.

CARO / class 2



Handle



Lock escutcheon



Euro cylinder escutcheon



WC escutcheon



silver



matt silver



matt gold

ROYAL / class 2



Metal handle (72)

Lock

Euro cylinder

WC



brushed silver



old gold

TOPAZ / class 3

NEW



Handle



Lock escutcheon



Euro cylinder escutcheon



WC escutcheon



stainless steel

EUFORIA Q / class 3

NEW



Handle



Lock escutcheon



Euro cylinder escutcheon



WC escutcheon



black

CUBE / class 3

NEW



Handle



Lock escutcheon



Euro cylinder escutcheon



WC escutcheon



brushed matt nickel



brushed matt chrome

BRAVA / class 3

NEW



Handle



Lock escutcheon



Euro cylinder escutcheon



WC escutcheon



chrome



brushed chrome



black

Handles

Due to printing technology, the colour of presented products in the catalogue may slightly differ from the actual product.

ELEGANT / class 4



Handle

WE RECOMMEND! A modern thin escutcheon is a class of its own.



Lock escutcheon



Euro cylinder escutcheon



WC escutcheon



silver



black



white

SIMPLE / class 4



Handle

WE RECOMMEND! A modern thin escutcheon is a class of its own.



Lock escutcheon



Euro cylinder escutcheon



WC escutcheon



silver



black



white

ISA / class 4

NEW



Handle

WE RECOMMEND! A modern thin escutcheon is a class of its own.



Lock escutcheon



Euro cylinder escutcheon



WC escutcheon



chrome polerowany



satin chrome



black

FUSSA / class 4

NEW



Handle

WE RECOMMEND! A modern thin escutcheon is a class of its own.



Lock escutcheon



Euro cylinder escutcheon



WC escutcheon



chrome polerowany



satin chrome



black

JULIA / class 4

NEW



Handle

Handle



Lock escutcheon



Euro cylinder escutcheon



WC escutcheon



chrome

DIVO FIT / class 4

NEW



Handle

Handle

WE RECOMMEND! A modern thin escutcheon is a class of its own.



Lock escutcheon



Euro cylinder escutcheon



WC escutcheon



chrome



satin chrome



black

Handles

Due to printing technology, the colour of presented products in the catalogue may slightly differ from the actual product.

DIVO FIT / class 4

NEW

WE RECOMMEND! A modern thin escutcheon is a class of its own.



Handle



Lock escutcheon



Euro cylinder escutcheon



WC escutcheon



chrome



satin chrome



Black

FADO FIT / class 4

NEW

WE RECOMMEND! A modern thin escutcheon is a class of its own.



Handle



Lock escutcheon



Euro cylinder escutcheon



WC escutcheon



chrome



golden

HEAVY DUTY HANDLES

OVAL / class 4

NEW



Handle

Lock escutcheon

Euro cylinder escutcheon

WC escutcheon



stainless steel

KVADRAT / class 4

NEW



Handle

Lock escutcheon

Euro cylinder escutcheon

WC escutcheon



stainless steel

UNO 3S / class 3

NEW

WE RECOMMEND! A modern thin escutcheon is a class of its own.



Handle



Lock escutcheon



Euro cylinder escutcheon



WC escutcheon



stainless steel

DUE 3S / class 3

NEW

WE RECOMMEND! A modern thin escutcheon is a class of its own.



Handle



Lock escutcheon



Euro cylinder escutcheon



WC escutcheon



stainless steel

EDEL / class 3

Handle (72)

Euro cylinder

WC



stainless steel

MINI PLUS

Handle (72)

MINI PLUS



black

Handles

Due to printing technology, the colour of presented products in the catalogue may slightly differ from the actual product.

MIRO **NEW**

metal handle (72)



PORTA AGATE (I EUROPEAN CLASS)

metal handle (72)



PORTA AGATE PLUS (I EUROPEAN CLASS) **NEW**

metal handle (72)

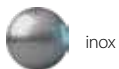

PORTA OPAL (II EUROPEAN CLASS)

metal handle (72)



PORTA OPAL PLUS (II EUROPEAN CLASS) **NEW**

metal handle (72)

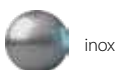

PORTA GRANITE (III EUROPEAN CLASS)

metal handle (72)



Handles

Due to printing technology, the colour of presented products in the catalogue may slightly differ from the actual product.

PORTA GRANITE PLUS (III EUROPEAN CLASS) NEW

metal handle (72)



ROYAL (III EUROPEAN CLASS) NEW

metal handle (72)



PORTA SAFE (III CLASS) NEW

metal handle (92)

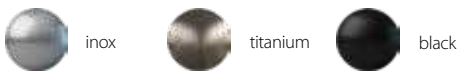

PULLS

for external doors

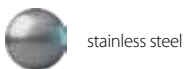

150 and 170 cm

ROUND STRAIGHT



150 cm

RECTANGULAR STRAIGHT



90 cm

CURVED ROUND



90 cm

ROUND STRAIGHT

Architraves and ventilation

ARCHITRAVES

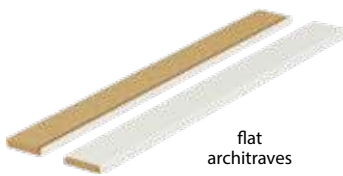

Portadecor,
Portasynchro 3D

Portaperfect 3D

Portadur, CPL HQ,
Portalamino

Premium veneer,
Gladstone/Halifax

UV acrylic paint

Natural veneer

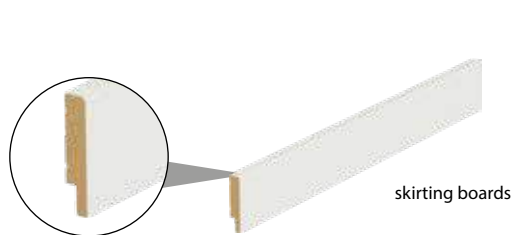

NEW

UV acrylic paint

VENTILATION SLEEVES



Ventilation sleeves
• 1 row (various colours)

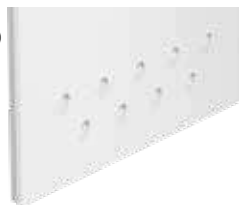

Ventilation sleeves
• 2 rows (various colours)



Ventilation undercut



Steel ventilation sleeves

- Available colours:
golden, matt gold, silver, matt silver



Ventilation grille with a mounting frame (different colours)

- This ventilation grille meets the building law regulations regarding bathroom ventilation.



Ventilation slit

STAINLESS STEEL PORTHOLE

- Porthole is available only with door leaves with hollow chipboard core for following solid models: MINIMAX, Porta DECOR, Porta CPL, ENDURO, Porta NOVA, Porta CLASSIC, Porta RESIST
- Diameter: 250 mm for door leaf size: '60', '70' and 300 mm for other sizes
- Available glass panels: transparent or laminated satin glass panel class 2, 6 mm thick



Preparation for shortening
• maximum 60 mm

ADDITIONAL ACCESSORIES

HINGES, CAPS, LOCKS



Standard barrel hinges.
Door part, frame part.
• golden, silver

PRIME barrel hinges.
Door part, frame part.
• golden, matt gold, silver, matt silver



Standard hinges caps for internal doors (a set for one hinge)
• golden, matt silver, gloss chrome, white

Villadora hinges caps (a set for one hinge)
• golden gloss, old gold, silver gloss

LOCKS



PRIME lock with gold or silver face plate.
• models finished with synthetic veneer lock latch - matt galvanized

Magnetic lock with stainless steel face plate
• for rebated and non-rebated doors

Adjustable strike plate for non-rebated doors.

We suggest choosing matt silver hinges.

ELECTRIC STRIKES

NEW



electric strike for Porta SYSTEM door frame:
• fail-secure
• fail-safe



electric strike for a Corner profile steel door frame-LARGE and for an Adjustable steel door frame:
• fail-secure
• fail-safe

NEW



3D hinges. Door part, frame part.
• golden, silver, white, black

ADDITIONAL HARDWARE



Round pull handle for sliding doors- for the price of a door leaf.
• colours: silver and gold

Hook lock, key or WC with side and front pulls. For sliding doors.
• Available in following colours: golden, matt gold, silver, matt silver

NEW



Oblong pull handles for sliding doors.
• Available in following colours: golden, matt golden, silver, matt silver, black

ENTRANCE DOOR HARDWARE



Two euro cylinders, class,B'
• silver, golden

Wide-angle door viewer
• silver, black

Stainless steel threshold, compatible with Porta door frames:
• standard (90 mm)
• widened (120 mm)



DOOR CLOSER
• available finishes: silver and brown

Technical drawings

EXAMPLES OF ASSEMBLY - MINIMAX DOOR FRAMES

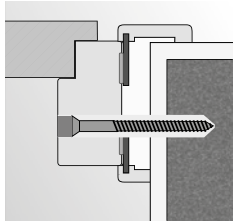

assembly with mounting foam and masonry wall anchors

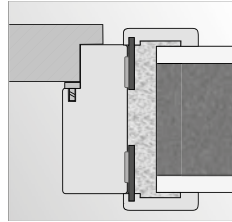

installation on a concrete wall with expanding foam

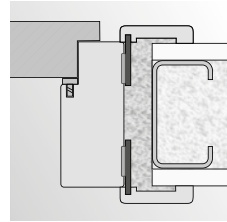

installation on a plasterboard wall with expanding foam

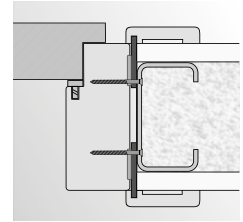

installation on a plasterboard wall with screws

OPTIONS OF INSTALLATION - CORNER PROFILE DOOR FRAMES

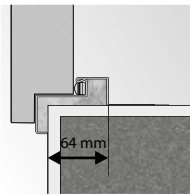

Corner profile door frame - SMALL PLUS

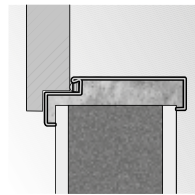

installation without anchoring elements

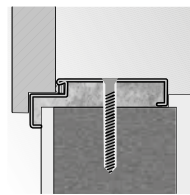

Corner profile door frame - LARGE, installation with dowel pins

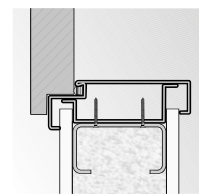

Corner profile door frame - LARGE, installation on a plasterboard wall

OPTIONS OF INSTALLATION - ADJUSTABLE DOOR FRAME, ADJUSTABLE PS WITH 'SHARP EDGES'

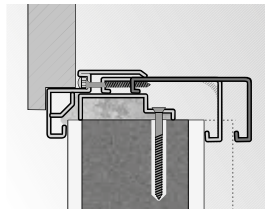

wall thickness adjustment range

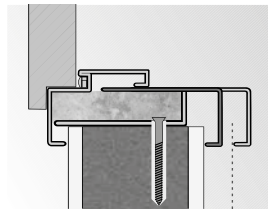

wall thickness adjustment range

EXAMPLES OF INSTALLATION - HIDE DOORS

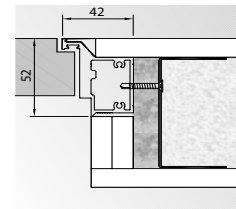

non-rebated (outward opening)

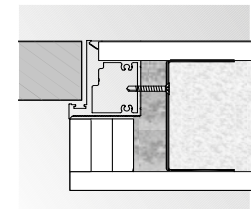

reversed rebate (inward opening)

RETRO MODULE (WITH PORTA SYSTEM DOOR FRAME)

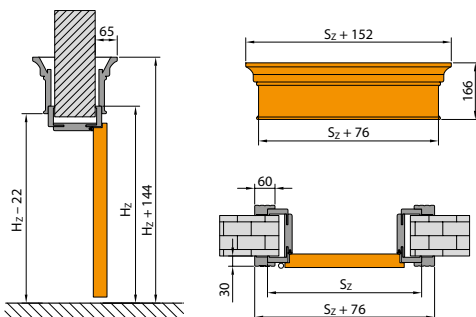

REBATED DOOR EDGE

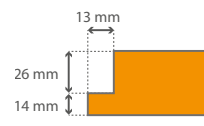

PREPARATION OF A WALL OPENING IN ORDER TO INSTALL NON-REBATED DOOR FRAME

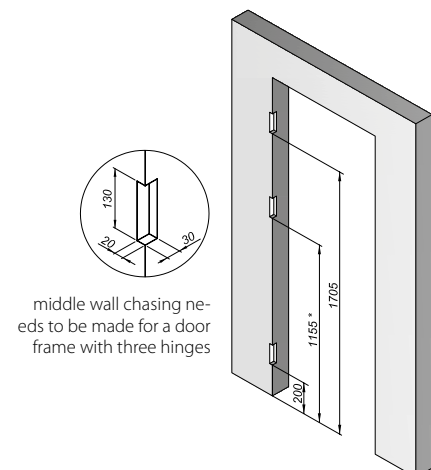

Door dimensions

■ MINIMAX DOOR FRAME ■ PORTA SYSTEM DOOR FRAME ■ PORTA SYSTEM ELEGANCE DOOR FRAME ■ LEVEL DOOR FRAME

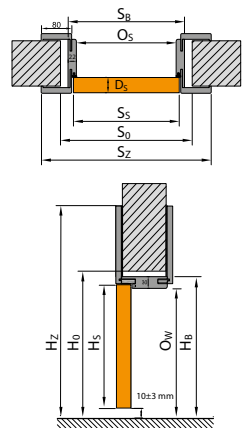
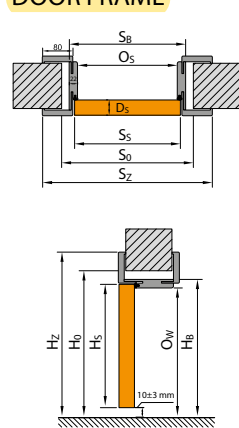
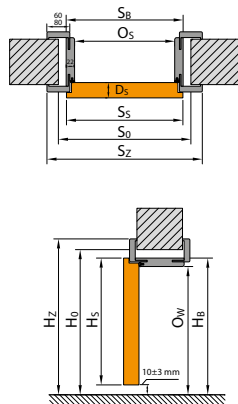
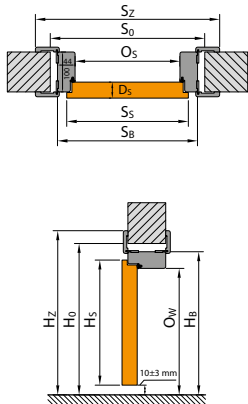

■ STEEL DOOR FRAME

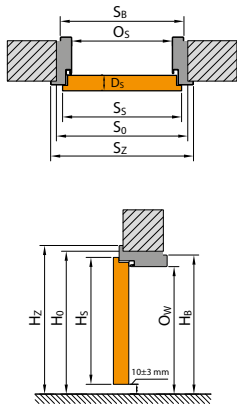

■ PORTA SLIDING SYSTEM

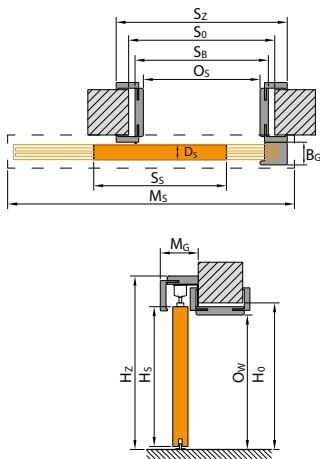

■ PORTA HIDE

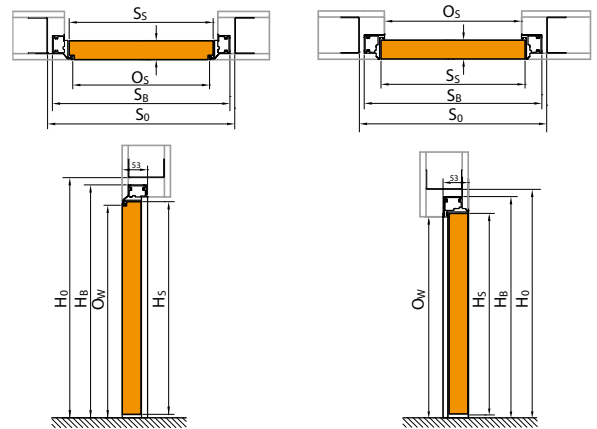

■ COMPACT SLIDING SYSTEM

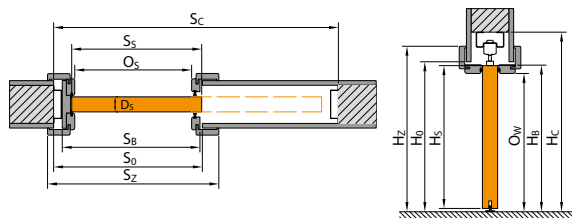

■ METAL SLIDING SYSTEM

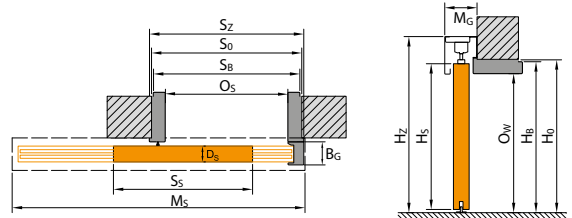

NOTE! How to calculate dimension of a double-leaf door, see p. 213

■ DIMENSIONS KEY

- S_s total door leaf width (including rebates)
- H_s total door leaf height (including rebate)
- D_s door leaf thickness
- S_o width of a wall opening prepared for installation
- H_o height of a wall opening prepared for installation, measured from finished floor level
- O_s opening width (for Alfa and Beta this dimension is decreased by the door leaf thickness)
- O_w opening height (measured from finished floor level)
- S_b door frame width without architraves
- H_b door frame height, without architraves
- S_z total door frame width with architraves
- H_z total height of door frame, including architraves
- M_s width of sliding door masking system
- M_g thickness of a rail cover (sliding systems)
- B_g thickness of a door stop (jamb) (sliding systems)
- $T_{s/w}$ acceptable width and height tolerance (wall opening)
- S_c wall opening width for a metal cassette (pocket door system)
- H_c wall opening height for a metal cassette (pocket door system), (measured from finished floor level)

Refer to architrave 60/80 mm in dimension tables (S_z).

Door dimensions tables

POLISH NORM (PN)

INTERNAL DOORS WITH WOODEN DOOR FRAMES

TABLE 1

DOOR FRAME TYPE	SIZE	S _z	H _z	D _s	S _o	H _o	O _s	O _w	S _b	H _b	S _z (6)	S _z (8)	H _z	T _{sw}
Minimax 60 mm, Minimax 100 mm, MDF in natural veneer	60	644	2030	40	710	2075	602	2016	690	2060	800	-	2115	+20/+10
	70	744			810		702		790		900	-		
	80	844			910		802		890		1000	-		
	90	944			1010		902		990		1100	-		
	100	1044			1110		1002		1090		1200	-		
Porta SYSTEM	60	644	2030	40	680	2060	602	2016	646	2038	746	786	kątownik (6) / (8) 2088 / 2108	+20/+10
	70	744			780		702		746		846	886		
	80	844			880		802		846		946	986		
	90	944			980		902		946		1046	1086		
	100	1044			1080		1002		1046		1146	1186		
	110	1144			1180		1102		1146		1246	1286		
Porta SYSTEM ELEGANCE* / LEVEL	60	618	2017	40	680	2060 / 2070	602	2016	646	2038 / 2046	-	786	2108 / panel górny (20) / (100) 2228/3028	+20/+10
	70	718			780		702		746		-	886		
	80	818			880		802		846		-	986		
	90	918			980		902		946		-	1086		
	100	1018			1080		1002		1046		-	1186		
RENOVA***	60	644	2030	40	596	2016	558	1994	584	2007	746	-	2088	+15 / -6
	70	744			696		658		684		846	-		
	80	844			796		758		784		946	-		
	90	944			896		858		884		1046	-		
	100	1044			996		958		984		1146	-		
	110	1144			1096		1058		1084		1246	-		
standard options 2.0/2.2 (architrave 80/100)	60	618	2017 / 2187	40	680	2060 / 2230	600	2016 / 2186	646	2039 / 2209	-	787 / 827	2110 / 2230** 2300 / 2400**	+20/+10
	70	718			780		700		746		-	887 / 927		
	80	818			880		800		846		-	987 / 1027		
	90	918			980		900		946		-	1087 / 1127		
	100	1018			1080		1000		1046		-	1187 / 1227		
Villadora RETRO	60	644	2030	40	680	2060	602	2016	646	2038	-	789	2110	+20/+10
	70	744			780		702		746		-	889		
	80	844			880		802		846		-	989		
	90	944			980		902		946		-	1089		
	100	1044			1080		1002		1046		-	1189		

NOTE: S_z and H_z dimensions of door frame in natural veneers are given with tolerance -1 mm / +3 mm.

*in case of choosing door leaves 220 in natural veneer, height H_s, H_o, O_w, H_b, H_z has to be enlarged - dimension with tolerance +1 mm.

**door frame option with a PLUS panel

***S_o/H_o - width/height of clear opening of old steel frame. T_{sw} - tolerance +15 mm depends on a construction of an old door frame.

INTERNAL DOORS WITH STEEL DOOR FRAMES

TABLE 2

DOOR FRAME TYPE	SIZE	S _z	H _z	D _s	S _o	H _o	O _s	O _w	S _b	H _b	S _z	H _z	T _{sw}
Corner profile door frame - SMALL PLUS	60	644	2030	40	649	2043	596	2016	629	2033	706	2071	±10/±5
	70	744			749		696		729		806		
	80*	844			849		796		829		906		
	90*	944			949		896		929		1006		
	100	1044			1049		996		1029		1106		
Corner profile door frame - LARGE for concrete walls and stainless steel LARGE folding	60	644	2030	40	675	2055	596	2016	656	2046	706	2071	±10/±5
	70	744			775		696		756		806		
	80*	844			875		796		856		906		
	90*	944			975		896		956		1006		
	100	1044			1075		996		1056		1106		
	110	1144			1175		1096		1156		1206		
Corner profile door frame - LARGE, PVC finish	60	644	2030	40	675	2055	596	2016	656	2046	706	2071	±10/±5
	70	744			775		696		756		806		
	80*	844			875		796		856		906		
	90*	944			975		896		956		1006		
	100	1044			1075		996		1056		1106		
	110	1144			1175		1096		1156		1206		
Corner profile door frame - LARGE for plaster board walls	60	644	2030	40	685	2055	596	2016	680	2046	706	2071	+10/+5
	70	744			785		696		780		806		
	80*	844			885		796		880		906		
	90*	944			985		896		980		1006		
	100	1044			1085		996		1080		1106		
	110	1144			1185		1096		1180		1206		
Adjustable steel door frame	60	644	2030	40	700	2070	596	2016	680	2058	716	2076	-10/-5
	70	744			800		696		780		816		
	80*	844			900		796		880		916		
	90*	944			1000		896		980		1016		
	100	1044			1100		996		1080		1116		
	110	1144			1200		1096		1180		1216		
Adjustable PS with sharp edges*	60	644	2030	40	700	2070	596	2016	679	2058	736	2086	-10/-5
	70	744			800		696		779		836		
	80*	844			900		796		879		936		
	90*	944			1000		896		979		1036		
	100	1044			1100		996		1079		1136		
Steel Porta SYSTEM	60	644	2030	40	675	2055	596	2016	646	2041	736	2086	±10/±5
	70	744			775		696		746		836		
	80	844			875		796		846		936		
	90	944			975		896		946		1036		
	100	1044			1075		996		1046		1136		

*NOTE! Investment norm (clear opening width 800,900 mm) is available as a standard without an extra charge - add 8 mm to S_o dimension. Please, remember to order suitable size of door leaves which are dedicated for the set.



Door dimensions tables

POLISH NORM (PN)

TECHNICAL DOORS

TABLE 3

DOOR FRAME TYPE	SIZE	S _s	H _s	D _s	S _o	H _o	O _s	O _w	S _a	H _a	S _z (6)	S _z (8)	H _z	T _{s/w}
with Porta SYSTEM door frame	60	644	2030	40	680	2060	602	2016	646	2038	746	786	kątownik (6) / (8) 2088 / 2108	+20 / +10
	70	744			780		702		746		846	886		
	80	844			880		802		846		946	986		
	90	944			980		902		946		1046	1086		
	100	1044			1080		1002		1046		1146	1186		
with reinforced Porta SYSTEM door frame	60	644	2030	44	680	2060	602	2016	650	2040	746	786	kątownik (6) / (8) 2088 / 2108	+20 / +10
	70	744			780		702		750		846	886		
	80	844			880		802		850		946	986		
	90	952			988		910		958		1054	1094		
	100	1044			1080		1002		1050		1146	1186		
Porta SILENCE Rw=37 dB adjustable rebated	80	844	2030	49 / 50	880	2060	802	2016	850	2040	946	986	2088/2108	+20 / +10
	90	968			1004		926		974		1070	1110		
	100	1044			1080		1002		1050		1146	1186		
Porta SILENCE Rw=37 dB adjustable non-rebated	80	818	2017	49 / 50	880	2060	801	2016	849	2040	-	985	-/2108	+20 / +10
	90	968			1030		951		999		-	1135		
	100	1018			1080		1001		1049		-	1185		
Porta SILENCE Rw=37 dB fixed rebated	80	844	2030	49 / 50	950	2090	802	2017	922	2077	1024	1064	2128/2148	±10 / ±5
	90	968			1074		926		1046		1148	1188		
	100	1044			1150		1002		1122		1224	1264		
Porta SILENCE Rw=37 dB fixed non-rebated	80	818	2017	49 / 50	950	2090	801	2017	921	2077	-	1063	-/2148	±10 / ±5
	90	968			1100		951		1071		-	1213		
	100	1018			1150		1001		1121		-	1263		
Porta SILENCE Rw=37dB rebated with a steel door frame	80	844	2030	49 / 50	876	2055	796	2013	856	2043	906	-	2068	±10 / ±5
	90	968			1000		920		980		1030	-		
	100	1044			1076		996		1056		1106	-		
Porta SILENCE Rw=37dB non-rebated with a steel door frame	80	818	2017	49 / 50	875	2055	795	2013	855	2043	905	-	2068	+10 / +5
	90	968			1026		945		1005		1055	-		
	100	1018			1075		995		1055		1105	-		
Rw = 42 dB with reinforced Porta SYSTEM door frame	80	868	2047	68 / 69	915	2080	802	2020	872	2056	968	1008	kątownik (6) / (8) 2104 / 2124	+20 / +10
	90	968			1015		902		972		1068	1108		
	100	1068			1115		1002		1072		1168	1208		
Rw = 42 dB with MDF door frame	80	868	2047	68 / 69	975	2105	802	2021	946	2093	1048	1088	kątownik (6) / (8) 2144 / 2164	±10 / ±5
	90	968			1075		902		1046		1148	1188		
	100	1068			1175		1002		1146		1248	1288		
Rw = 42 dB with steel door frame*	80	888	2047	68 / 69	890	2055	810	2015	870	2045	950	-	2085	±10 / ±5
	90	988			990		910		970		1050	-		
	100	1088			1090		1010		1070		1150	-		
EI 30 with MDF door frame	60	644	2030	44 / 45	750	2090	602	2014	722	2077	824	864	kątownik (6) / (8) 2128 / 2148	±10 / ±5
	70	744			850		702		822		924	964		
	80	844			950		802		922		1024	1064		
	90	952			1060		910		1030		1132	1172		
	100	1044			1150		1002		1122		1224	1264		
EI 30, Rw = 27 dB, Rw = 32 dB with a steel door frame*	60	644	2030	44 / 45 40 / 41 44 / 45	675	2055	596	2013	656	2043	706	-	2068	±10 / ±5
	70	744			775		696		756		806	-		
	80	844			875		796		856		906	-		
	90	952			985		904		964		1014	-		
	100	1044			1075		996		1056		1106	-		
Rw = 27 dB, Rw = 32 dB with a steel door frame for plaster-board walls	60	644	2030	40 / 41 44 / 45	685	2058	596	2013	680	2058	706	-	2068	+10 / +5
	70	744			785		696		780		806	-		
	80	844			885		796		880		906	-		
	90	952			993		904		988		1014	-		
	100	1044			1085		996		1080		1106	-		
EI 60 with a wooden door frame	60	668	2030	60 / 61	775	2090	626	2017	747	2077	858	-	2133	±10 / ±5
	70	768			875		726		847		958	-		
	80	868			975		826		947		1058	-		
	90	968			1075		926		1047		1158	-		
	100	1044			1085		996		1080		1106	-		
EI 60 with a steel door frame*	60	668	2030	60 / 61	700	2055	618	2011	678	2041	732	-	2068	±10 / ±5
	70	768			800		718		778		832	-		
	80	868			900		818		878		932	-		
	90	968			1000		918		978		1032	-		
	100	1044			1030		940		1011		1077	-		
Steel EI 30	60	700	2052	53	695	2065	640	2037**	673	2053	760	-	2097	±10 / ±5
	70	800			795		740		773		860	-		
	80	900			895		840		873		960	-		
	90	1000			995		940		973		1060	-		
	100	1080			1075		1020		1053		1140	-		
Steel EI 60	80	916	2054	67	930	2075	840	2029**	911	2064	977	-	2097	±10 / ±5
	90	1016			1030		940		1011		1077	-		
	100	1116			1130		1040		1111		1177	-		
ENDURO	60	644	2030	40	675	2055	596	2016	656	2046	706	-	2071	±10 / ±5
	70	744			775		696		756		806	-		
	80	844			875		796		856		906	-		
	90	952			985		904		964		1014	-		
	100	1044			1075		996		1056		1106	-		
ENDURO with a swinging door frame	60	618	2017	40	750	2085	638	2030	728	2075	728	-	2075	±10 / ±5
	70	718			850		738		828		828	-		
	80	818			950		838		928		928	-		
	90	918			1050		938		1028		1028	-		
	100	1018			1150		1038		1128		1128	-		
AQUA	60	618	2017	40	675	2055	596	2016	656	2046	706	-	2071	±10 / ±5
	70	718			775		696		756		806	-		
	80	818			875		796		856		906	-		
	90	926			983		904		964		1014	-		
	100	1018			1075		996		1056		1106	-		
Multipurpose doors for utility rooms	70	715	2017	40***	760	2050	700	2018	739	2038	796	-	2066	±10 / ±5
	80	815			860		800		839		896	-		
	90	915			960		900		939		996	-		
Steel BASIC and Steel BASIC PLUS with a corner profile door frame - SMALL PLUS	80	852	2030	40	857	2043 - Basic 2047 - Basic PLUS	804	2016	837	2033	914	-	2071 - Basic 2075 - Basic PLUS	±10 / ±5
	90	952			957		904		937		1014	-		
	100	1052			1057		1004		1037		1114	-		

** Project (BIS and Premium) requires enlarging the wall opening So by 24 mm and Ho by 12 mm (dimension tolerance +10 mm/ +5 mm)

Other Project door frame sizes, see drawing on page 196.

** Steel threshold decreases given dimension by 16 mm.

*** Door leaf thickness is measured on vertical edges (door leaf without infill, opened from closing side).



Door dimensions tables

POLISH NORM (PN)

APARTMENT ENTRANCE DOORS

TABLE 4

DOOR FRAME TYPE	SIZE	S _s	H _s	D _s	S _o	H _o	O _s	O _w	S _b	H _b	S _z (6)	S _z (8)	H _z	T _{sw}
AGATE, OPAL, QUARTZ, GRANITE kl. C with a steel door frame**	80	844	2030*	40 / 41 44 / 45 48 / 49	876	2056	796	2016**	856	2046	906	-	2071	±10 / ±5
	90	952			904		964		1014		-			
	100	1044			996		1056		1106		-			
AGATE, OPAL with a MDF 100 mm door frame	80	844	2030	40	910	2075	802	2016	890	2060	1000	-	2115	+20 / +10
	90	952			910		998		1108		-			
	100	1044			1002		1090		1200		-			
EXTREME RC2, GRANITE RC 3, EXTREME RC 3 with a steel door frame**	80	844	2032	50	876	2056	796	2016	856	2046	906	-	2071	+10 / +5
	90	968			920		980		1030		-			
	100	1044			996		1056		1106		-			
GRANITE RC 3, EXTREME RC 3 with PS frame	80	844	2032	50	880	2060	802	2018	850	2042	-	986	2110	+20 / +10
	90	968			926		974		-		1110			
	100	1044			1002		1050		-		1186			
Steel SAFE	80	868	2037	54	900	2065	820	2023***	880	2053	930	-	2078	±10 / ±5
	90	968			920		980		1030		-			
	100	1068			1020		1080		1130		-			

* for Granite class C Hs=2032

** Project (BIS and Premium) requires enlarging the wall opening So by 24 mm and Ho by 12 mm (dimension tolerance +10 mm / +5 mm)

Other Project door frame sizes, see drawing on page 196.

*** Steel threshold decreases given dimension by 16 mm.

EXTERNAL DOORS

TABLE 5

	SIZE	S _s	H _s	D _s	S _o	H _o	O _s	O _w	S _b	H _b	S _z	H _z	T _{sw}
Steel SAFE	80	868	2037	54	900	2065	820	2023*	880	2053	930	2078	±10 / ±5
	90	968			1000		920		980		1030		
	100	1068			1100		1020		1080		1130		
Steel SAFE with Thermo door frame	80	868	2037	54	900	2065	822	2023*	882	2053	932	2078	±10 / ±5
	90	968			1000		922		982		1032		
	100	1068			1100		1022		1082		1132		
Steel ENERGY PROTECT	80	868	2037	66	900	2065	822	2023*	882	2053	932	2078	±10 / ±5
	90	968			1000		922		982		1032		
	100	1068			1100		1022		1082		1132		
Eco POLAR PASSIVE / Eco POLAR	90	952	2067	79/68	1090	2135	920	2010	1060	2116	-	-	±10 / ±5
Eco POLAR PASSIVE / Eco POLAR + a transom	90+30	1052			1390		1360						
Eco POLAR PASSIVE / Eco POLAR + two transoms	30+90+30	967			1690		1660						
Eco POLAR PASSIVE / Eco POLAR + a transom	90+40	967	1490	1460	2116	-	-	±10 / ±5					
Eco POLAR PASSIVE / Eco POLAR + two transoms	40+90+40	967	1890	1860	2116	-	-	±10 / ±5					
Eco POLAR PASSIVE / Eco POLAR + a transom	90+50	967	1590	1560	2116	-	-	±10 / ±5					
Eco POLAR PASSIVE / Eco POLAR + two transoms	50+90+50	967	2090	2060	2116	-	-	±10 / ±5					
Eco POLAR PASSIVE / Eco POLAR	100	1067	2067	79/68	1190	2135	1020	2010	1160	2116	-	-	±10 / ±5
Eco POLAR PASSIVE / Eco POLAR + a transom	100+30	1067			1490		1460						
Eco POLAR PASSIVE / Eco POLAR + two transoms	30+100+30	1067			1790		1760						
Eco POLAR PASSIVE / Eco POLAR + a transom	100+40	1067	1590	1560	2116	-	-	±10 / ±5					
Eco POLAR PASSIVE / Eco POLAR + two transoms	40+100+40	1067	1990	1960	2116	-	-	±10 / ±5					
Eco POLAR PASSIVE / Eco POLAR + a transom	100+50	1067	1690	1660	2116	-	-	±10 / ±5					
Eco POLAR PASSIVE / Eco POLAR + two transoms	50+100+50	1067	2190	2160	2116	-	-	±10 / ±5					

* Steel threshold decreases given dimension by 16 mm.

PORTA HIDE DOORS

TABLE 6

	SIZE	S _s	S _b	S _o	O _s	H _s	H _b	O _w	H _o				
PN non-re- bated (opening outward)	60	618	687	700	603	2027	2069	2027	2080				
	70	718	787	800	703								
	80	818	887	900	803								
	90	918	987	1000	903								
	100	1018	1087	1100	1003								
CN non-re- bated (opening outward)	60	622	691	710	607	1982	2024	1982	2030				
	70	722	791	810	707								
	80	822	891	910	807								
	90	922	991	1010	907								
	100	1022	1091	1110	1007								
DIN non-re- bated (opening outward)	60	584	653	670	519	1982	2024	1982	2030				
	70	709	778	795	694								
	80	834	903	920	819								
	90	959	1028	1045	944								
	100	1022	1091	1110	1007								
HN non-re- bated (opening outward)	70	689	758	770	674	2072	2114	2072	2120				
	80	839	908	920	824								
	90	939	1008	1020	924								
	60	618	687	700	603					2017	2059	2017	2070
	70	718	787	800	703								
80	818	887	900	803									
90	918	987	1000	903									
100	1018	1087	1100	1003									
CN with a re- versed rebate (opening inward)	60	622	691	710	607	1972	2014	1972	2020				
	70	722	791	810	707								
	80	822	891	910	807								
	90	922	991	1010	907								
	100	1022	1091	1110	1007								
DIN with a re- versed rebate (opening inward)	60	584	653	670	519	1972	2014	1972	2020				
	70	709	778	795	694								
	80	834	903	920	819								
	90	959	1028	1045	944								
	100	1022	1091	1110	1007								
HN with a re- versed rebate (opening inward)	70	689	758	770	674	2062	2104	2062	2110				
	80	839	908	920	824								
	90	939	1008	1020	924								



Door dimensions tables

POLISH NORM (PN)

SLIDING SYSTEMS, FOLDING DOORS

TABLE 7

	SIZE	S _s	H _s	D _s	S _o	H _o	O _s	O _w	S _b	H _b	S _z	H _z	M _s	M _g	B _g	T _{sw}
,METAL' sliding system for concrete walls	60	644	2030	40	670	2055	600	2018	660	2048	680	2114	1310	82	58	+10 / +5
	70	744			770		700		760		780		1510			
	80	844			870		800		860		880		1710			
	90	944			970		900		960		980		1910			
	100	1044			1070		1000		1060		1080		2110			
,METAL' sliding system for plasterboard walls	60	644	2030	40	685	2055	600	2018	660	2048	680	2114	1310	82	58	+10 / +5
	70	744			785		700		760		780		1510			
	80	844			885		800		860		880		1710			
	90	944			985		900		960		980		1910			
	100	1044			1085		1000		1060		1080		2110			

	SIZE	S _s	H _s	D _s	S _o	H _o	O _s	O _w	H _z	M _s (6)/(8)	M _g	B _g	T _{sw}
Porta sliding system	60	644	2030	40	680	2060	602	2016	2119	1413	103	60	+20 / +10
	70	744			780		702			1613			
	80	844			880		802			1813			
	90	944			980		902			2013			
	100	1044			1080		1002			2213			

	SIZE	S _s	H _s	D _s	S _o (6)/(8)	H _o	O _s (6)	O _s (8)	O _w	H _z	M _s (6)/(8)	M _g	T _{sw}
ALU sliding system	60	744	2030	40	680/640	2060	602	560	2016	2114	1435	63	+20 / +10
	70	844			780/740		702	660			1653		
	80	944			880/840		802	760			1853		
	90	1044			980/940		902	860			2053		
	130	2 x 744			1420/1380		1345	1304			2857		
	150	2 x 844			1620/1580		1545	1504			3257		
	170	2 x 944			1820/1780		1745	1704			3657		

	SIZE	S _s	H _s	D _s	S _o (6)/(8)	H _o	O _s	O _w	S _b	H _b	S _z (6)	S _z (8)	H _z (6)/(8)	T _{sw}
ALFA system	60	644	2000	40	680	2060	460	2016	646	2043	746	786	2088/2108	+20 / +10
	70	744			780		560		746		846	886		
	80	844			880		660		846		946	986		
	90	944			980		760		946		1046	1086		
	100	1044			1080		860		1046		1146	1186		
BETA system	60	588	1990	40	680	2070	450	2016	646	2050	746	786	2088/2108	+20 / +10
	70	688			780		550		746		846	886		
	80	788			880		650		846		946	986		
	90	888			980		750		946		1046	1086		

	SIZE	S _s	H _s	D _s	S _o *	H _o *	O _s	O _w	S _b	H _b	S _z (6)	S _z (8)	H _z (6)/(8)	S _c	H _c	T _{sw}
COMPACT pocket door system - single	60	644	2030	40	660	2065	600	2018	654	2040	744	784	2090 / 2110	1355	2130	+10 +5
	70	744			760		700		754		844	884		1555		
	80	844			860		800		854		944	984		1755		
	90	944			960		900		954		1044	1084		1955		
	100	1044			1060		1000		1054		1144	1184		2155		
COMPACT pocket door system - double	2 x 60	644	2030	40	1265	2065	1214	2018	1258	2040	1358	1398	2090 / 2110	2610	2130	+10 +5
	2 x 70	744			1465		1414		1458		1558	1598		3010		
	2 x 80	844			1665		1614		1658		1758	1798		3410		
	2 x 90	944			1865		1814		1858		1958	1998		3810		
	2 x 100	1044			2065		2014		2058		2158	2198		4210		

* For COMPACT pocket door system, H_o and S_o sizes refer to opening dimension of steel cassette to be installed with wood-based door frame.

DOOR FRAME TYPE	SIZE	S _s	H _s	D _s	S _o	H _o	M _s	T _{sw}
BLACK sliding system	70	744	2090	40	2060	2000	±10 / ±5	
	80	844						
	90	944						
	100	1044						
SLIDE sliding system	70	744	2200	40	2060	2010	±10 / ±5	
	80	844						
	90	944						
	100	1044						

NOTES:

- Dimensions tolerance according to PN: to 1 m ±1mm, above 1 m ±2mm.
- Side door panels for rebated door sets are available in natural veneer in size '40', S_s=444, H_s=2030.
- Door frames are designed to be installed on finished floor level. For steel door frames there is a possibility to order them in lengthen option + 30 mm (to be mounted under floor level). In this case sizes H_s and H_z are enlarged by 30 mm (level -30).
- Given dimension refers to internal door leaves, both rebated and sliding
- Porta SYSTEM integrated with an upper transom. Dimensions H_o, H_b, H_z +302 mm.
- Project (BIS and Premium) requires enlarging the wall opening S_o by 24 mm and H_o by 12 mm (dimension tolerance ±10 mm / ±5 mm)

Door dimensions tables

CZECH NORM/GERMAN NORM (CN/DIN)

INTERNAL DOORS

TABLE 8

TYPE OF DOOR FRAME CN / DIN	SIZE	S ₃	H _z	D ₃	S ₀	H ₀	O ₃	O _w	S _B	H _B	S ₂ (6)	S ₂ (8)	H _z (6) / (8)	T _{sw}
Minimax 60 mm Minimax 100 mm MDF in natural veneer	60	648/610	1985	40	715/680	2030	606/569	1971	694/657	2015	804/767	-	2070	+20 / +10
	70	748/735			815/805		706/694		794/782		904/892	-		
	80	848/860			915/930		806/819		894/907		1004/1017	-		
	90	948/985			1015/1055		906/944		994/1032		1104/1142	-		
	100	1048/-			1115/-		1006/-		1094/-		1204/-	-		
Porta SYSTEM door frame	60	648/610	1985	40	685/650	2015	606/569	1971	650/613	1993	750/713	790/753	architrave (6) / (8) 2043/2063	+20 / +10
	70	748/735			785/775		706/694		750/738		850/838	890/878		
	80	848/860			885/900		806/819		850/863		950/963	990/1003		
	90	948/985			985/1025		906/944		950/988		1050/1088	1090/1128		
	100	1048/-			1085/-		1006/-		1050/-		1150/-	1190/-		
Porta SYSTEM ELEGANCE / LEVEL door frames	60	622/584	1972	40	685/650	2015	606/569	1971	650/613	1993	-	790/753	2063	+20 / +10
	70	722/709			785/775		706/694		750/738		-	890/878		
	80	822/834			885/900		806/819		850/863		-	990/1003		
	90	922/959			985/1025		906/944		950/988		-	1090/1128		
	100	1022/-			1085/-		1006/-		1050/-		-	1190/-		
RENOVA** door frame	60	648/610	1985	40	600/561	1968	562/525	1949	588/551	1962	750/713	-	2043	+15* -6
	70	748/735			700/686		662/650		688/676		850/838	-		
	80	848/860			800/811		762/775		788/801		950/963	-		
	90	948/985			900/936		862/900		888/926		1050/1088	-		
	100	1048/-			1000/-		962/-		988/-		1150/-	-		
	110	-/-			-/-		-/-		-/-		-/-	-		
Corner profile door frame - SMALL PLUS	60	648/610	1985	40	654/615	1995	600/561	1968	633/594	1985	690/651	-	2013	±10 / ±5
	70	748/735			754/740		700/686		733/719		790/776	-		
	80	848/860			854/865		800/811		833/844		890/901	-		
	90	948/985			954/990		900/936		933/969		990/1026	-		
	100	1048/-			1054/-		1000/-		1033/-		1090/-	-		
Corner profile door frame - LARGE for concrete walls and stainless steel LARGE folding	60	648/610	1985	40	680/640	2010	600/561	1968	660/621	1998	690/651	-	2013	±10 / ±5
	70	748/735			780/765		700/686		760/746		790/776	-		
	80	848/860			880/890		800/811		860/871		890/901	-		
	90	948/985			980/1015		900/936		960/996		990/1026	-		
	100	1048/-			1080/-		1000/-		1060/-		1090/-	-		
Corner profile door frame - LARGE, PVC finish	60	648/610	1985	40	680/640	2010	600/561	1968	660/621	1998	710/671	-	2023	±10 / ±5
	70	748/735			780/765		700/686		760/746		810/796	-		
	80	848/860			880/890		800/811		860/871		910/921	-		
	90	948/985			980/1015		900/936		960/996		1010/1046	-		
	100	1048/-			1080/-		1000/-		1060/-		1110/-	-		
Corner profile door frame - LARGE, for plasterboard walls	60	648/610	1985	40	685/645	2010	600/561	1968	660/621	1998	690/651	-	2013	+10 / +5
	70	748/735			785/770		700/686		760/746		790/776	-		
	80	848/860			885/895		800/811		860/871		890/901	-		
	90	948/985			985/1020		900/936		960/996		990/1026	-		
	100	1048/-			1085/-		1000/-		1060/-		1090/-	-		
ADJUSTABLE door frame	60	648/610	1985	40	705/665	2020	600/561	1968	684/645	2010	720/681	-	2028	-10 / -5
	70	748/735			805/790		700/686		784/770		820/806	-		
	80	848/860			905/915		800/811		884/895		920/931	-		
	90	948/985			1005/1040		900/936		984/1020		1020/1056	-		
	100	1048/-			1105/-		1000/-		1084/-		1120/-	-		
ADJUSTABLE PS 'with sharp edges' door frame	60	648/610	1985	40	705/665	2020	600/561	1968	683/644	2010	740/701	-	2038	-10 / -5
	70	748/735			805/790		700/686		783/769		840/826	-		
	80	848/860			905/915		800/811		883/894		940/951	-		
	90	948/985			1005/1040		900/936		983/1019		1040/1076	-		
	100	1048/-			1105/-		1000/-		1083/-		1140/-	-		
Embrancing steel door frame	60	648/610	'1985 / 2115****	40	670/635	'2005 / 2135****	600/561	'1970 / 2100****	660/621	'2000 / 2130'	720/681	-	'2030 / 2160****	±10/±5
	70	748/735			770/760		700/686		760/746		820/806	-		
	80	848/860			870/885		800/811		860/871		920/931	-		
	90	948/985			970/1010		900/936		960/996		1020/1056	-		
	100	1048/1110			1070/1135		1000/1061		1060/1121		1120/1181	-		
	110	1148/-			1170/-		1100/-		1160/-		1220/-	-		

APARTMENT ENTRANCE DOORS

TABLE 9

CN / DIN	SIZE	S ₃	H _z	D ₃	S ₀	H ₀	O ₃	O _w	S _B	H _B	S ₂	S ₂ (8)	H _z	T _{sw}
AGATE, OPAL, QUARTZ, GRANITE *	80	848/860	1985	40/44	880/890	2010	800/811	1968**	860/871	1998	910/921	-	2023	±10 / ±5
	90	948/985		44/48	980/1015		900/936		960/996		1010/1046	-		
	100	1048/-		45/47	1080/-		1000/-		1060/-		1110/-	-		

SLIDING DOOR SYSTEMS, FOLDING DOORS

TABLE 10

CN / DIN	SIZE	S ₃	H _z	D ₃	S ₀	H ₀	O ₃	O _w	S _B	H _B	S ₂ (6)	S ₂ (8)	H _z (6), (8)	T _{sw}
System ALFA	60	648/610	1952	40	685/650	2015	465/425	1971	650/613	1993	750/713	790/753	architrave (6) / (8) 2043/2063	+20 / +10
	70	748/735			785/775		565/550		750/738		850/838	890/878		
	80	848/860			885/900		665/675		850/863		950/963	990/1003		
	90	948/985			985/1025		765/800		950/988		1050/1088	1090/1128		
	100	1048/-			1085/-		865/-		1050/-		1150/-	1190/-		
System BETA	60	592/554	1945	40	685/650	2015	455/415	1971	650/613	2043	750/713	790/753	architrave (6) / (8) 2043/2063	+20 / +10
	70	692/680			785/775		555/540		750/738		850/838	890/878		
	80	792/806			885/900		655/665		850/863		950/963	990/1003		
	90	892/930			985/1025		755/790		950/988		1050/1088	1090/1128		



Door dimensions tables

CZECH NORM/GERMAN NORM (CN/DIN)

SLIDING DOOR SYSTEMS

TABLE 11

CN / DIN	SIZE	S _s	H _s	D _s	S _o	H _o	O _s	O _w	H _z	M _z (6), (8)	M _c	B _c	T _{sw}
Porta sliding door system	60	644	1985	40	680	2015	602	1971	2074	1413	103	60	+20 / +10
	70	744			780		702			1613			
	80	844			880		802			1813			
	90	944			980		902			2013			
	100	1044			1080		1002			2213			

CN	SIZE	S _s	H _s	D _s	S _o	H _o	O _s	O _w	S _b	H _b	S _z (6)	S _z (8)	H _z (6),(8)	S _c	H _z (80)	T _{sw}
COMPACT sliding door system – single	60	644	1985	40	660	2020	600	1973	654	1995	744	784	'2045 / 2065'	1355	2083	+10 / +5
	70	744			760		700		754		844	884		1555		
	80	844			860		800		854		944	984		1755		
	90	644			960		900		954		1044	1084		1955		
	100	1044			1060		1000		1054		1144	1184		2155		
COMPACT sliding door system – double	2x60	644	1985	40	1300	2020	1249	1973	1293	1995	1393	1433	'2045 / 2065'	+10/+5	2083	+10 / +5
	2x70	744			1500		1449		1493		1593	1633		3045		
	2x80	844			1700		1649		1693		1793	1833		3445		
	2x90	644			1900		1849		1893		1993	2033		3845		
	2x100	1044			2100		2049		2093		2193	2233		4245		

TRANSOMS

TABLE 12

CN	H./W.	S _o /H _o	O _s /O _w	S _b /H _b	S _z /H _z (6)	S _z /H _z (8)	T _{sw}
single Porta SYSTEM transoms	40	485	406	450	550	590	+20 / +20
	50	585	506	550	650	690	
	60	685	606	650	750	790	
	70	785	706	750	850	890	
	80	885	806	850	950	990	
	90	985	906	950	1050	1090	
	100	1085	1006	1050	1150	1190	
	00*60'	-/1977	-/1899	-/1943	-/2043	-	
00*80'	-/1957	-/1879	-/1923	-	-/2063		
double Porta SYSTEM transoms	60+30	1030	945	989	1089	1129	+20 / +20
	60+40	1130	1045	1089	1189	1229	
	60+50	1230	1145	1189	1289	1329	
	60+60	1330	1245	1289	1389	1429	
	70+60	1430	1345	1389	1489	1529	
	70+70	1530	1445	1489	1589	1629	
	80+70	1630	1545	1589	1689	1729	
	80+80	1730	1645	1689	1789	1829	
	90+80	1830	1745	1789	1889	1929	
	90+90	1930	1845	1889	1989	2029	
	100+90	2030	1945	1989	2089	2129	
	100+100	2130	2045	2089	2189	2229	

CN	H./W.	S _o /H _o	O _s /O _w	S _b /H _b	S _z /H _z (6)	S _z /H _z (8)	T _{sw}
single Porta SYSTEM transoms	50	525	444	488	588	628	+20 / +20
	60	650	569	613	713	753	
	70	775	694	738	838	878	
	80	900	819	863	963	1003	
	90	1025	944	988	1088	1108	
	00*60'	-/1977	-/1899	-/1943	-/2043	-	
	00*80'	-/1957	-/1879	-/1923	-	-/2063	

* Project (BIS and Premium) requires enlarging the wall opening S_o by 24 mm and H_o by 12 mm (dimension tolerance +10 mm/ +5 mm)

Other Project door frame sizes, see drawing on page 196.

*** Steel threshold decreases given dimension by 16 mm.

Durability levels of Porta finishes

■ CHECK THE NUMBER OF STARS NEXT TO EVERY FINISH

You can find six groups in below classification of Porta finishes. Finishes were grouped considering quality, durability and resistance to external conditions. We hope that this classification will help you to make the best possible choice. You can find the information about durability level next to each product.

<p>ECONOMIC ★☆☆☆☆</p> <p>The most advantageous combination of cost, and quality.</p>	<p>STANDARD ★★☆☆☆</p> <p>Basic durability level which provides the possibility of long-term use in household.</p>	<p>STANDARD PLUS ★★★☆☆</p> <p>Improved STANDARD class with enhanced parameters of resistance to abrasion and humidity.</p>
<p>PREMIUM ★★★★★</p> <p>A perfect combination of design and guaranteed high quality. Indications for use: residential buildings and offices.</p>	<p>PROFESSIONAL ★★★★★</p> <p>Durability level that combines great practicality and elegance in any place where doors are directly exposed to long-term external factors. Suggested indications for use: hotels, public buildings and offices.</p>	<p>EXTREME ★★★★★</p> <p>High durability level which guarantees door protection from intensive usage. Indications for use - places with heavy foot traffic, where hundreds of people pass daily.</p>

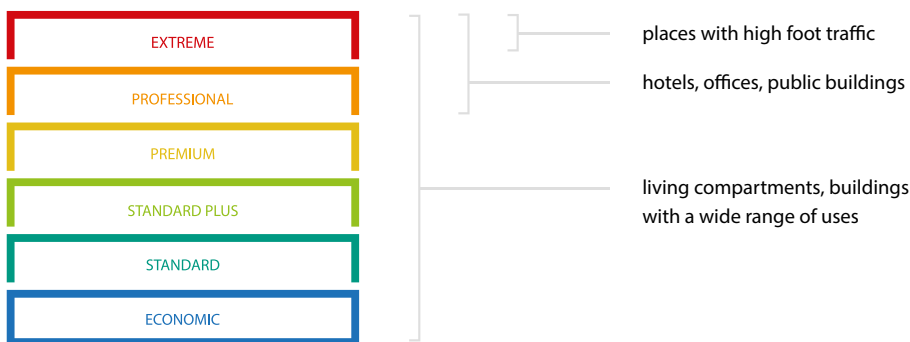

Detailed veneer data, see webpage: www.porta.com.pl/kartyoklein



Especially for you, basing on European standards, we have developed a classification of finishes (durability levels). We took into account various external factors which directly affects the durability of the door surface. Durability levels depends on the resistance to the following factors which make an impact on doors and finishes in everyday use.

ABRASION



Unavoidable during any door usage. Every day doors are exposed to lots of abrasions, caused by people walking through and opening doors inappropriately because of their hands occupied with documents or belongings.

DAYLIGHT



The factor which changes the colour shade in long term use. We have checked all types of veneer for you. Especially their reaction to daylight during long year use. We are proud to emphasize that the finishes we chose, achieve very good results throughout the entire time of use.

DETERGENTS



Housekeeping, both at home and in a workplace involves the use of detergents which make an impact on surface durability.

HUMIDITY



Direct exposure to highly humid air influences veneer. Its resistance to this factor guarantees constancy of shape and solid surface throughout the whole time of use.

Finishes charts

RAL colours



Standard paint ★★☆☆☆☆



Premium paint ★★☆☆☆☆



WHITE COLOUR IS COMPARABLE WITH RAL 9003

UV acrylic paint ★★☆☆☆☆



Premium veneer ★★☆☆☆☆



Due to technology and use of various materials for door frames and door leaves, there might appear slight difference between them.

SUPER MATT veneer ★★☆☆☆☆

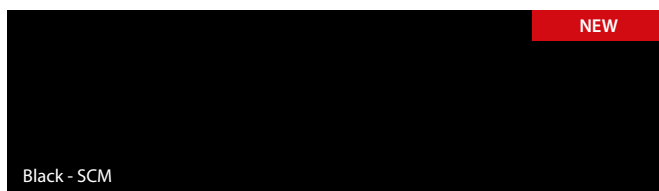

Portaperfect 3D veneer ★★☆☆☆☆

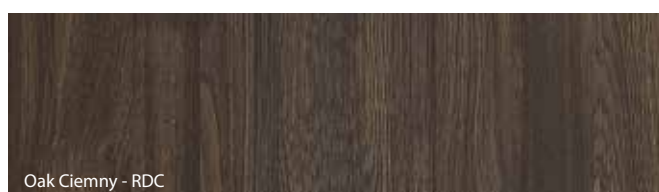
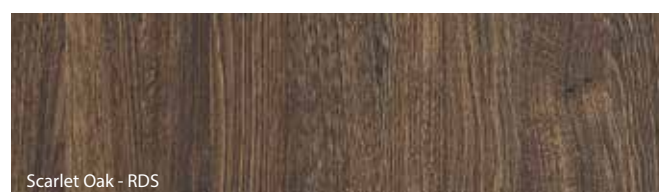
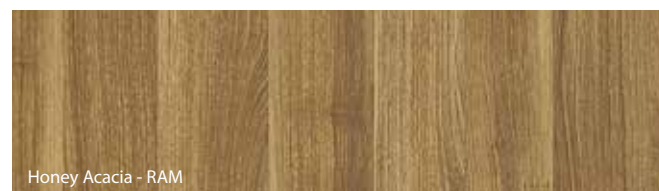

At Porta we do our best to create a perfect colour match of offered doorsets. However due to technology and materials slight differences may appear.

Finishes charts

Portadecor veneer ★★☆☆☆☆

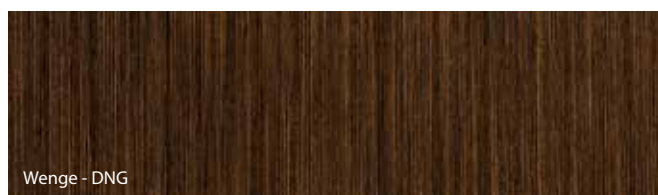
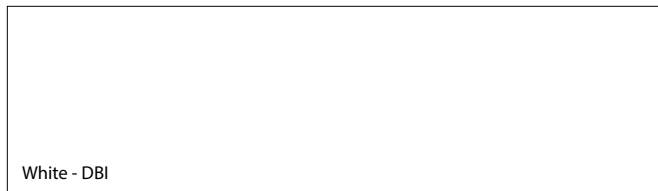

* until stocks last

Portadur veneer ★★☆☆☆☆



At Porta we do our best to create a perfect colour match of offered doorsets. However due to technology and materials slight differences may appear.

Finishes charts

Portalamino veneer ★★★★★☆



Portaperfect 3D veneer ★★★★★☆

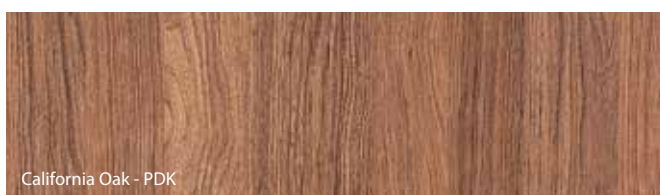

Gladstone/Halifax board ★★★★★★

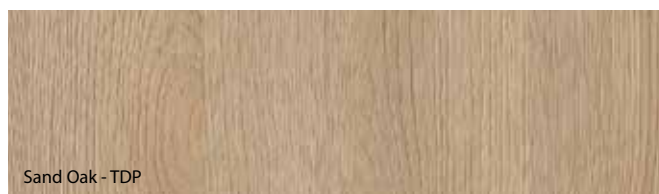

At Porta we do our best to create a perfect colour match of offered doorsets. However due to technology and materials slight differences may appear.

Finishes charts

Water-based exterior varnish ★★★★★☆



natural veneer/burl



ANHRACITE IS COMPARABLE WITH RAL 7024

CPL HQ 0,2 veneer ★★★★★☆

HPL, CPL 0,7 veneer ★★★★★★

NEW

White - 2BM

White - HBM / 7BM

Grey Euroinvest - 2PO

Grey Euroinvest - HPO / 7PO

Oak Milano 1 - 2D1

Oak Milano 1 - 7D1

Whitened Walnut - 2OB

Whitened Walnut - HOB / 7OB

Porta Beech - 2UU

Porta Beech - 7UU

Natural Oak - 2DA

Natural Oak - HDA / 7DA

Oak Milano 2 - 2D2

Oak Milano 2 - 7D2

Oak Milano 4 - 2D4

Oak Milano 4 - 7D4

WHITE COLOUR IS COMPARABLE WITH RAL 9003

Group I

At Porta we do our best to create a perfect colour match of offered doorsets. However due to technology and materials slight differences may appear.



Finishes charts

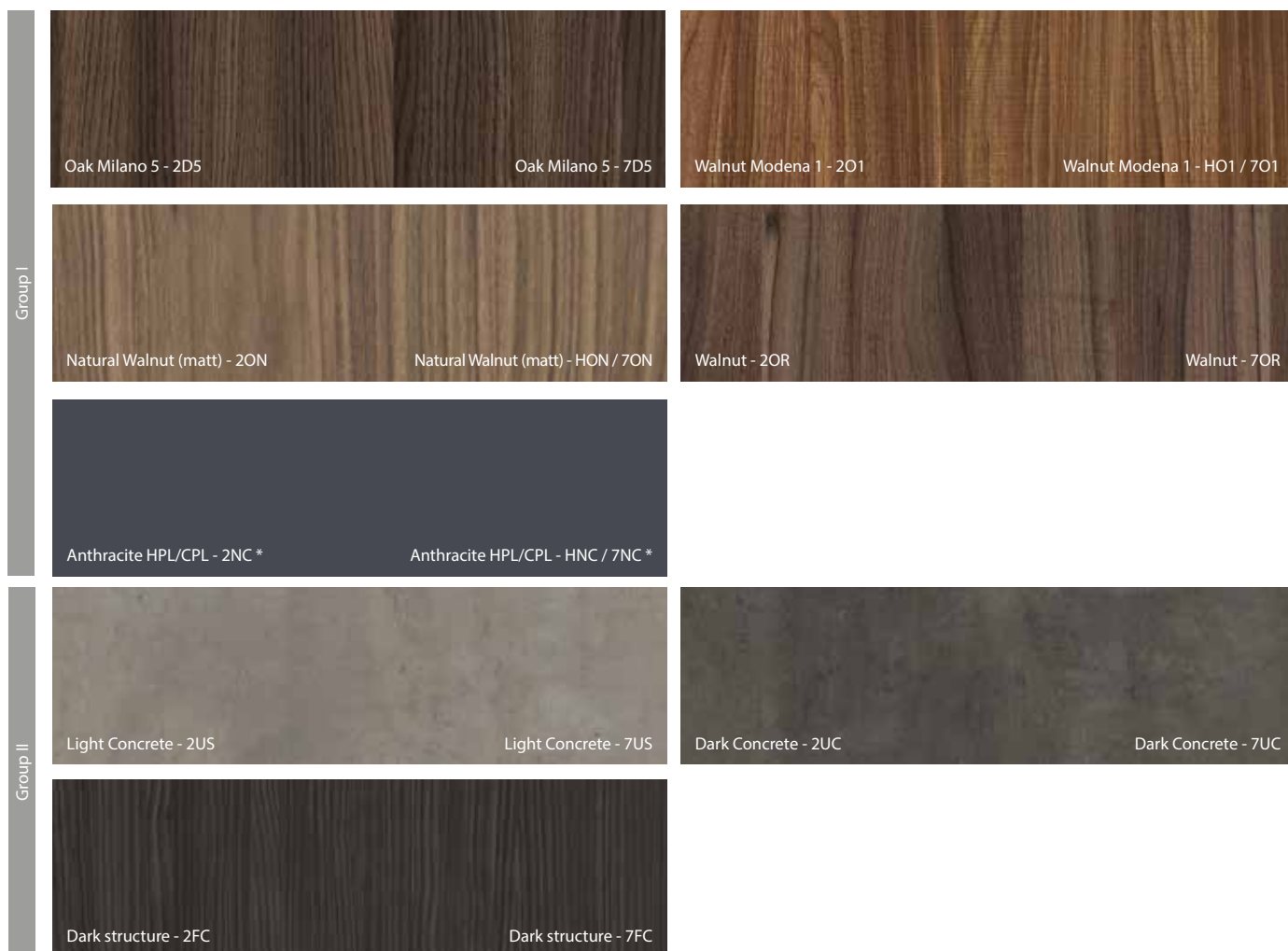

Characteristic of HPL and CPL veneers: www.porta.com.pl/dm/charakterystykaHPLCPL.pdf

* HPL/CPL marking is introduced because of dedicated powder paint Anthracite HPL/CPL

Natural veneer - Select ★★★★★☆☆



natural veneer/burl



Natural veneer - Oak ★★★★★☆☆



At Porta we do our best to create a perfect colour match of offered doorsets. However due to technology and materials slight differences may appear.



Finishes charts



natural veneer/burl

Natural veneer - Ash ★★★★★☆☆



Ash - KJ1

Natural veneer - Walnut ★★★★★☆☆



Walnut - KO1

Natural veneer - Oak Satin ★★★★★☆☆



White Oak - NBI / KBI



Light Oak - NDJ/KDJ



Oak Winchester - NDE/KDE



Tabacco - NTC / KTC



Brown Oak - NDR/KDR

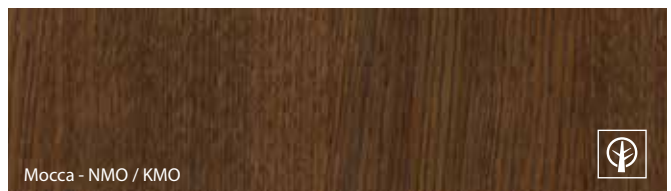

Mocca - NMO / KMO



Nero - NNE / KNE

Finishes key:

N- 'striped' wood grain
K- 'flower' wood grain

Certain veneer pattern is received thanks to proper wood selection, appropriate veneer leaf processing and its folding technique.
Striped - veneer with a consistent wood graining.
Flower (flader) - veneer with a natural, clear and patterned wood grain.

Due to the characteristic of natural veneers, differences in colour and graining, might appear on a door leaf.
These differences cannot be grounds for complaints.

WHITE COLOUR IS COMPARABLE WITH RAL

Natural veneer 'Select' - is a specially prepared and selected natural veneer characterized by high repeatability of the wood grain and colour. Products finished with this type of veneer meet the high quality standards.

Natural veneers: Oak Ash, Walnut and Satin Oak - are characterized by a variety of color, graining, etc. Their properties are the result of: natural environment of trees, climate, habitat conditions.
These morphological properties of wood, which are characteristic for a natural material, distinguish it from synthetic finishes and aren't defective in any way.

At Porta we do our best to create a perfect colour match of offered doorsets. However due to technology and materials slight differences may appear.



Finishes charts

Laminated steel sheet (PVC) ★★★★★☆



* until stocks last

Coated steel sheet ★★★★★☆☆

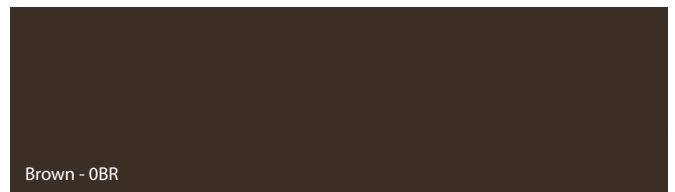
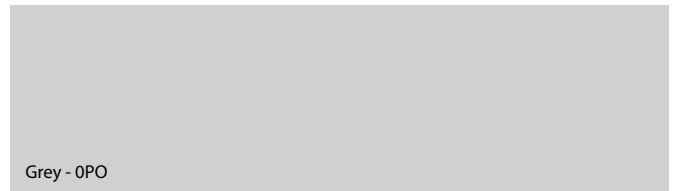
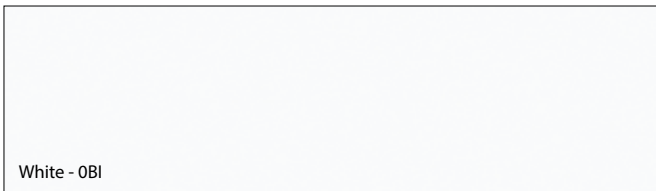

Due to type of used material, products colour are comparable to RAL colours.

White colour is comparable with RAL 9010 / Grey is comparable with RAL 7035

Anthracite is comparable with RAL 7024 / Brown is comparable with RAL 8017

Galvanized steel sheet ★★★★★☆☆













Stainless steel ★★★★★★★

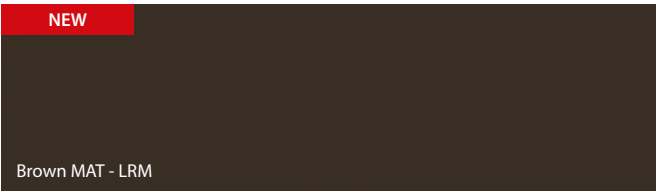

At Porta we do our best to create a perfect colour match of offered doorsets. However due to technology and materials slight differences may appear.

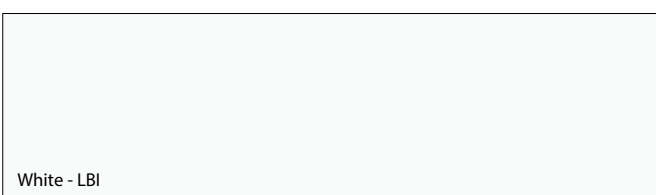
Finishes charts

Premium polyester paint ★★★★★☆

Group I	 <p>White MAT - LBM</p>	 <p>Grey MAT - LPM</p>
	 <p>Brown MAT - LRM</p>	 <p>Beige MAT - LKM</p>
	 <p>Anthracite HPL/CPL - LNC*</p>	 <p>Structured anthracite - LNT</p>
	 <p>White - LBI</p>	 <p>Grey - LPO</p>
Group II	 <p>Brown - LBR</p>	
	 <p>Black MAT - LCM</p>	

* HPL/CPL marking was introduced considering dedicated veneer Anthracite HPL/CPL

White colour (LBM) is comparable with RAL 9003 / White (LBI) is comparable with RAL 9016
 Grey (LPM, LPO) is comparable with RAL 7047/ Brown (LRM, LBR) is comparable with RAL 8028
 Beige (LKM) is comparable with RAL 1019/ Black (LCM) is comparable with RAL 9017
 Structured anthracite (LNT) is comparable with RAL 7024

Prime paint ★★★★★☆☆

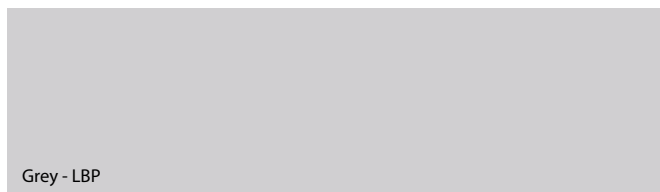

Prime paint - Grey (LBP) is comparable with RAL 7035

At Porta we do our best to create a perfect colour match of offered doorsets. However due to technology and materials slight differences may appear.

GLASS PANELS

GLASS PANEL TYPES



Frosted glass panel



'Chinchilla' glass panel



Frosted glass panel 'frame'



Villadora A glass panel



Villadora B glass panel



transparent glass panel

Dimensions szyb dostępne na www.porta.com.pl/do-pobrania

CUSTOMISE DOORS TO MEET YOUR INDIVIDUAL NEEDS.

DESIGN

Customize the door design to match the style and functionality of your interior.

FUNCTION

Customise functional properties of The doors To a room and a building.

PARAMETERS

Customize parameters to meet the requirements of architectural design.

COLOUR

Customise the door colour to match the surroundings.



Wide range of products is available both in standard and non-standard options.

More inspiration and and advices in Porta catalogues: www.portadoors.com/do-pobrania

5*
YEAR
WARRANTY

5 YEAR*

WARRANTY ON ALL PRODUCTS

36 MONTHS

FOR DOOR LEAVES AND DOOR FRAMES

+ ADDITIONAL
24 MONTHS

WHEN USING AUTHORIZED
ASSEMBLY GROUPS



**DETAILED REGULATIONS OF THE
PROGRAM ARE AVAILABLE AT:**

<https://www.porta.com.pl/dm/regulamin5lat.pdf>

IF YOU ARE LOOKING FOR:

- HIGH QUALITY DOORS
- INNOVATIVE DESIGN
- PRODUCTS WITH CERTIFICATES AND TECHNICAL APPROVALS
- TESTED INVESTMENT SOLUTIONS
- EXTENSIVE DISTRIBUTION NETWORK IN POLAND AND ABROAD
- PROFESSIONAL AFTER-SALES SERVICE

**YOU WILL FIND IT
IN THE PORTA DOORS
PORTFOLIO**

* EXTERIOR, WOODEN DOORS
warranty 24+12 months (with assembly)

PORTA KMI Poland LLC LP

Szkolna 54, 84-239 Bolszewo, Poland

S.C. PORTA KMI România S.R.L.

Zona Industrială Arad Nord – Vest, Strada III, Nr. 11, 310491 Arad

www.portadoors.ro, e-mail: info_doors@porta.com.pl

CUI: RO15624380, J02/910/2003, Capital social: 49.949.090 RON



- PORTA's factories
- PORTA dealers network