

COMPONGO

3.0



ARMADI

WARDROBES / CABINETS



COMPONGO 3.0

Indice

Contents
Sommaire

- p. 6 Gamma
- p. 8 Gamma
- p. 12 Gamma
- p. 16 Tratto
- p. 20 Delta
- p. 24 Delta
- p. 28 Line
- p. 32 Boma
- p. 36 Boma
- p. 40 Beta
- p. 44 Dub
- p. 50 Raggio
- p. 54 Alfa
- p. 58 Pop
- p. 60 Line V2, Vola
- p. 64 Penta V2
- p. 66 Soffio
- p. 70 Flap
- p. 74 Open



p. 78 Smart working

- 80 Penta, Board, Riflesso
- p. 84 Vola
- p. 86 Dub
- p. 88 Penta
- p. 92 Tratto
- p. 94 Flap



p. 4 Battenti Hinged door wardrobes Portes battantes



- p. 98 Risiko
- p. 102 Risiko
- p. 106 Vela
- p. 110 Vela
- p. 112 Vela
- p. 114 Bit
- p. 118 Blues
- p. 122 Podio
- p. 126 Rock
- p. 130 Twist
- p. 134 Folk
- p. 136 Folk
- p. 140 Profilo
- p. 142 Profilo
- p. 144 Riga
- p. 146 Totem
- p. 150 Board
- p. 154 Board, Riflesso
- p. 156 Capitol
- p. 158 Drift
- p. 162 Drift
- p. 166 Riquadro
- p. 168 Riquadro



p. 96 Scorrevoli Sliding door wardrobes Portes coulissantes



Battenti

Hinged door wardrobes

Portes battantes



GAMMA





GAMMA

Notte

Armadi

Graniglia scura



Insieme al Graniglia chiara entra a far parte delle novità.

New entry together with Graniglia Chiara.

C'est une nouveauté avec la finition Graniglia chiara.

Noce moro



New entry nel progetto Compongo 3.0 e nella famiglia Imab.

New addition to the Compongo 3.0 project and the Imab family.

Nouvelle entrée dans le projet Compongo 3.0 et dans la famille Imab.

Grigio seta



Finitura che permette l'abbinamento dei colori sempre nel segno del design.

Finish which enables stylish colour combinations.

Finition qui permet une combinaison de couleurs sous le signe du design.

Compongo 3.0

RQM034

Gamma

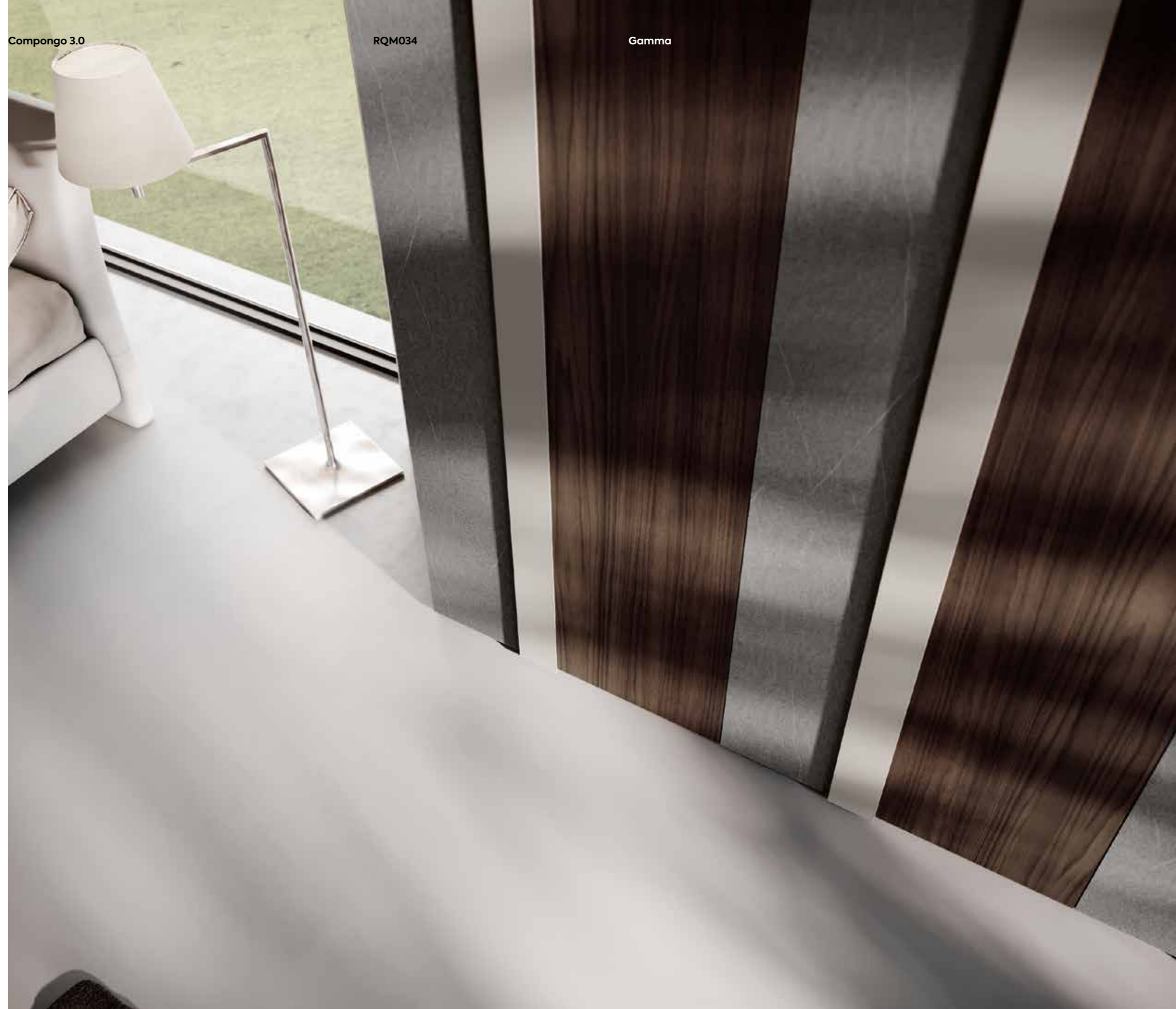



GAMMA



Disponibile in 11 finiture

Available in 11 finishes

Disponible en 11 finitions

Bianco altea
 Olmo natura
 Noce biondo
 Noce moro
 Bianco
 Agave
 Grigio cenere
 Grigio seta
 Orzo
 Petrolio
 Visone



La maniglia Gamma, a tutta altezza, è disponibile nelle essenze e colorati della collezione.

The full-height Gamma handle is available in all the collection wooden effects and colours.

La poignée Gamma, pleine hauteur, est disponible dans les finitions effets bois et colorées de la collection.

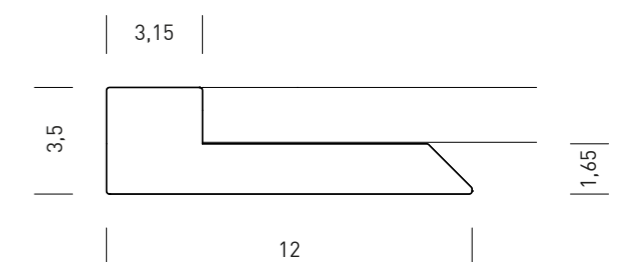

TRATTO

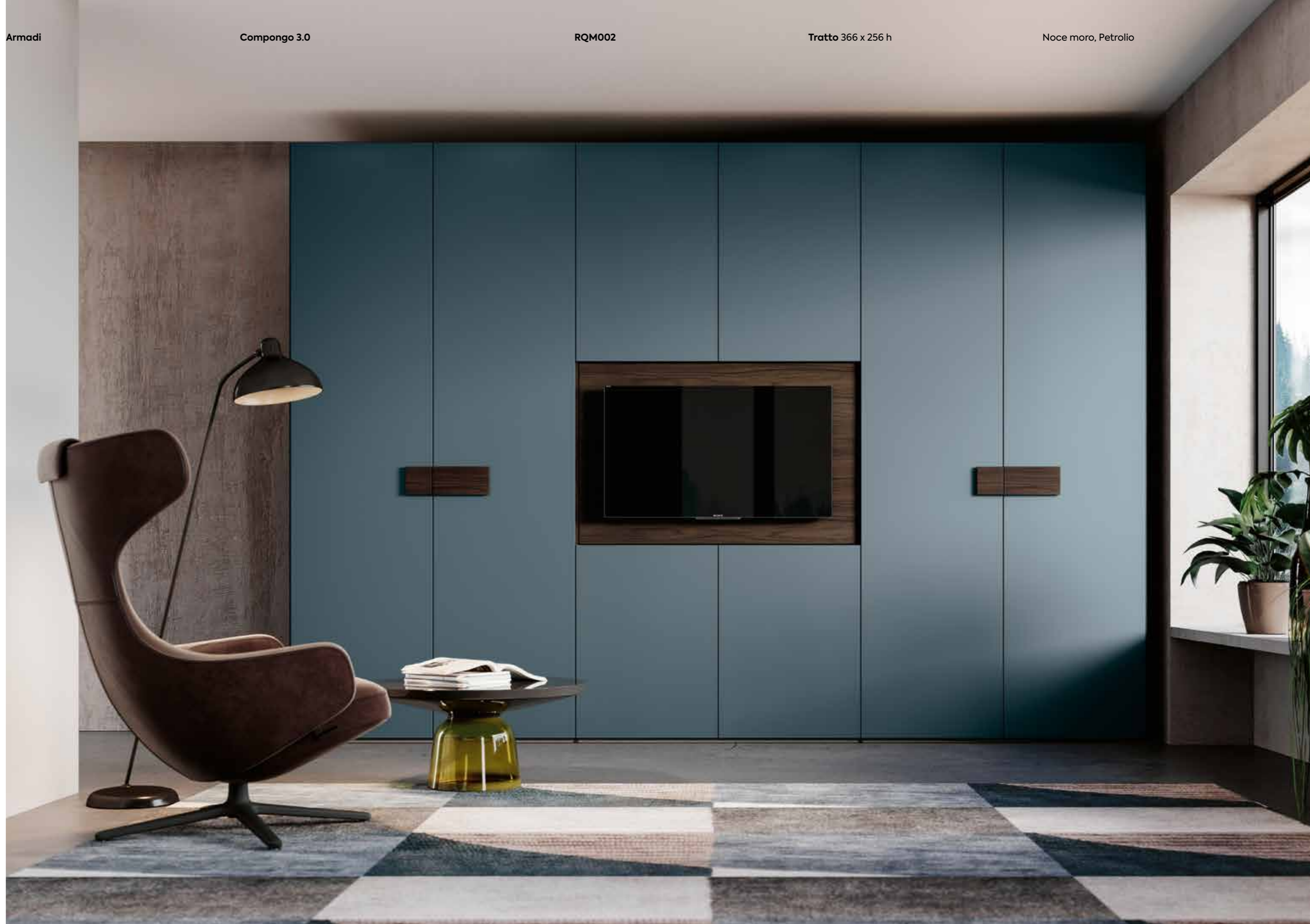



Noce moro



La nuova finitura
Noce moro, veste
in modo distintivo
e raffinato la maniglia
Tratto, dal design lineare
e dai dettagli sofisticati.

The new Noce Moro finish
bestows a distinctive,
refined look on the simple
yet sophisticated
Tratto handle.

La nouvelle finition
Noce Moro habille
avec distinction et finesse
la poignée Tratto
au design linéaire
et aux détails
sophistiqués.



Il Porta-tv girevole
nasconde una pratica
libreria, ricavando
spazio per l'ordine
degli indumenti.

The swivel TV panel
conceals a handy
bookcase, creating space
for keeping clothes tidy.

Le support-tv pivotant
cache une étagère
pratique en créant
de l'espace pour ranger
les vêtements.



DELTA

Graniglia chiara



Nuovo ingresso
tra la vasta gamma
delle finiture.

A fresh entry amongst
the vast range of finishes.

Nouvelle entrée
dans la vaste gamme
de finitions.

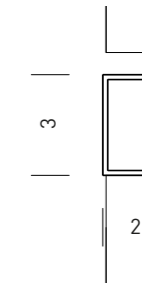

La pratica maniglia Delta
entra come novità
per il suo utilizzo
nei cestoni.

The convenient Delta
handle is a new feature
for use on storage
drawers.

La poignée pratique
Delta fait partie
des nouveautés à utiliser
sur les grands tiroirs.

DELTA

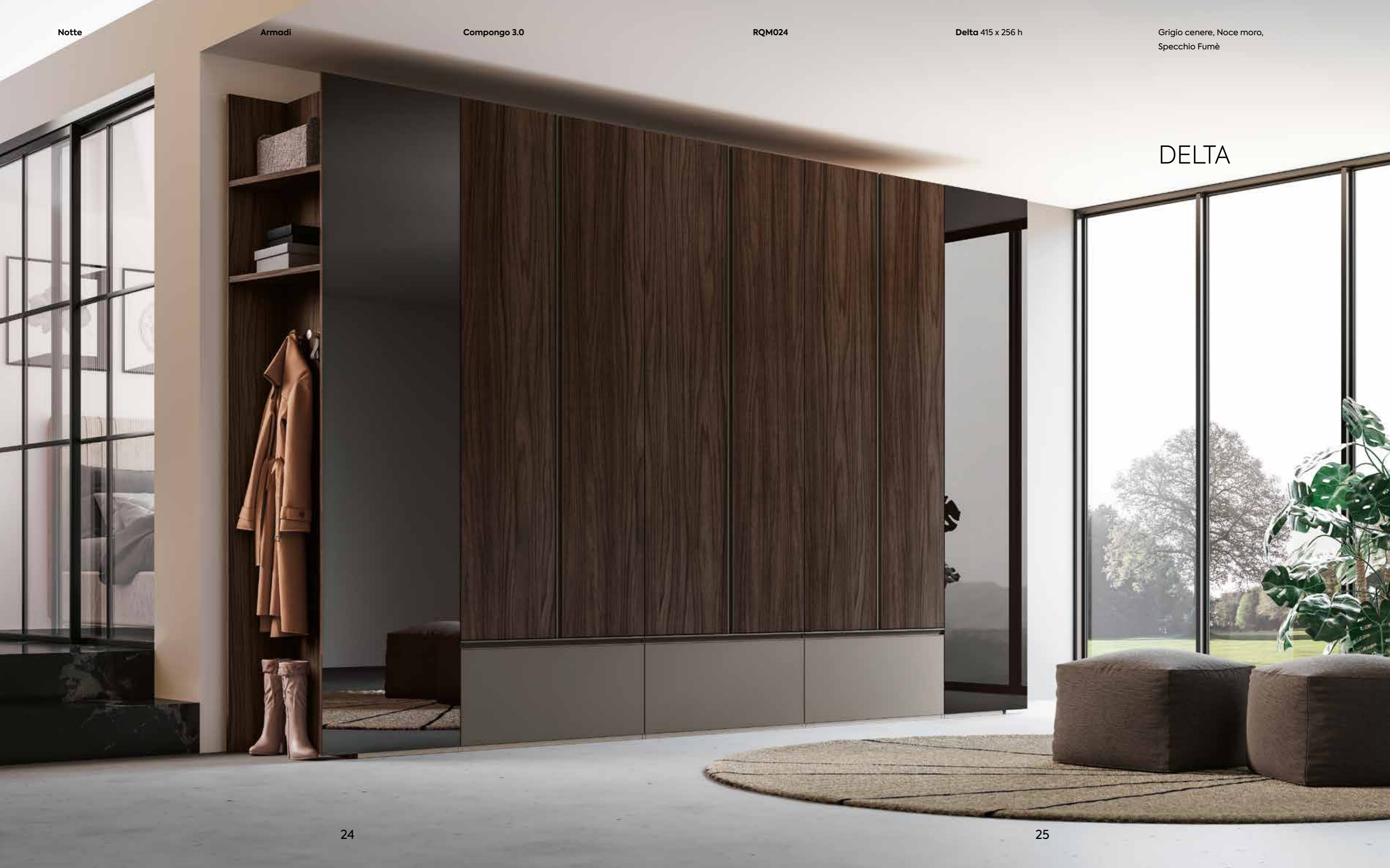



L'armadio è caratterizzato da 2 terminali aperti, con un grande impatto estetico e funzionale.

The wardrobe is characterised by 2 open end sections, with great impact in terms of both looks and function.

L'armoire est caractérisée par 2 extrémités latérales ouvertes ayant un grand impact esthétique et fonctionnel.



La maniglia Delta, dallo spessore sottile applicata al profilo dell'anta, garantisce una corretta presa e una facile apertura a chiunque, adulti e bambini.

The slimline Delta handle applied to the edge of the door ensures that anyone, both adults and children, can grip and open it easily.

La poignée Delta, très fine, appliquée au profil de la porte, assure que quiconque, aussi bien un adulte qu'un enfant, puisse la saisir aisément pour ouvrir facilement la porte.

LINE

ONDA





Notte

Armadi

Compongo 3.0

RQM033

Line

Fa il suo ingresso come novità nel progetto Compongo 3.0, la pratica ed ergonomica maniglia Line.

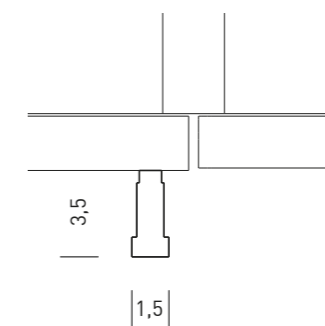

The practical, ergonomic Line handle is a novelty in the Compongo 3.0 project.

La poignée Line, pratique et ergonomique, fait son entrée comme nouveauté dans le projet Compongo 3.0.

BOMA



La maniglia Boma sormonta l'anta andando a coprire la fuga.
È disponibile in tutte le essenze e nobilitati.

The Boma handle overlaps the edge of the door to cover the gap.
It is available in all wooden effect and melamine finishes.

La poignée Boma surmonte la porte et cache l'espace entre les battants.
Elle est disponible dans tous les effets bois et les finitions en mélaminé.

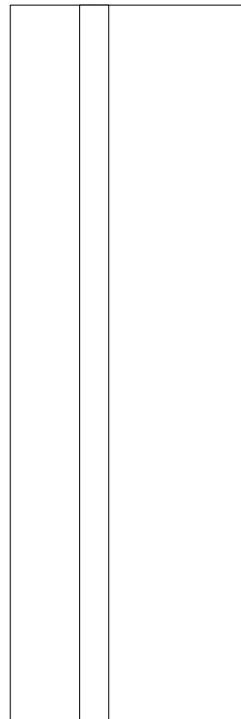

30

60



BOMA



La maniglia Boma facilita l'apertura garantendo una superficie liscia e una pulizia estetica che donano un impatto visivo elegante ed essenziale.

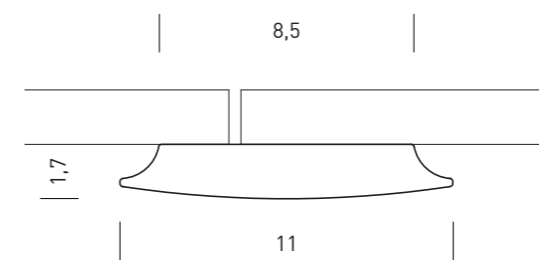

The Boma handle combines easy opening with a smooth surface and simple line that ensure an elegant, essential visual impact.

La poignée Boma facilite l'ouverture en garantissant une surface lisse et une ligne simple qui donnent un impact visuel élégant et essentiel.



BETA



Una soluzione speciale è quella dell'elemento sopraporta, con ante apertura battente, disponibile in 2 larghezze: 90 cm e 120 cm.

One special solution is the door bridge element, with hinged doors, available in 2 widths: 90 cm and 120 cm.

Une solution spéciale est celle de l'élément surmontant la porte à deux battants qui est disponible en 2 largeurs : 90 cm et 120 cm.

DUB

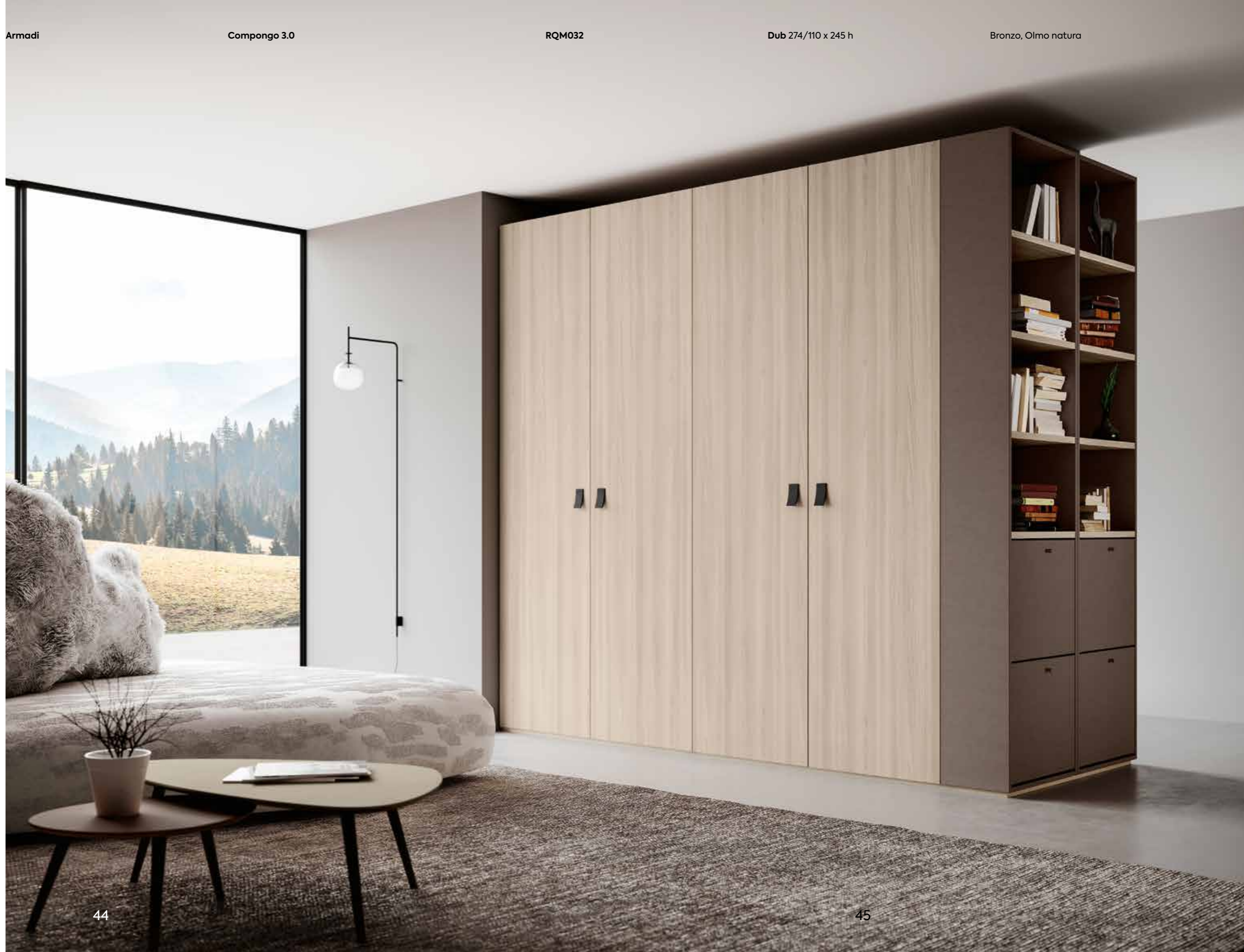



Armadio efficace e razionale contenitore che si adatta a molteplici esigenze, per avere tutto in un'unica soluzione. Il terminale è completo di vani libreria e una comoda scarpiera integrata.

An effective wardrobe providing rational storage, suitable for a wide variety of needs, with everything in a single solution. The end unit is complete with bookcase compartment and a handy integral shoe rack.

Voilà une armoire efficace permettant un rangement rationnel ; elle s'adapte à de multiples exigences pour tout avoir en une seule solution. L'extrémité latérale est équipée d'une bibliothèque et d'un rangement-chaussures.

Il design e l'estetica della maniglia Dub propongono nuovi equilibri visivi.

The design and style of the Dub handle offer new visual equilibria.

Le design et l'esthétique de la poignée Dub proposent de nouveaux équilibres visuels.



RAGGIO



Di grande impatto grafico è la maniglia, che si configura come un taglio verticale che rafforza la bellezza della composizione.

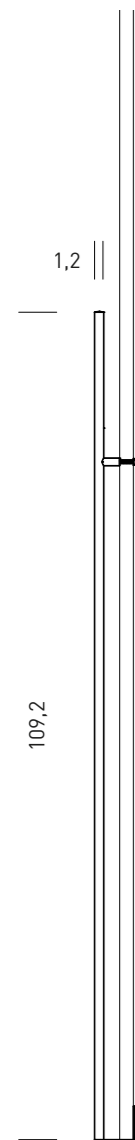

The handle has immense graphic impact, a slender vertical line that reinforces the beauty of the composition.

La poignée, qui assure un fort impact graphique, se présente comme une coupe verticale qui renforce la beauté de la composition.

ALFA



La maniglia Alfa è composta da due elementi: uno da 30 e l'altro da 120cm. Disponibile solamente nelle essenze, le cui venature la rendono lussuosa, eccentrica ed elegante.

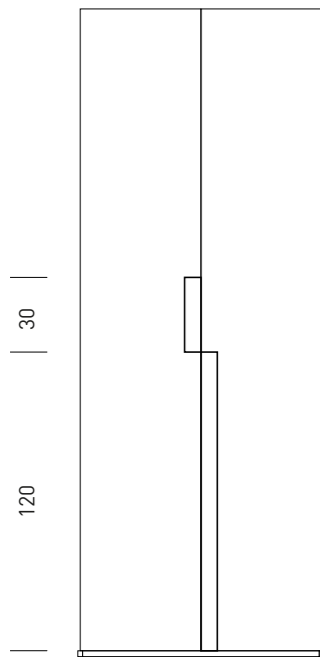

The Alfa handle comprises two parts: one of 30 and the other of 120 cm. Only available in the wooden effects and made luxurious, eccentric and elegant by their vein patterns.

La poignée Alfa est composée de deux éléments : un de 30 cm et l'autre de 120 cm. Elle n'est disponible que dans les finitions effets bois dont les veinures la rendent luxueuse, excentrique et élégante.



POP

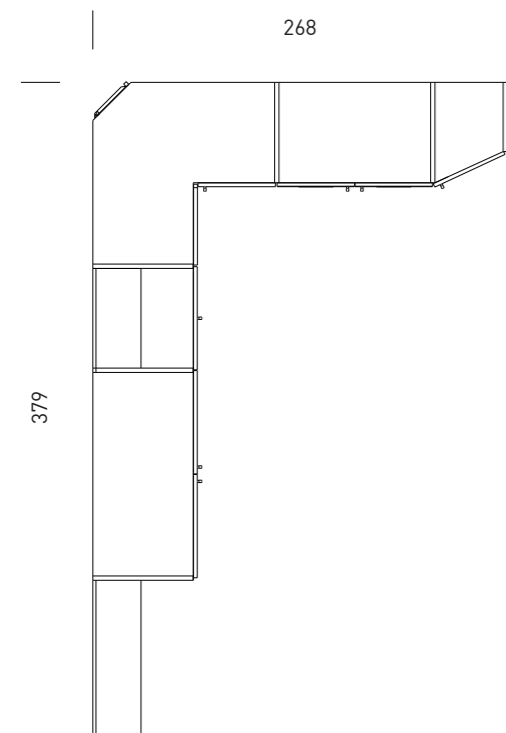



LINE V2
VOLA

Non serve chissà quale spazio per dotare il proprio armadio di una vera cabina-spogliatoio. È sufficiente l'attento calcolo delle proporzioni per inserire un modulo più profondo: le ante specchio nascondono una cabina armadio dotata di attrezzaggio interno con mensole, specchio, cassettera e ripiani.



You don't need huge amounts of space to include a changing cubicle in your wardrobe. You simply calculate the proportions carefully to insert a deeper module: the mirror doors conceal a walk-in section equipped on the inside with shelves, mirror, drawer unit and tops.

Il ne faut pas beaucoup d'espace pour doter une armoire d'une cabine d'habillage. Il suffit de calculer attentivement les proportions pour insérer un module plus profond : les portes-miroir cachent une cabine dotée d'étagères, d'un miroir, de tiroirs et de tablettes.







SOFFIO



La maniglia Soffio è disposta per tutta l'altezza dell'armadio e, così come la maniglia Boma, sormonta le ante coprendo le fughe.

The Soffio handle covers the full height of the wardrobe and, like the Boma handle, overlaps the edge of the doors, covering the gap.

La poignée Soffio est placée sur toute la hauteur de l'armoire et, comme la poignée Boma, elle surmonte la porte et cache l'espace entre les battants.



FLAP

La zona cassetti e cesti è completamente modulare, adatta a creare spazi personalizzati e dotata della nuova maniglia Flap, disponibile in Nero e Titanio.

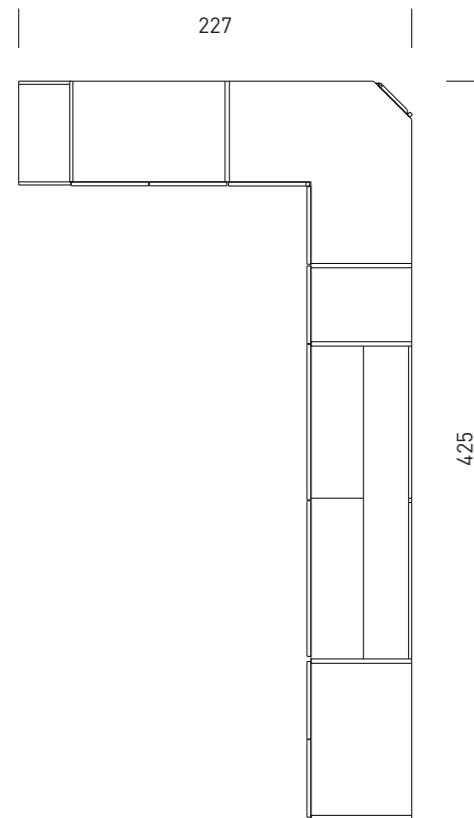

The drawer and storage drawer zone is completely modular, ideal for creating personalised spaces and featuring the new Flap handle, available in Nero and Titanio.

La zone des tiroirs et des grands tiroirs est entièrement modulaire, elle permet de créer des espaces personnalisés et elle est dotée d'une nouvelle poignée Flap disponible en Nero et Titanio.





OPEN



L'armadio si completa con accessori che rendono pratici anche gli spazi più alti. Il servi abito infatti è l'ascensore nell'armadio, lo scopo principale del sistema è l'ottimizzazione e la fruizione degli spazi interni.

The wardrobe is completed by accessories that make even the highest spaces convenient. With the pull down clothes rail all internal spaces can be optimised and used.

L'armoire est complétée par des accessoires qui facilitent l'accès aux espaces en hauteur. En effet, la barre penderie rabattable est un « ascenseur » à l'intérieur de l'armoire, ce système a pour but d'optimiser l'utilisation des espaces internes.

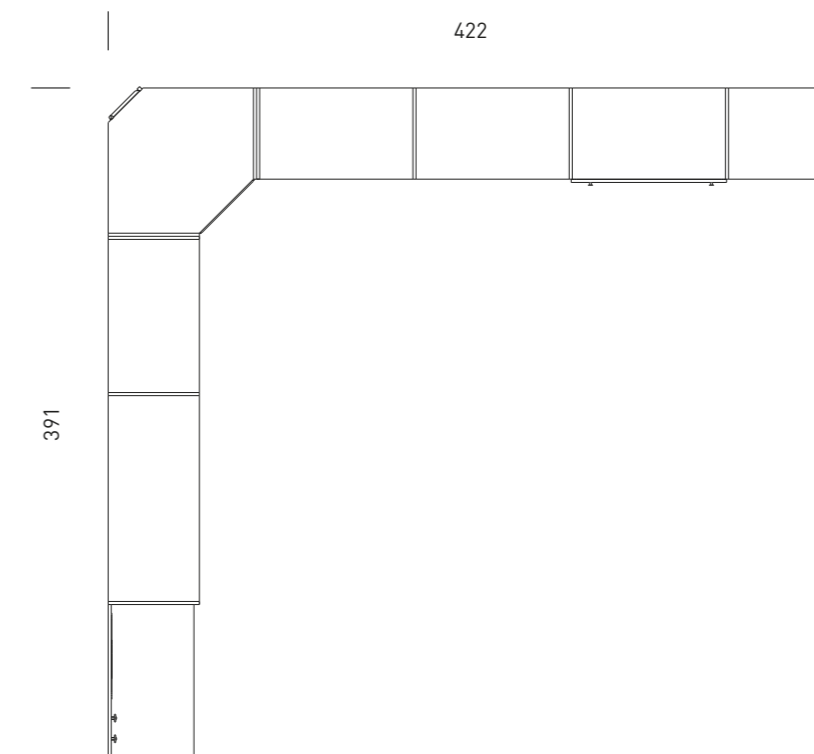

Raffinatezza dei dettagli e impatto visivo connotano anche gli spazi dedicati al contenimento.

Refined details and visual impact even in storage spaces, with handles with simple yet striking design.

Le raffinement des détails et l'impact visuel caractérisent aussi les espaces de rangement avec des poignées au design essentiel.

Smart working





PENTA

BOARD
RIFLESSO

Una proposta di arredo per risolvere una zona Smart working funzionale e adatta ad ogni esigenza.

A furnishing range for constructing a functional smart working zone able to meet all needs.

Voici une proposition pour aménager un coin télétravail fonctionnel qui répond à tout besoin.

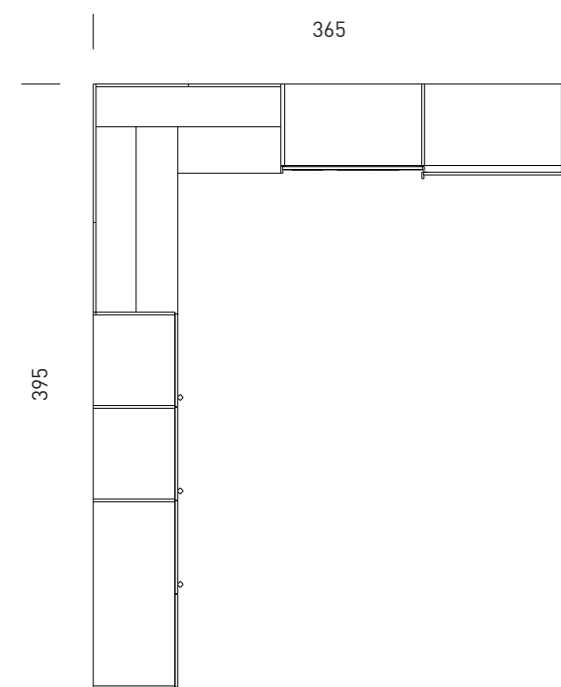

VOLA

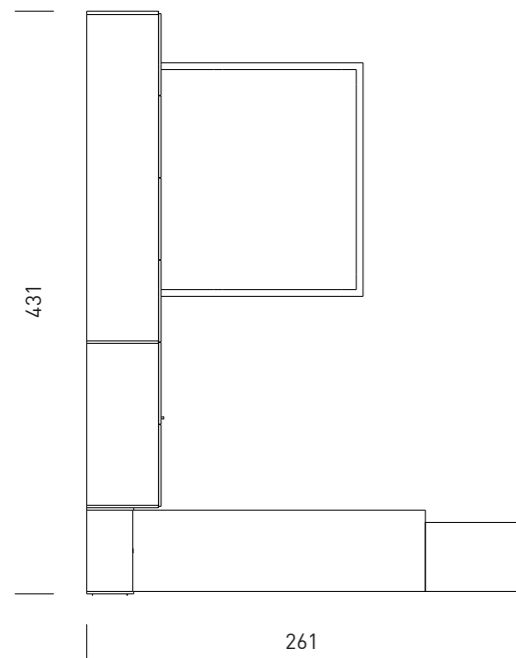



DUB

PENTA



Questa proposta prevede la zona Smart working a scomparsa, disegnata per sorprendere, ideale per chi ama l'ordine.

In this solution, the smart working zone is concealed, designed to surprise, ideal for people who like everything to be neat and tidy.

Cette proposition prévoit un coin télétravail escamotable conçu pour surprendre ; c'est l'idéal pour ceux qui aiment l'ordre.

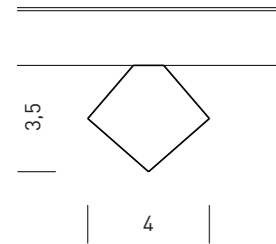

TRATTO

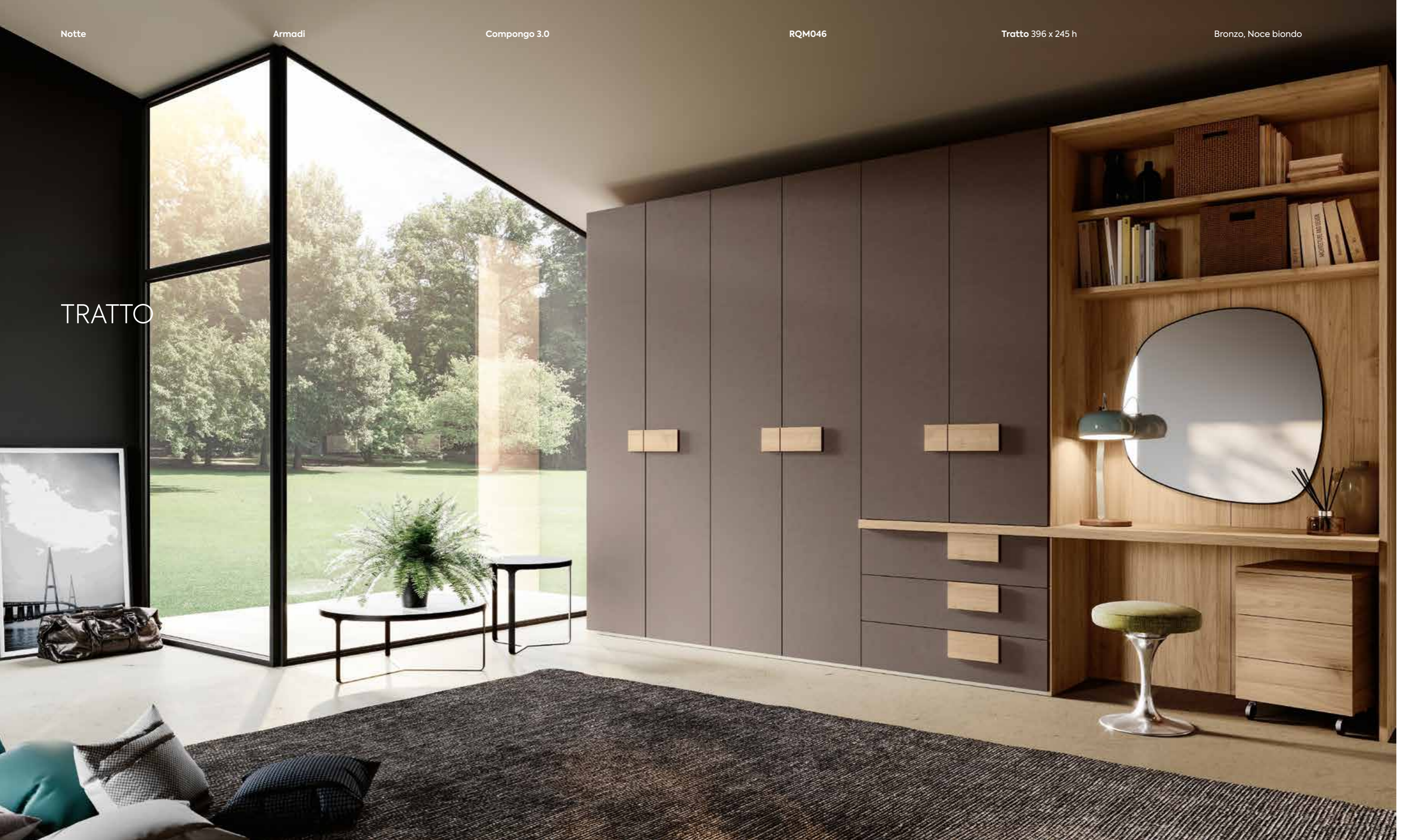



FLAP

Per la zona studio,
una soluzione smart
con vasistas attrezzabile
con illuminazione
sottopensile.

For the study zone,
a smart working solution
with flap door wall unit
that can be fitted
with midway lighting.

Pour le coin bureau,
voici une solution smart
avec vasistas
pouvant être équipé
d'une réglette d'éclairage.

Scorrevoli

Sliding door wardrobes

Portes coulissantes



RISIKO



La possibilità di personalizzare l'armadio Risiko con un gioco di finiture, è una soluzione versatile e originale, ritagliata sulla personalità di chi lo sceglie. I colori delle cartelle possono essere scelti singolarmente, generando composizioni cromatiche di grande stile.



The Risiko wardrobe can be personalised through creative use of its finishes; this is a versatile, original solution, reflecting each user's individual character. The door panel colours can be chosen one by one to generate very stylish chromatic compositions.

La possibilità di personaliser l'armoire Risiko avec un jeu de finitions est une solution polyvalente et originale qui permet de refléter le caractère individuel de l'utilisateur. Pour chaque panneau de porte, on peut choisir une couleur différente ce qui permet de réaliser des compositions chromatiques très élégantes.

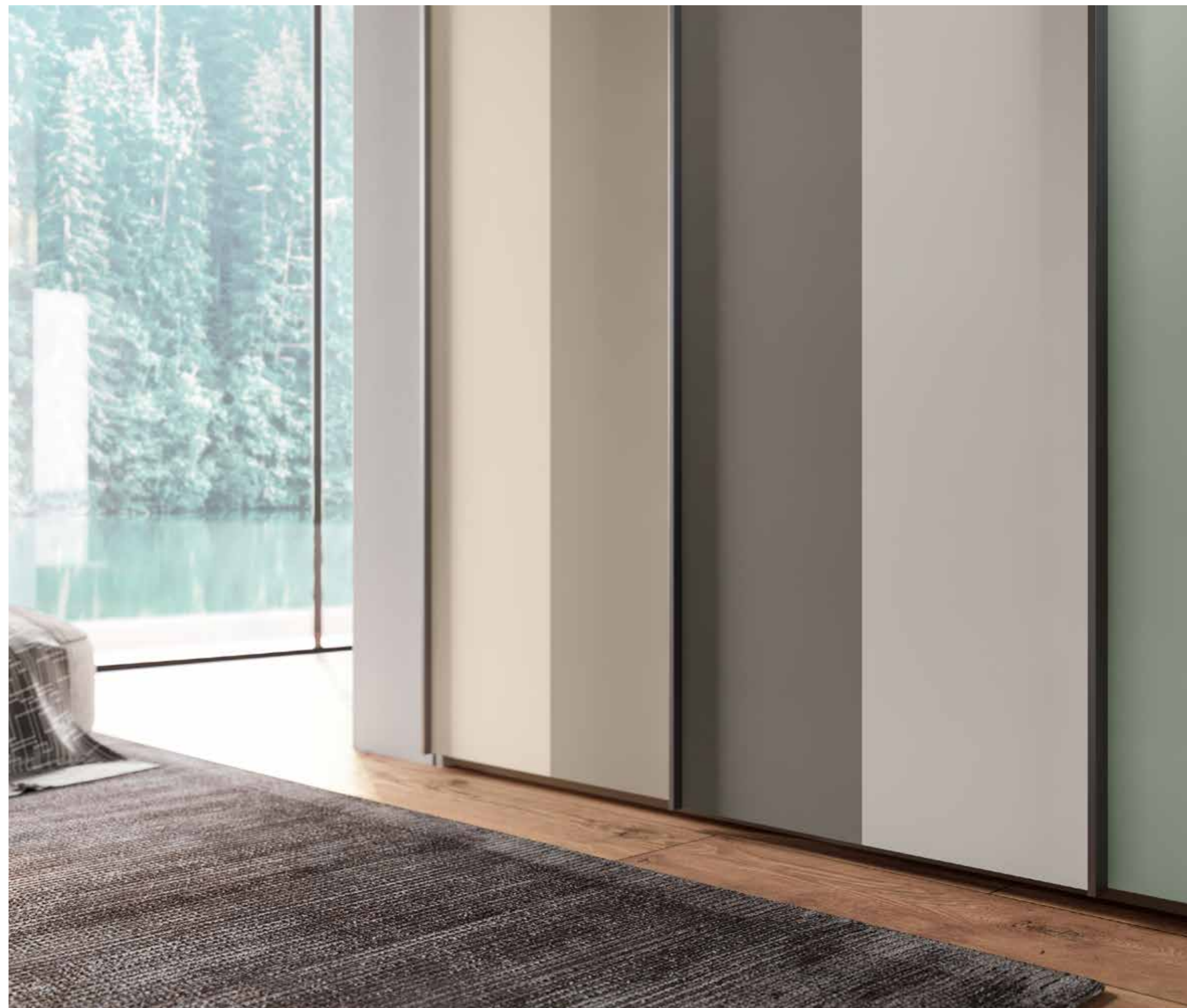

Notte

Armadi

Compongo 3.0

RQM004

Risiko 368 x 256 h

Argilla, Bronzo, Specchio Fumè

RISIKO



Tratti eleganti ed essenziali, esaltati dalla presenza delle ante specchio Fumè.

Elegant and essential lines, emphasised by the Fumè mirror door.

Les lignes élégantes et essentielles sont exaltées par la présence de portes-miroir Fumè.



VELA



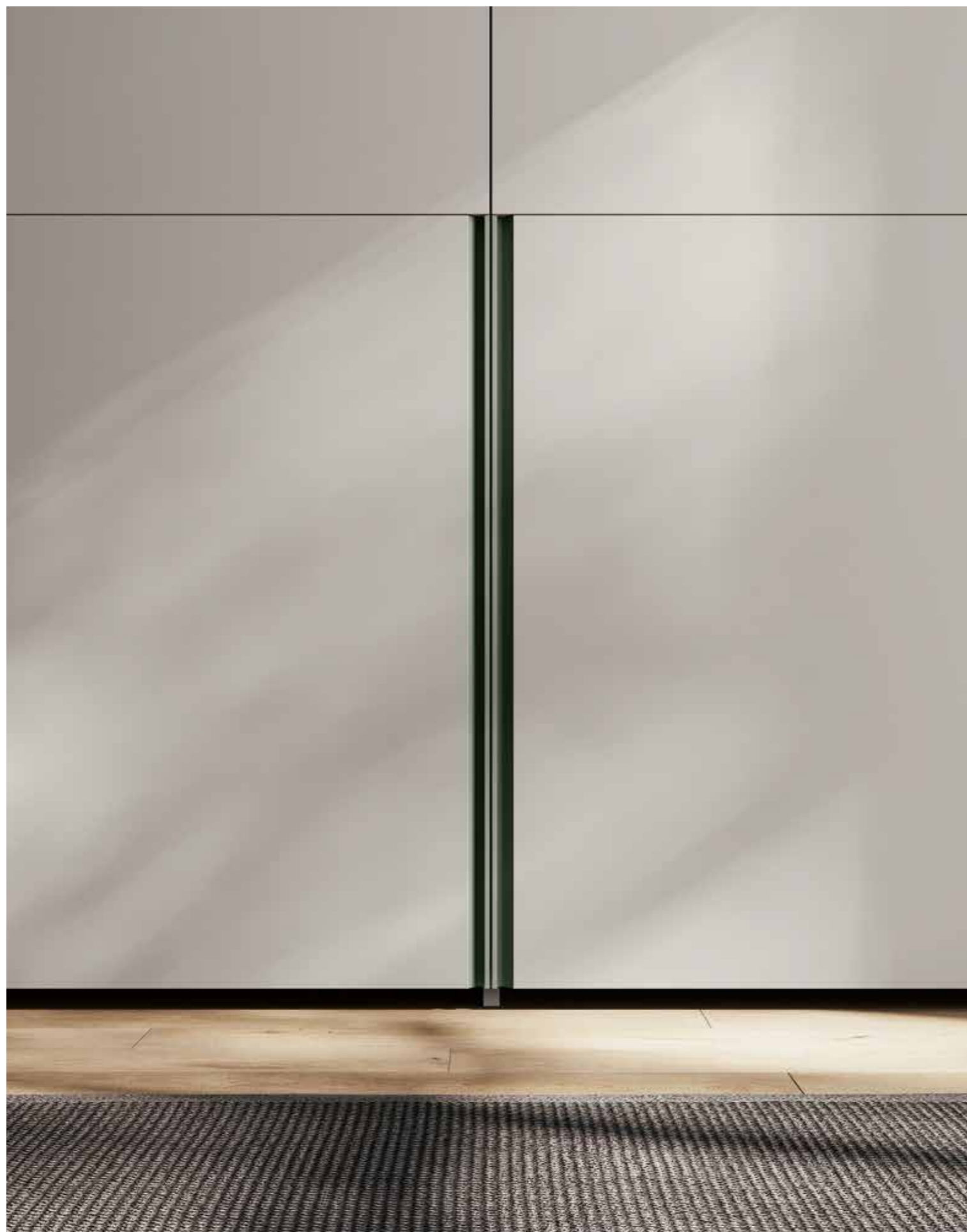

La maniglia Vela può diventare un dettaglio valorizzabile o mimetizzabile in base al colore scelto. La scanalatura permette una presa sicura, nella sua versione ad apertura scorrevole: una convivenza imbattibile quella tra minimalismo estetico e funzionalità.

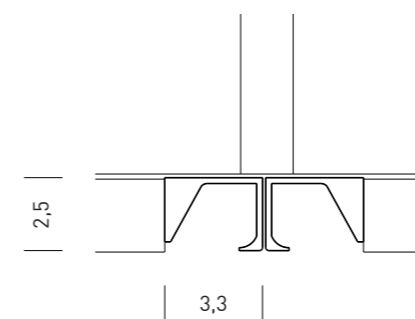

The Vela handle is a detail which may be highlighted or camouflaged, depending on the colour chosen. The groove enables a secure grip in the sliding door version: an unbeatable combination of aesthetic minimalism and absolute practicality.

La poignée Vela est un détail qui, en fonction de la couleur choisie, peut soit être mis en évidence soit se mimétiser. La rainure assure une bonne prise dans la version à ouverture coulissante : voilà une combinaison gagnante entre le minimalisme esthétique et la fonctionnalité.

VELA







BIT

Grigio seta



La finitura descrive uno stile elegante e chic, che abbinato alle essenze introduce un concetto di grande modernità.

The finish defines an elegant, chic style, which combines with the wooden effects to add an extremely modern touch.

La finition décrit un style élégant et chic qui, associé aux effets bois, introduit un concept de grande modernité.

Rovere tabacco



Abbinalo con i colorati e trova il tuo benessere in un ambiente caldo e rassicurante.

Mix it with the coloured finishes to style your own well-being in a warm, reassuring bedroom.

Associez-le aux différentes finitions colorées et vous trouverez votre bien-être dans une chambre chaleureuse et rassurante.

BLUES*





* **L'anta da 90cm con inserto specchio Fumè da 30, arricchisce l'armadio di riflessi profondi, rendendo suggestivo ogni ambiente. L'anta Specchio è disponibile nelle finiture: Fumè, Bronzo e Neutro, e nelle finiture vetro: Marmo chiaro e scuro.**

* The 90 cm door with 30 cm Fumé mirror insert adds the depth of reflections to the wardrobe's appearance, adding fascination to any interior. The Mirror door is available in Fumé, Bronzo and Neutro finishes, and in Marmo Chiaro and Marmo Scuro glass finishes.

* La porte de 90 cm avec insert à miroir Fumé de 30 cm enrichit l'armoire de reflets profonds en rendant suggestive chaque chambre. La porte-miroir est disponible dans les finitions Fumé, Bronzo et Neutro ainsi que dans les finitions de verre : Marmo chiaro et Marmo scuro.

PODIO

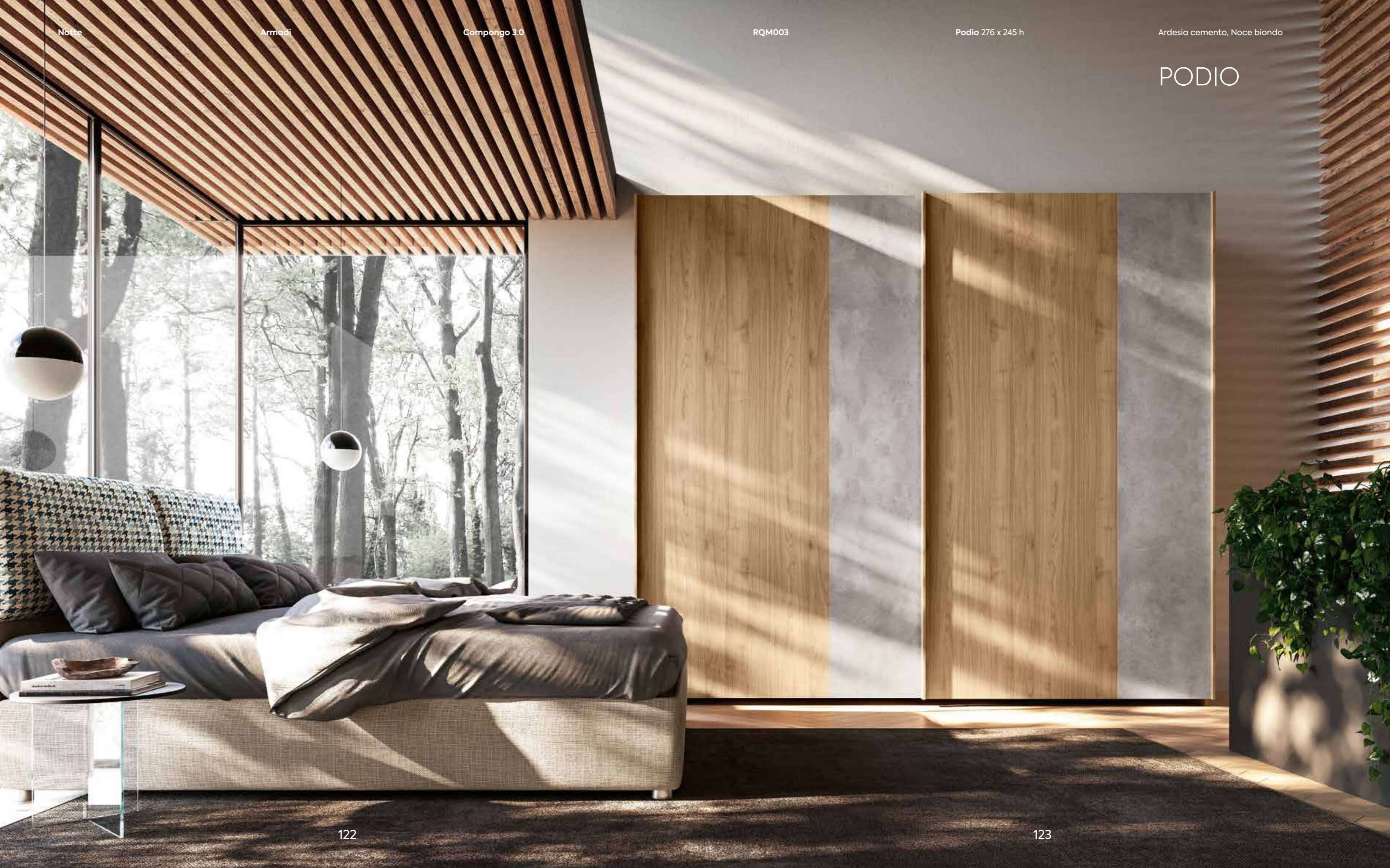



Noce biondo



L'essenza arricchisce la composizione, con la sua venatura dai tratti distintivi.

The wooden effect enhances the composition with its distinctive vein patterns.

L'effet bois enrichit la composition avec le dessin caractéristique des veinures.

Ardesia Cemento



Nuova finitura effetto spatolato che offre la possibilità di abbinamento con essenze e colorati.

New faux plaster effect finish with great potential for combinations with the wooden effects and colours.

Nouvelle finition à l'aspect spatulé pouvant être associée à des effets bois et des finitions colorées.

ROCK*



*Novità / News / Nouvelle

* **Nuovo armadio Rock.**
La combinazione di più colori
permette di creare soluzioni
che rispondono alle esigenze
di camere e camerette
di ogni tipo.

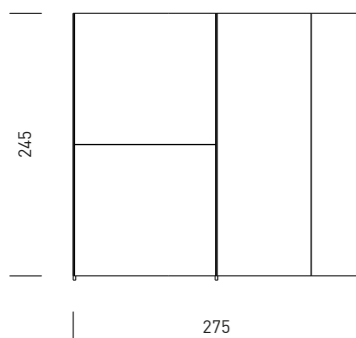

* **New Rock wardrobe.**
 Several colours can be combined
 to create solutions to suit adult
 and kids bedrooms of all kinds.

* **Nouvelle armoire Rock.**
 La combinaison de plusieurs couleurs
 permet de créer des solutions
 qui répondent aux exigences
 des chambres d'adultes
 et d'enfants de tout type.



TWIST



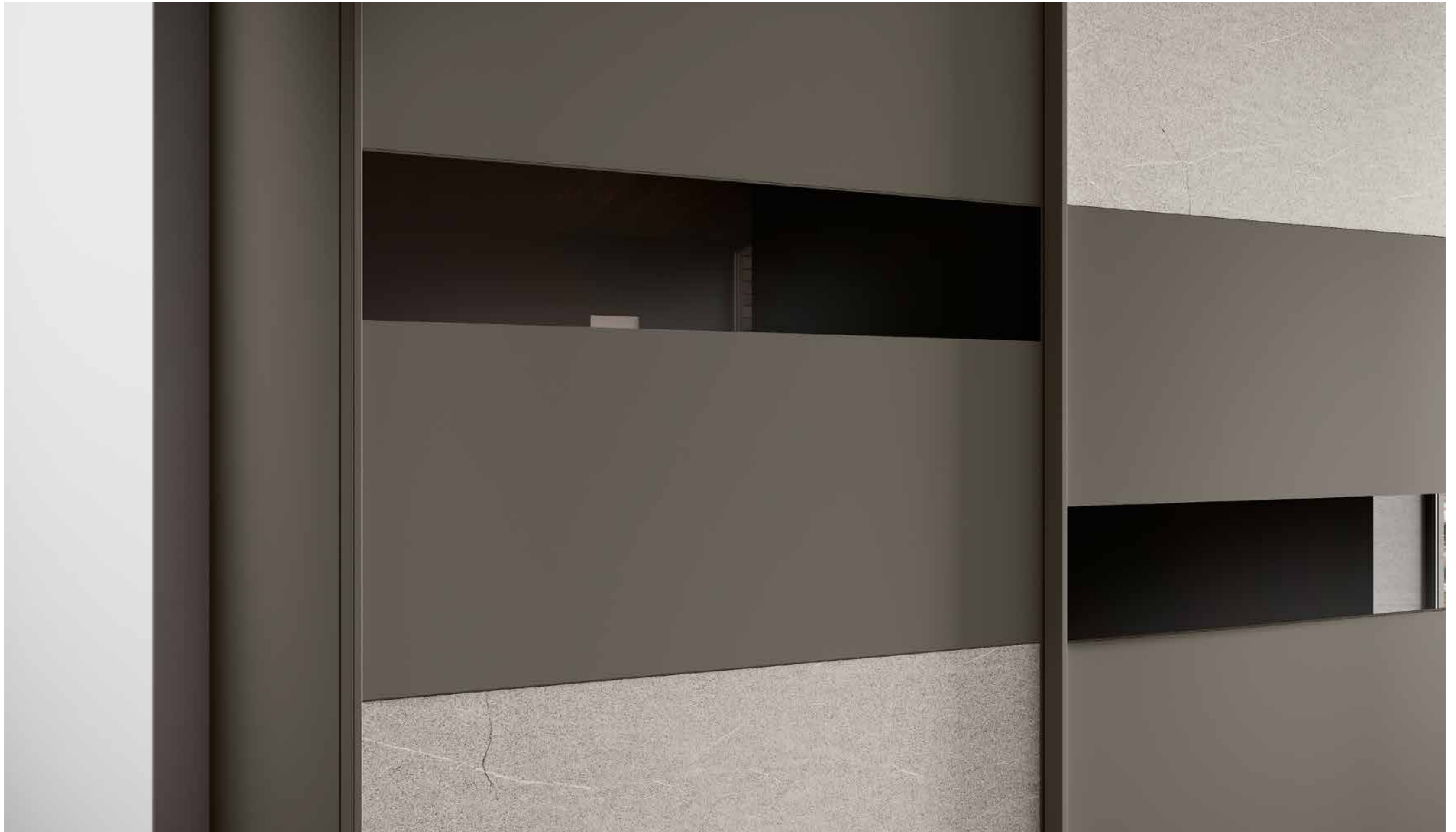

FOLK





* L'armadio Folk, caratterizzato da un inserto centrale che percorre orizzontalmente tutto l'armadio, è una novità nel progetto Compongo 3.0, ed è disponibile anche nelle 7 finiture inserto.

Disponibile anche nelle finiture inserto

Also available in the insert finishes

Disponible également dans les finitions d'inserts

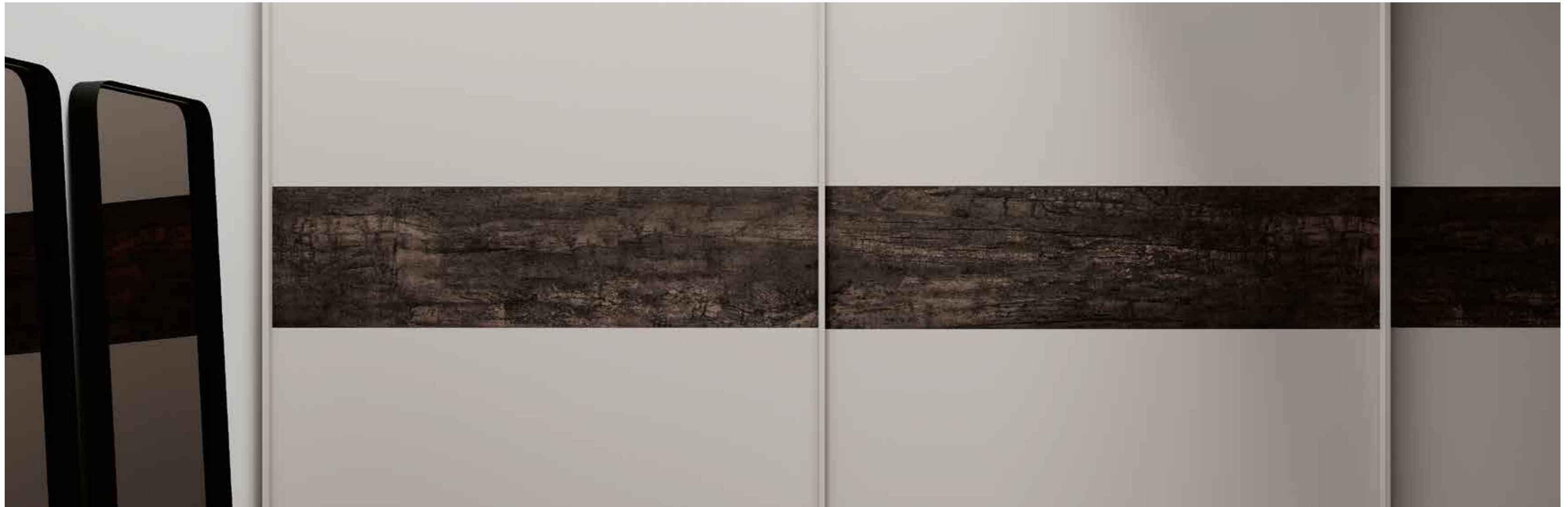

* The Folk wardrobe, with its central insert running horizontally across the entire composition, is a new addition to the Compongo 3.0 project, and is also available in the 7 insert finishes.

* L'armoire Folk, caractérisée par un insert central qui parcourt horizontalement toute l'armoire, est une nouveauté dans le projet Compongo 3.0 ; elle est aussi disponible dans les 7 finitions d'inserts.



Ardesia chiara
Ardesia scura
Ardesia cemento
Graniglia chiaro
Graniglia scuro
Legno bruciato
Rovere tabacco

Notte

Armadi

Compongo 3.0

RQM008

Profilo 368 x 245 h

Bronzo, Noce biondo

PROFILO

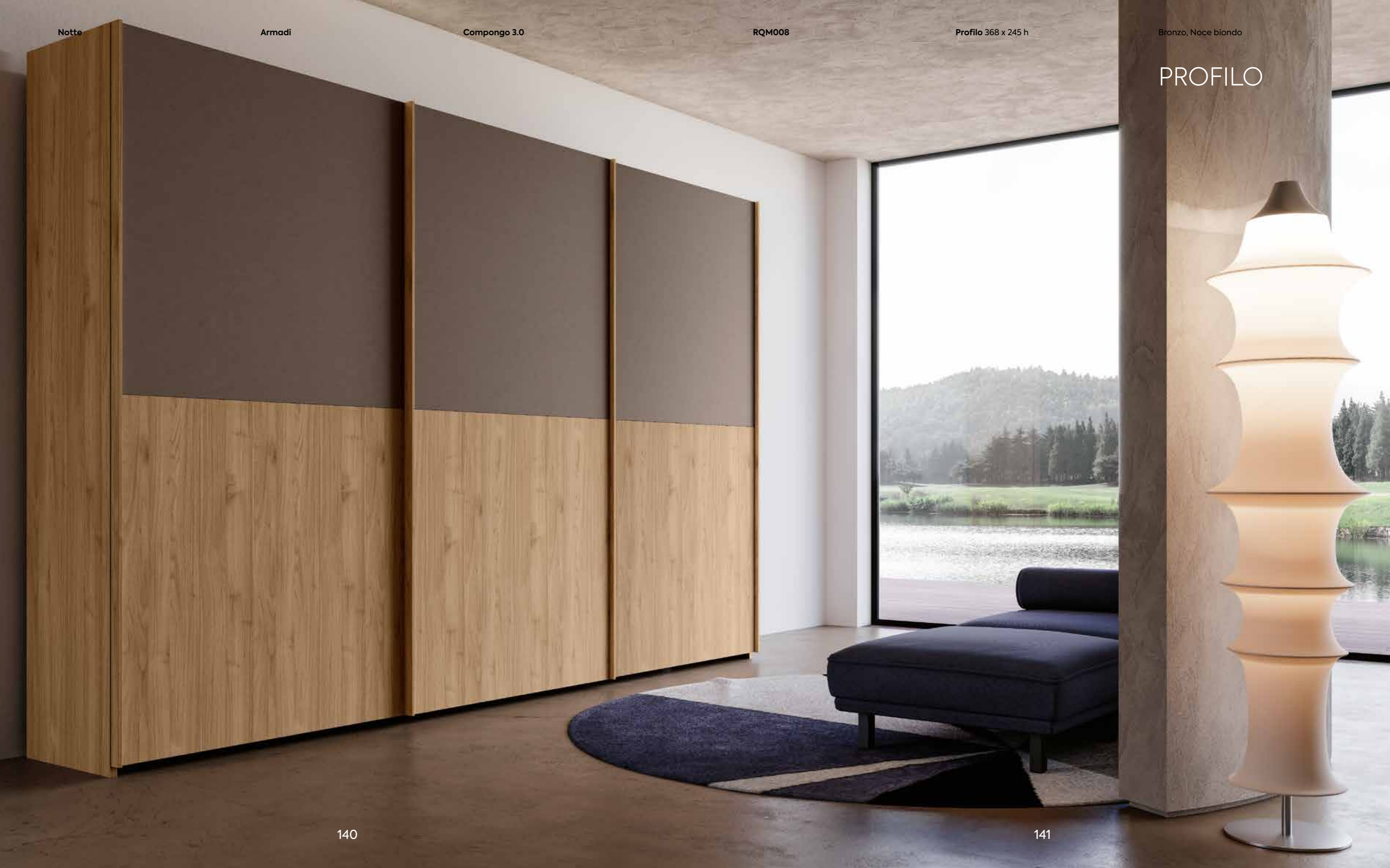



PROFILO



RIGA

TOTEM*



*Novità / News / Nouvelle

Gola disponibile nelle 4 finiture in essenza

Groove system available in the 4 wooden effect finishes

Gola est disponible dans les 4 finitions effets bois

* **Armonia tra legno e colore,
dove la gola è disponibile nelle 4 essenze,
per creare perfetti abbinamenti
e dare vita a diverse soluzioni.**



Bianco altea
Olmo natura
Noce biondo
Noce moro

* Wood and colour unite in harmony; the groove system is available in the 4 wooden effects, to create perfect combinations and various solutions.

* Le bois et la couleur se marient harmonieusement ; le système à rainure est disponible dans les 4 effets bois pour créer des combinaisons parfaites et obtenir des solutions différentes.

BOARD





Massima personalizzazione con la possibilità di scegliere colorazioni differenti dell'anta Board. Particolare attenzione è richiamata inoltre dal nuovo maniglione con sezione squadrata e minimale.

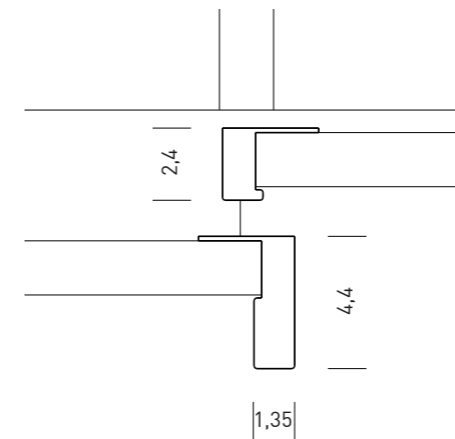

Utmost personalisation thanks to the different colours available for the Board door.
The new square-section handle in minimal style is another eye-catching feature.

La possibilità de choisir des coloris différents pour la porte Board assure une très grande personnalisation.
Par ailleurs, la nouvelle poignée minimale à section carrée est une caractéristique qui attire le regard.

BOARD RIFLESSO



CAPITOL





DRIFT

Giochi di geometrie caratterizzano l'armadio scorrevole, il cui inserto centrale è presentato nella nuova finitura Graniglia scura e anche disponibile in tutte le finiture inserto.

Geometrical effects for this sliding-door wardrobe, with central insert in the new Graniglia Scura finish and also in all the insert finishes.

Les effets géométriques caractérisent l'armoire à portes coulissantes dont l'insert central, qui est ici présenté dans la nouvelle finition Graniglia Scura, est aussi disponible dans toutes les finitions d'inserts.



DRIFT



Drift propone
una comoda cassettiera
integrata in armonia
con il design dei frontali.

Drift includes
a convenient integrated
drawer unit, matching
the design of the fronts.

Drift propose
un ensemble de tiroirs
intégré qui s'harmonise
avec le design
des panneaux frontaux.

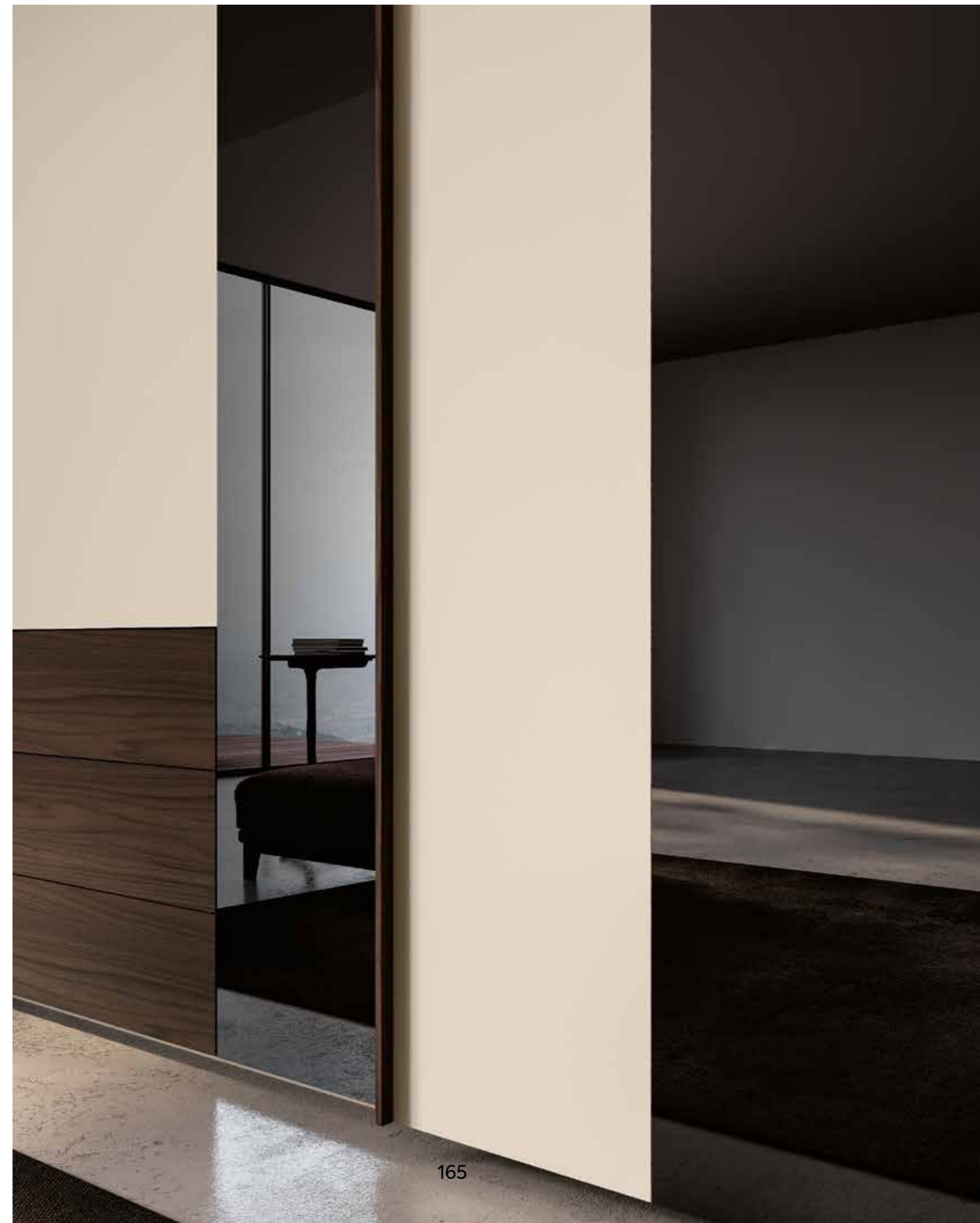

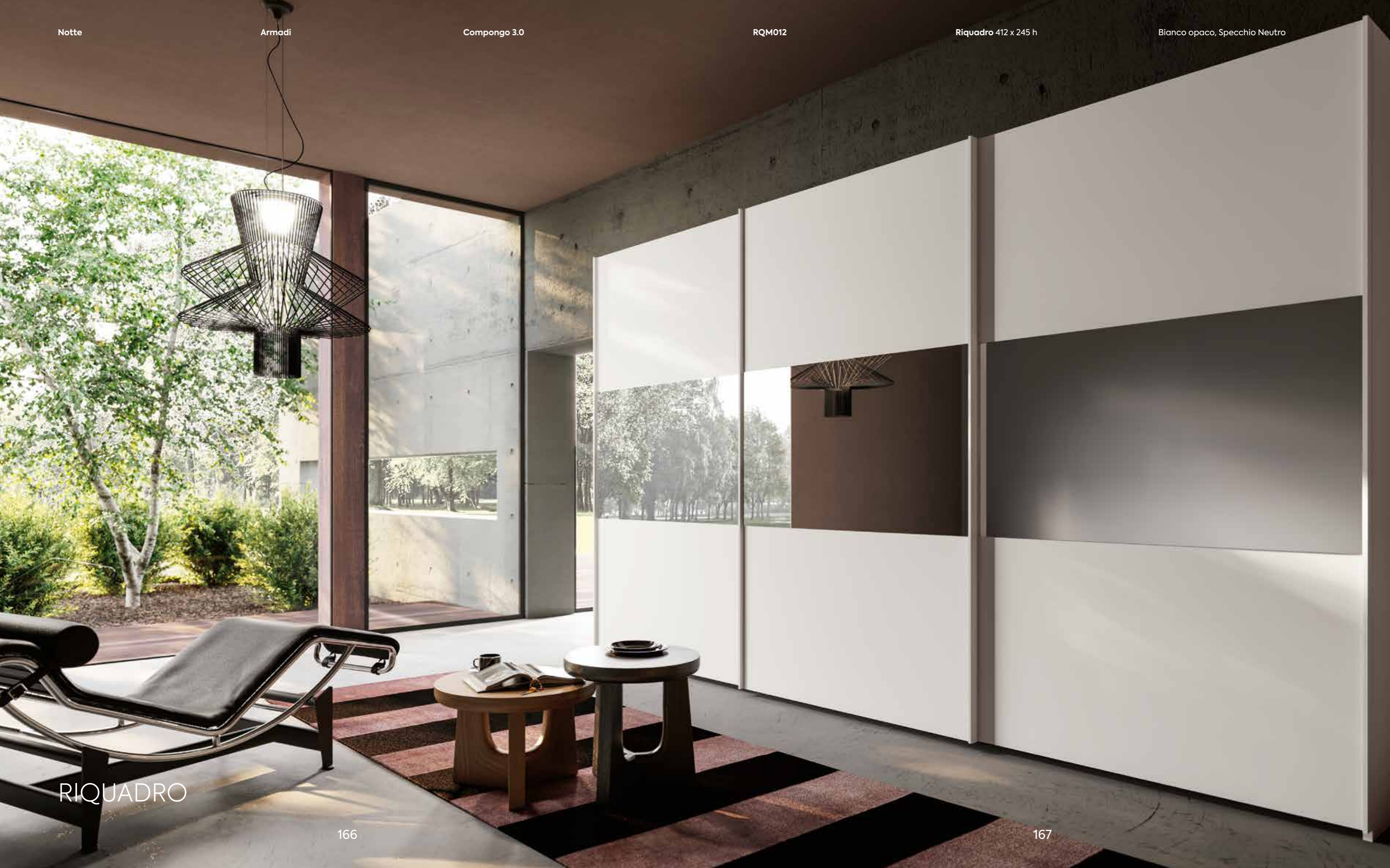

RIQUADRO



RIQUADRO

Technicals

Maniglie che si posizionano solo su anta / Handles for door only / Poignées qui se positionnent uniquement sur porte



Boma*
**Finiture disponibili:
colorati
Finishes available:
colours
Finitions disponibles:
colorées



*Finiture disponibili:
essenze e colorati
Finishes available:
wooden effects and colours
Finitions disponibles:
essences et colorées



Raggio
Nero, Nichel

***Finiture disponibili:
essenze
Finishes available:
wooden effects
Finitions disponibles:
essences



Maniglie che si posizionano su anta e cassetto/cesto / Handles for doors and drawers/storage drawers. / Poignées qui se positionnent sur porte et tiroir/grand tiroir

*Finiture disponibili:
essenze e colorati
Finishes available:
wooden effects and colours
Finitions disponibles:
essences et colorées



Cerchio
Nichel

Cerchio
Nichel



Dub
Nero/Grigio

Dub
Nero/Grigio

**Finiture disponibili:
colorati
Finishes available:
colours
Finitions disponibles:
colorées



Linea
Nichel

Linea
Nichel

Maniglie che si posizionano su anta e cassetto/cesto / Handles for doors and drawers/storage drawers. / Poignées qui se positionnent sur porte et tiroir/grand tiroir



Maniglie speciali / Special handles / Poignées spéciales
Anta specchio / Mirror door / Porte-miroir

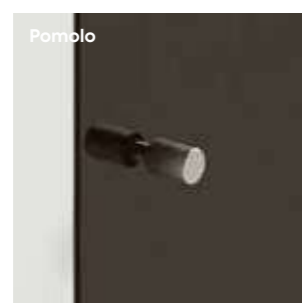

Anta telaio / Frame door / Porte avec cadre



■ P / D / P 35 cm



■ L / W / L 75 cm



■ L / W / L 6 cm

■ L / W / L 35 cm

La collezione Compongo presenta la possibilità di effettuare riduzioni in Profondità.

The Compongo collection offers reduced depth solutions.

La collection Compongo permet d'étudier des solutions pour réduire la profondeur.

Per agevolare l'inserimento di una armadiatura in una dimensione ridotta, anche la Lunghezza può essere ridotta lavorando su un vano.

To facilitate the installation of a reduced-size wardrobe, length may also be reduced by having one compartment.

Pour faciliter l'insertion d'une armoire dans un espace réduit, il est aussi possible de réduire la longueur en intervenant sur un compartiment.

Le due immagini illustrano le casistiche su cui il programma prevede le fasce:

- standard come pannello chiusura (fissa)
- ad uso ripostiglio (apribile)

L'intero programma fuori misura è riportato a listino.

The two images illustrate the cases where the programme offers the categories:

- standard closed panel (fixed)
- for use as a closet (opening)

The entire outside programme is shown as per the price list.

Les deux images illustrent les cas pour lesquels le programme prévoit les gammes :

- standard comme panneau de fermeture (fixe)
- comme placard (ouvrable)

Tout le programme hors série est indiqué dans la liste des prix.

Finiture

Finishes

Finitions

Nobilitati / Melamine / Revêtements mélaminés

Essenze / Wooden effect / Essence

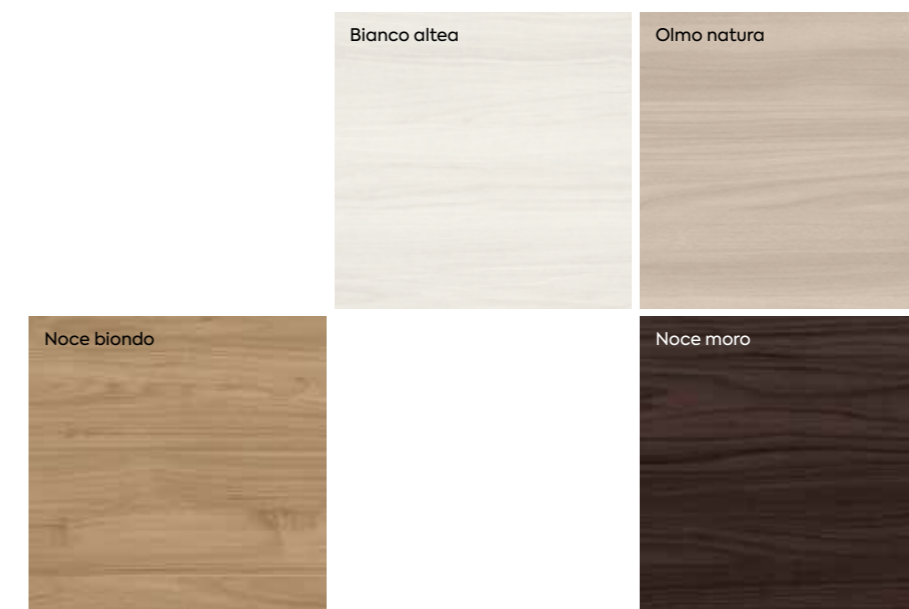

Colorati / Coloured / Coloré



*Per maniglioni ante scorrevoli, fermalibro, reggimensola, maniglia Delta e gamba scrivania / For sliding door handles, book-ends, shelf brackets, Delta handle and desk leg / Pour poignées de portes coulissantes, serre-livres, support d'étagères, poignées Delta et jambe de bureau

Spatolati / Plaster effect / Spatulé



Non disponibili in H 295 / Not available in H 295 / Ne sont pas disponibles en H 295

Laccati / Lacquered / Lacquered

Lucidi / Glossy / Brillant

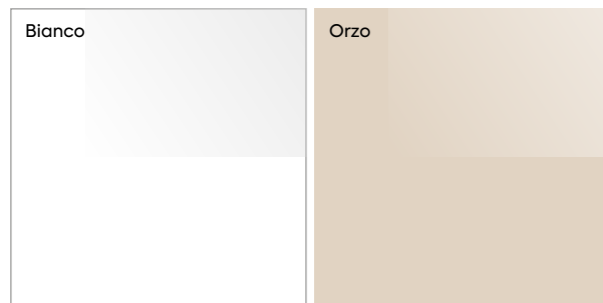

Opachi / Matt / Mat



Inserti / Insert / Inserts

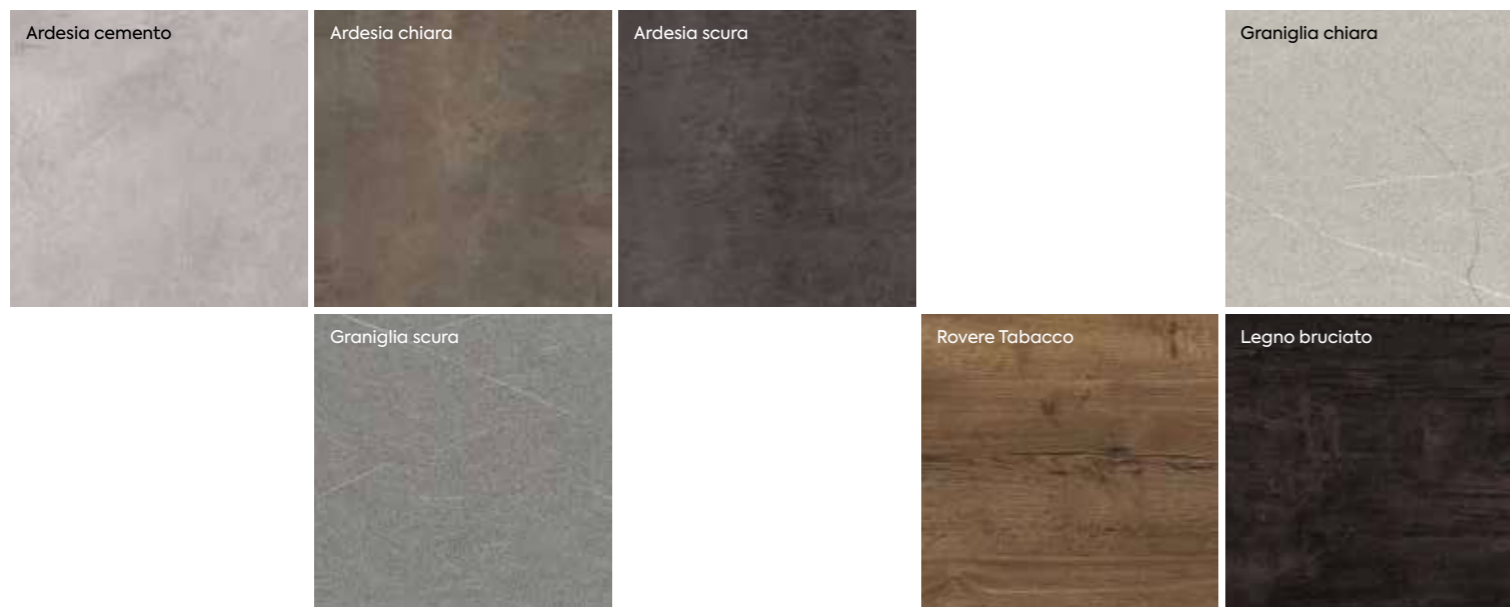

Specchi / Mirrors / Miroirs

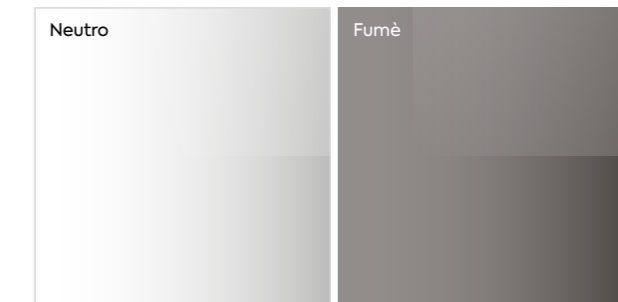
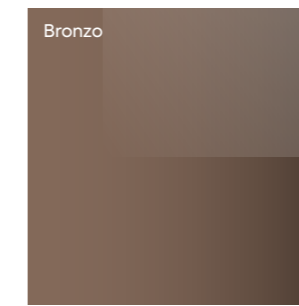

Vetri / Glass / Verres

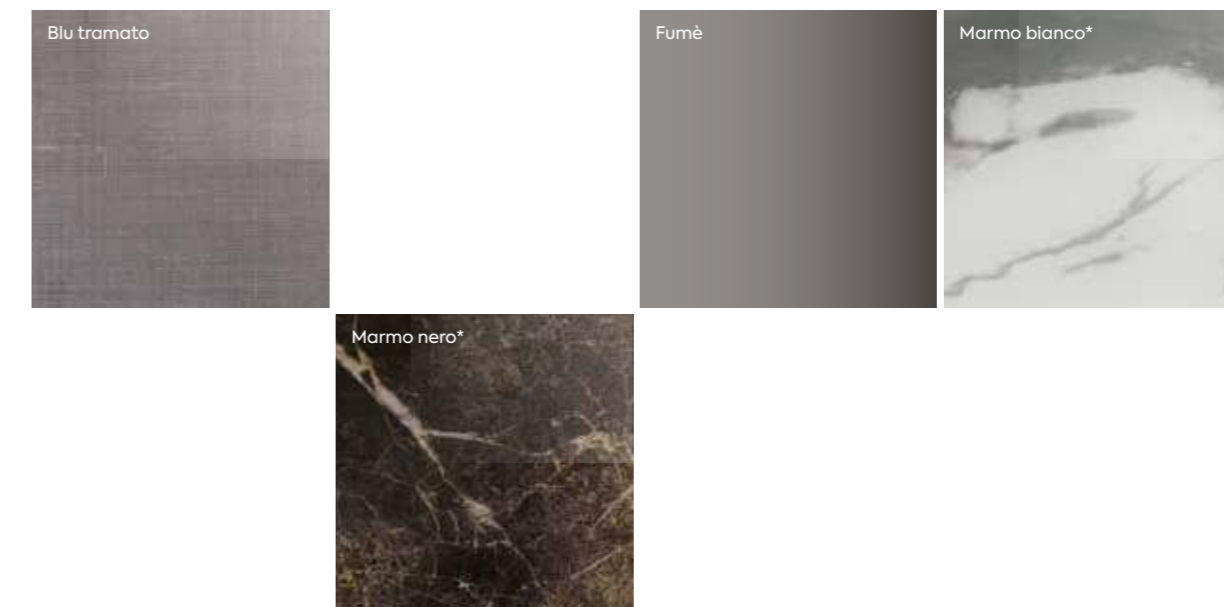

*Non disponibile su telaio onda e frame ma solo come inserto nelle circostanze previste a listino / Not available on "onda" and "frame" frame; only supplied as insert in the situations specified in the price list / Non disponible sur cadre "onda" et "frame" mais seulement comme insert dans les circonstances prévues dans la liste des prix

Il Gruppo Imab nasce nel 1968 dalla passione e dalla tenacia dell'imprenditore Antonio Bruscoli. Nel tempo abbiamo sviluppato e consolidato una mission aziendale unica e ambiziosa: creare uno stile di arredamento che contribuisca al benessere delle persone grazie alla combinazione di Ricerca, Tecnologia, Design Italiano e Capacità Artigianali. La nostra sede si trova a Fermignano, poco distante da Urbino. Proprio qui, nel cuore delle Marche, realizziamo la nostra produzione, ispirandoci a questa terra rigogliosa ricca di storia e tradizione.

The Imab Group was founded in 1968, thanks to the passion and determination of entrepreneur Antonio Bruscoli. Over time, it has developed and consolidated a unique corporate mission: the creation of a style of furniture capable of increasing people's well-being, through a combination of Research, Technology, Italian Design and Skilled Craftsmanship. We are based at Fermignano, not far from Urbino. It is here, in the heart of Italy's Marches region, that we produce our furniture, inspired by this fertile land, rich in history and tradition.

Le Groupe Imab est né en 1968 sous l'impulsion de l'entrepreneur Antonio Bruscoli. Au fil du temps, nous avons développé et consolidé une mission d'entreprise unique et ambitieuse : créer un style de mobilier qui contribue au bien-être des personnes grâce à une combinaison de Recherche, Technologie, Design Italien et Savoir-Faire Artisanal. Notre siège social est situé à Fermignano, près de Urbino. C'est ici, au cœur de la région Marches, que nous fabriquons nos produits, en nous inspirant de cette terre riche, chargée d'histoire et de tradition.

50 anni d'esperienza.

Da oltre 50 Anni copriamo il mercato mondiale, con una produzione 100% made in Italy.

50 years of experience

We have been covering the world market, with 100% Italian-made products, for more than 50 years.

50 ans d'expérience

Depuis plus de 50 ans, nous couvrons le marché mondial, avec des produits 100 % made in Italy.

Abbiamo un cuore italiano.

Il ciclo produttivo dei nostri mobili è totalmente integrato, a partire dalla materia prima di provenienza unicamente italiana, fino al prodotto finito.

We have an Italian heart.

The production cycle for our furniture is totally integrated, starting from the raw materials, all of strictly Italian origin, right through to the finished product.

Nous avons à cœur de produire italien.

Le cycle de production de nos meubles est entièrement intégré, de la matière première d'origine exclusivement italienne au produit fini.

Una casa alla moda.

La nostra mission è di creare un arredo per tutta la casa. Un total living accessibile e in linea con i gusti di tutti.

A fashionable home.

Our mission is to create furniture for the entire home. A total living-space concept, accessible and in line with everyone's taste.

Une maison à la mode.

Notre mission est de créer un mobilier pour toute la maison. Un total living abordable et conforme aux goûts de chacun.

Siamo più di mille!

600 dipendenti e un indotto che conta oltre 1000 persone: una realtà innovativa e consolidata nel mercato mondiale.

More than a thousand of us!

600 employees and a supply chain of more than 1000 people: a major, innovative, consolidated player on the world market.

Nous sommes plus d'un millier !

600 employés et des retombées sur plus de 1000 personnes font de notre Groupe un acteur novateur et bien établi sur le marché mondial.

Una storia di qualità.

Da sempre il Gruppo Imab aderisce a percorsi indirizzati alla qualità dei prodotti e alla tutela dell'ambiente.

A history of quality.

The Imab Group has always implemented strategies intended to ensure product quality and environmental protection.

Une histoire de qualité.

Le Groupe Imab s'est toujours engagé dans une politique de qualité des produits et de protection de l'environnement.

Grandi numeri per un grande progetto.

400.000m² di pannello lavorato in un mese. 130.000m² di superficie coperta. 140 camion distribuiscono nel mondo 90.000 colli di prodotto.

Big numbers for a big project.

400,000m² of boards processed. 130,000m² of buildings. 140 trucks distribute about 90,000 product items worldwide.

De grands chiffres pour un grand projet.

400.000m² de panneaux travaillés en un mois. 130.000m² de surface couverte. 140 camions distribuent 90.000 colis de produits dans le monde entier.

Imab Group per la sostenibilità.

Risparmio energetico e processi produttivi ad elevato livello qualitativo permettono una produzione con prezzi sempre più economici e convenienti mantenendo inalterati i livelli di qualità ed efficienza.

Imab Group for sustainability.

Energy saving and production processes with high quality level enable it to produce with more and more competitive, affordable prices, with exactly the same quality and efficiency levels.

Imab Group pour le développement durable.

Les économies d'énergie et les procédés de production de haute qualité permettent une production à des prix de plus en plus avantageux tout en maintenant les mêmes niveaux de qualité et d'efficacité.



Da sempre sosteniamo l'ambiente con progetti eco-friendly focalizzandoci prevalentemente sulla qualità dei nostri prodotti.

Altissimi livelli di efficienza sono possibili grazie a un risparmio energetico nei processi produttivi.

Crediamo che il sole e le energie rinnovabili possano contribuire al futuro della nostra azienda; per questo abbiamo installato diversi impianti fotovoltaici presso le nostre strutture, in modo che lo standard produttivo della nostra azienda sia perfettamente in linea ai modelli energetici internazionali.

We have always supported the environment with eco-friendly projects, focusing mainly on our products' quality.

Extremely high efficiency levels are possible thanks to energy saving in production processes.

We believe that the sun and renewable energy sources can contribute to our company's future; this is why we have installed several photovoltaic plants at our locations, so that our company's production standard is perfectly in line with international energy models.

Nous avons toujours soutenu l'environnement avec des projets respectueux de l'environnement, axés principalement sur la qualité de nos produits.

Les économies d'énergie réalisées dans les procédés de production permettent d'atteindre des niveaux d'efficacité optimaux.

Nous pensons que le soleil et les énergies renouvelables peuvent contribuer à l'avenir de notre entreprise; c'est pourquoi nous avons installé plusieurs systèmes photovoltaïques dans nos installations, de sorte que le niveau de production de notre entreprise est parfaitement conforme aux modèles énergétiques internationaux.

Energie alternative, per una produzione responsabile.

Alternative energies, for responsible production.

Des énergies alternatives pour une production responsable.



Crediamo che un certificato di qualità non sia solo un riconoscimento, ma una vera responsabilità verso l'ambiente, che con forza portiamo avanti valorizzando e qualificando le strutture produttive in un'ottica carbon neutral, a bassa emissione di Co2. Il nostro impegno è costantemente focalizzato sul territorio e sulla sostenibilità, al fine di poter immettere nel mercato un prodotto che sia responsabile ed ecologico al 100%.

We believe that a quality certification is not just an award but a real responsibility to the environment, which we pursue with determination, upgrading and updating our production plants with a carbon neutral approach, with low Co2 emissions. We are constantly committed to our local community and sustainability, to allow us to offer the market a 100% responsible, environment-friendly product.

Pour nous, un certificat de qualité n'est pas seulement une reconnaissance, c'est une véritable responsabilité envers l'environnement, que nous assumons avec détermination en améliorant et en qualifiant les installations de production dans une perspective de carbone neutre, avec de faibles émissions de CO2. Notre engagement est constamment focalisé sur le territoire et sur la durabilité, afin de pouvoir mettre sur le marché un produit responsable et 100 % écologique.



La promessa che facciamo a tutti i nostri clienti è fornire prestazioni eccellenti senza rinunciare all'integrità ambientale, sviluppando l'intero ciclo produttivo in Italia per garantire il 100% del risultato in originalità, design e valore. Il forte orientamento all'innovazione è il motore portante della collaborazione con il Gruppo Loccioni, integratore di tecnologie riconosciuto a livello mondiale e leader nell'efficiamento energetico di prodotti, processi e building.

We promise all our customers excellent performance without sacrificing environmental integrity, carrying out the entire production cycle in Italy to guarantee the very best results in terms of originality, design and value. Our strong orientation towards innovation is the driving force behind our partnership with the Loccioni Group, world famous technology integrator and leader in the energy efficiency upgrading of products, processes and buildings.

La promessa che nous faisons à tous nos clients : fournir d'excellentes performances dans le respect de l'environnement, en développant tout le cycle de production en Italie pour assurer 100 % du résultat en originalité, design et valeur. La forte orientation vers l'innovation est le moteur de la collaboration avec le Groupe Loccioni, intégrateur technologique de renommée mondiale et leader dans le domaine de l'efficacité énergétique des produits, procédés et bâtiments.



Presso la sede principale di Imab Group è stato installato un Leaf Meter: il misuratore di sostenibilità che comunica in tempo reale i dati relativi alle performance energetiche e all'impatto ambientale degli edifici interessati.

A Leaf Meter, the sustainability meter that reports the energy performance and environmental impact data of the relevant buildings in real time, has been installed at the Imab Group headquarters.

Un Leaf Meter a été installé au siège du Groupe Imab : le compteur de durabilité qui fournit des données en temps réel sur la performance énergétique et l'impact environnemental des bâtiments concernés.

© 2020 IMAB GROUP

All rights reserved. È vietata la riproduzione anche parziale del seguente catalogo senza autorizzazione scritta da parte dell'Azienda.

L'Azienda si riserva il diritto, in ogni momento e senza preavviso, di apportare modifiche alle specifiche dei Prodotti atte a migliorarne l'utilizzo. Le fotografie e le descrizioni presenti sui nostri siti internet o sul nostro catalogo non hanno valore contrattuale. Ci riserviamo di modificare il prodotto anche senza preavviso per migliorarne il funzionamento.

Tutti i diritti di quanto contenuto nel presente file appartengono a Imab Group S.p.A. in via esclusiva. È vietata la copia, la pubblicazione, la distribuzione o la riproduzione (anche parziale), se non autorizzata per iscritto.

Design

Gino Brini

AD

Eikon

Fotolito

Mic Studio

Stampa

Antezza Tipografia

Codice: Z2200300

Codice listino prezzi: 00

Collezione: compongo

Testatina: G1A00

Uscita pubblicazione: 09/2020





Imab Group S.p.A.
Via L. Falasconi, 92
61033 Fermignano (PU) - ITALY
tel. +39 0722 335 701
www.imab.com