

EDGES
WARMING YOUR STYLISH LIVING



Ottimo

Meneghello Paoelli Associati i designer

Sandro Meneghello e Marco Paoelli, entrambi classe 1979, si sono laureati con lode al Politecnico di Milano, Facoltà del Design, nel 2004, sotto la guida di eccelsi designer. Si riuniscono dopo diverse esperienze internazionali e dal 2005 collaborano con aziende italiane ed estere di fama internazionale. I loro prodotti sono stati esposti in tutto il mondo, e durante i loro dieci anni di attività hanno ricevuto vari riconoscimenti internazionali, tra cui 4 Red Dot Design Award (di cui 1 vinto nel 2014 con Ridea, marchio di Radiatori 2000 Spa), 2 Design Plus, 2 Good Design Award, un ADI Design Index, una menzione speciale per il German Design Award e sei menzioni allo Young&Design.

Meneghello Paoelli Associati the designers

Sandro Meneghello and Marco Paoelli, both born in 1979, graduated at the Politecnico di Milano, Faculty of Design, in 2004, under the guidance of influent designers. They separately gather different international experiences since 2005 they have collaborated with several Italian and foreign companies. During their ten years of collaboration, they have received several international recognitions, including four Red Dot Design Award (1 with Ridea, brand of Radiatori 2000 Spa), two Design Plus, two Good Design Award, one ADI Design Index, a special mention for the German Design Award and six mention to the Young&Design.

*... è un oggetto senza tempo
che trasmette sensazioni di novità e
gradevolezza per abitazioni
classiche o di design...*

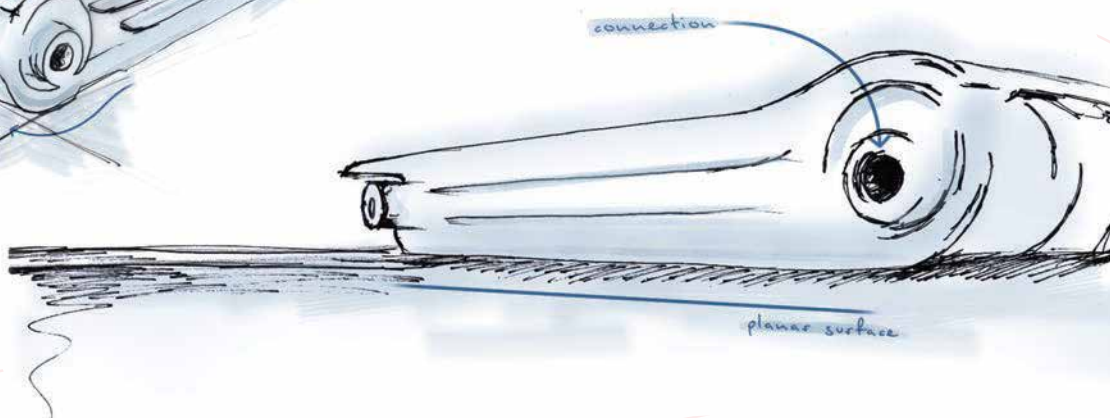
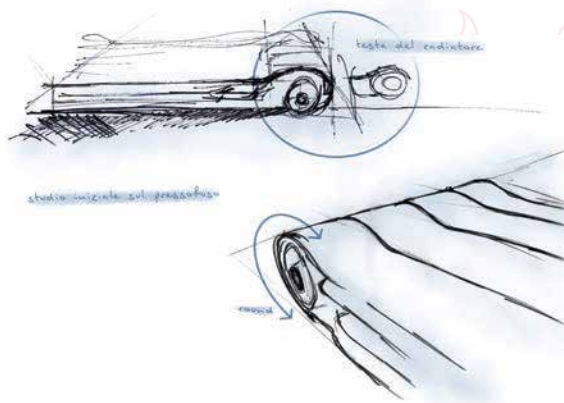
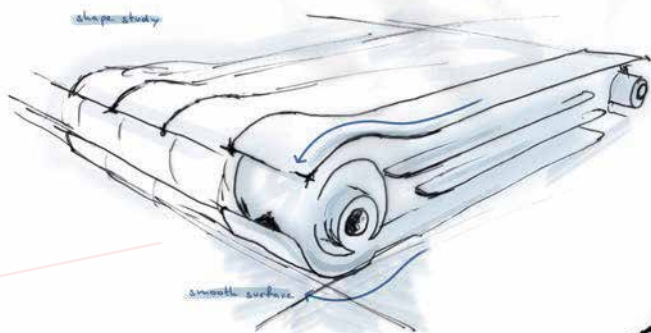

red dot design award
winner 2016

Ottimo

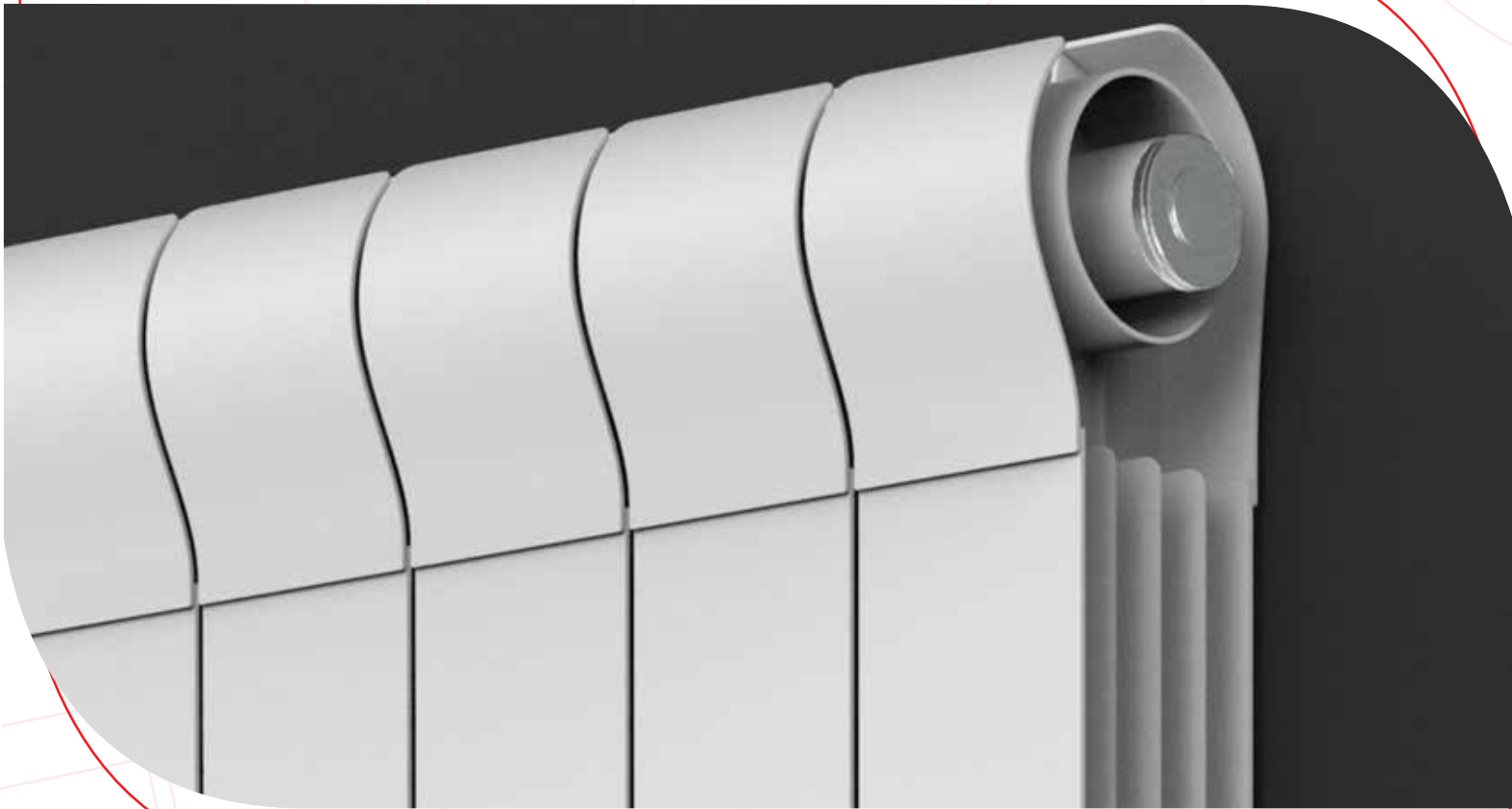

OTTIMO represents the Italian excellence in the field of heating. Through an entire production made in Italy, a very strong sustainable culture and a continuous technological innovation is able to offer a wide range of radiators very efficient and with a pleasing aesthetic: Ottimo, the first design die-cast in the world!

OTTIMO

Radiatori 2000 rappresenta l'eccellenza italiana nel settore del riscaldamento. Grazie ad una produzione Made in Italy, una forte cultura sostenibile e una continua innovazione tecnologica è in grado di offrire una vasta gamma di radiatori molto efficienti e con un'estetica piacevole e curata: Ottimo, il primo radiatore pressofuso di design al mondo!



- Radiatori 2000 represents the Italian excellence in the field of heating. Through an entire production made in Italy, a very strong sustainable culture and a continuous technological innovation is able to offer a wide range of radiators very efficient and with a pleasing aesthetic: Ottimo, the first design die-cast in the world!

MODELLO model	h (mm) altezza height	b (mm) larghezza width	i (mm) interesse center distance	p (mm) profondità depth	peso weight kg	contenuto d'acqua water content lt	resa termica /thermal outputw		
							Δt 30°	Δt 50°	Δt 60°
500	598	80	500	103	1,4	0,5	54,1	103,2	129,9
600	698	80	600	103	1,6	0,5	62,1	118,6	149,4
800	898	80	800	103	2,1	0,7	76,8	149,2	189,1

ACCESSORI / ACCESSORIES

Set Basic valvola e detentore
Basic valve and detentor set

4 tappi di design
4 design caps

Finitura fotografata in queste pagine / Finish photographed on these pages:
Noir Sablé 200 - White 9016 Glossy

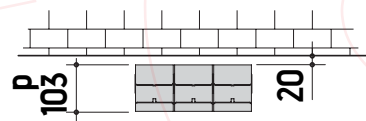
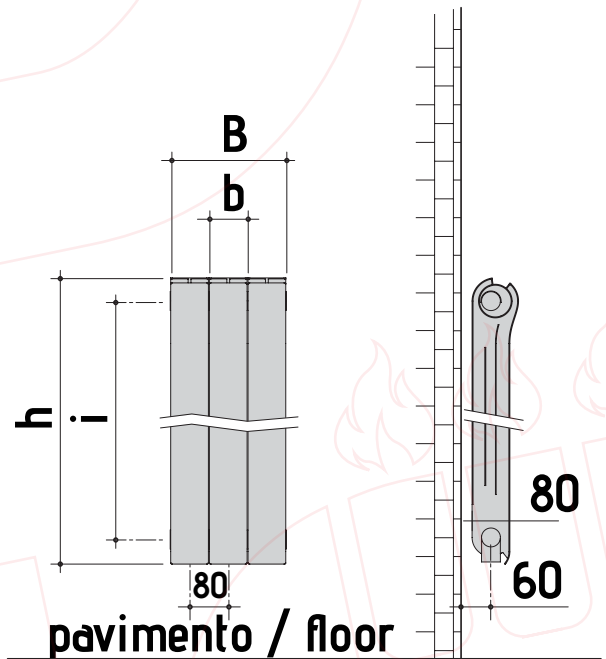

$$B = (8 \times N) + 20 \text{ mm}$$

$$N = (\text{max } 14) \text{ n}^\circ \text{ elementi batteria}$$

$$\text{max } 14) \text{ n}^\circ \text{ elements battery}$$



ALLACCIAMENTI / CONNECTIONS

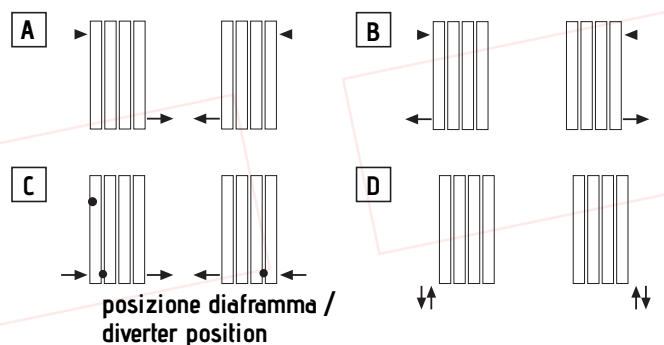

FINISHES

COLORS AVAILABLE

FINITURE BASE . BASIC FINISHES



STANDARD
RAL 9016 sablé
Bianco / White



SW3051 sablé (+5%)
Nero / Black

FINITURE DISPONIBILI A RICHIESTA . FINISHES AVAILABLE ON REQUEST

19 VERNICIATURE RAL . RAL PAINTS



RAL 7035
Grigio luce



RAL 7005
Grigio topo



RAL 7044
Grigio seta



RAL 7023
Grigio calcestruzzo



RAL 7006
Grigio beige



RAL 7039
Grigio quarzo



RAL 7016
Grigio antracite



RAL 9016
Bianco traffico



RAL 9010
Bianco puro



RAL 1013
Bianco perla



RAL 9005
Nero profondo



RAL 5003
Blu zaffiro



RAL 5024
Blu pastello



RAL 6004
Verde blu



RAL 6005
Verde muschio



RAL 5020
Blu oceano



RAL 3015
Rosa chiaro



RAL 3017
Rosa



RAL 4002
Rosso violetto



RAL 8002
Marrone segnale



RAL 8004
Marrone rame



RAL 8015
Marrone castano



RAL 2001
Rosso arancio

20 FINITURE E VERNICIATURE SPECIALI . FINISHES AND SPECIAL PAINTS



SW327F
Blu 500 sablé



SW305F
Blu 700 sablé



MW136E
Gold



SW205F
Bronze



SW208F
Marron d'Inde



SAP 10020
Champagnafrosty



M30001
Nickel



SAP 13931
Silver satin



MX302L
Bismuth



SW306F
Noir 200 sablé



SN351F
Noir 900 sablé



RAL 9010
Bianco puro

+20% sul prezzo standard / +20% on standard price

FINITURE SPECIALI . SPECIAL FINISHES



Anodizzato
Anodized



Sfumato
Faded



Lucidato
Lux



Foglia oro
Gold leaf



Foglia argento
Silver leaf

Vedere sovrapprezzo nelle schede tecniche / See price on the technical sheets

40 FINITURE ANODIZZATE METALLIZZATE A CATALOGO . METALLIC ANODIZED FINISHES ON CATALOGUE

Solo per modelli ROUND-AL BATH, CUBE-AL BATH, OV-AL BATH, TOWEL BAR, OV-AL SLIM, OV-AL HORIZONTAL
Only for models ROUND-AL BATH, CUBE-AL BATH, OV-AL BATH, TOWEL BAR, OV-AL SLIM, OV-AL HORIZONTAL



TX2426
Oro rosa



TX2407
Cromato bianco



TX2133
Extrafine champagnafrosty



TX2022
Metal extrafine



TX2422
Anodica ottone

+40% sul prezzo standard
+40% on standard price



+2 0110 177 7751

www.EdgesHeating.com

Infor@solaredges.com

2 Ext 26 July St . Lebnan Sq .

El Hawary Tower , Mohandessin

Giza 12654 - Egypt



@EdgesSolar



@Edges Heating Systems & Solar Energy

www.EdgesHeating.com



www.EdgesHeating.com